

Scan and Login website
for more information



- Certified Management System
- EN ISO 9001
- EN ISO 13485

TIP BOOK



Contents

Periodontal treatment device

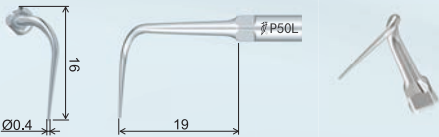
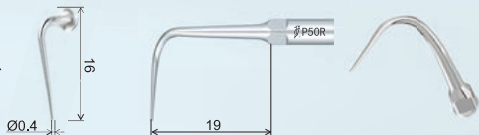
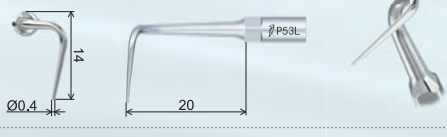
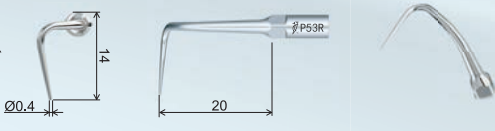
Model			Page
P50L			1
P50R			2
P52			3
P53L			4
P53R			5

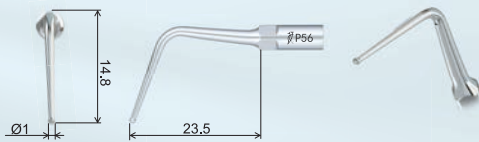
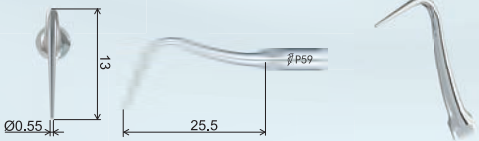
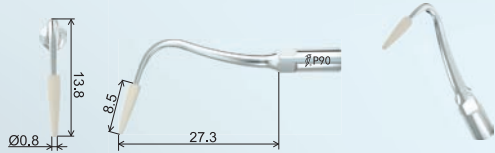
Model			Page
P56			6
P59			7
P90			8

Dimensions Unit: mm



***SPOILING YOU
SO MUCH!***



Scaling

Model

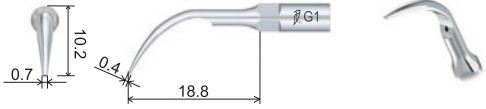
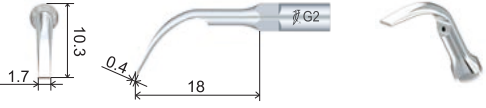
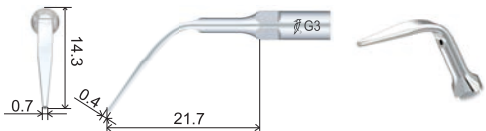
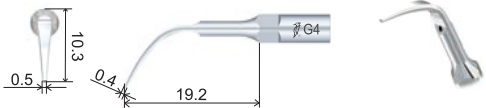
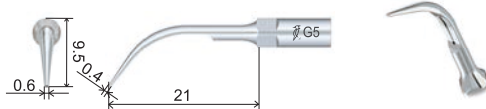

Page

G1		9
G2		10
G3		11
G4		12
G5		13
G6		14

Dimensions Unit: mm

Model

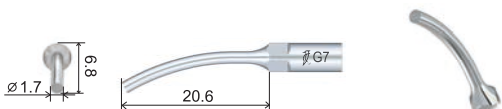
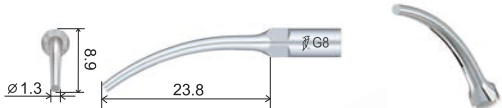
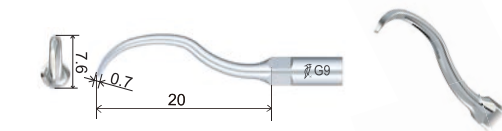
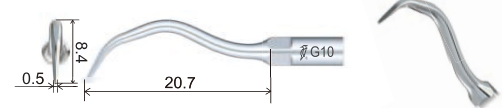
Page

G7		15
G8		16
G9		17
G10		18
G11		19
G12		20

Inlay Preparation

Model		Page
G20		21
G21		22
G30		23
G31		24
G32		25
G33		26

Periodontics

Dimensions Unit: mm

Model		Page
P1		27
P2L		28
P2LD		29
P2R		30
P2RD		31
P3		32

Periodontics

Model

Page

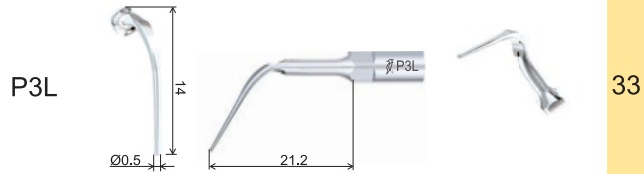

33

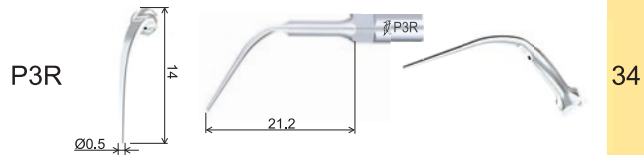

34

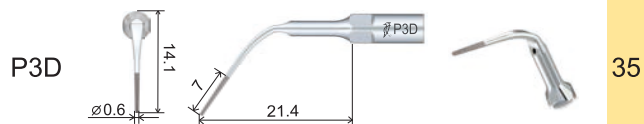

35

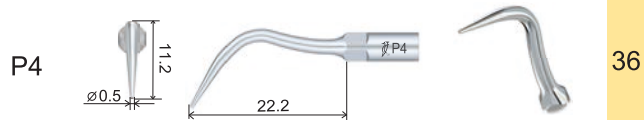

36

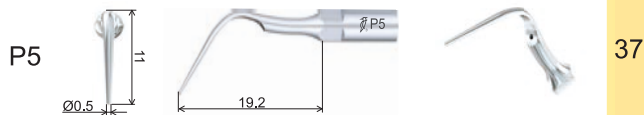

37

Dimensions Unit: mm

Model

Page

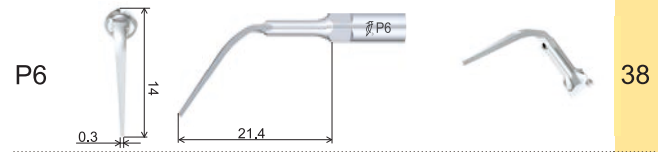

38

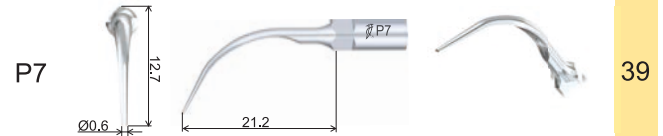

39

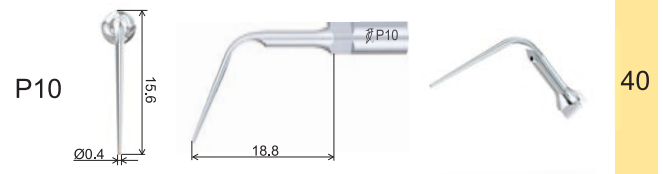

40

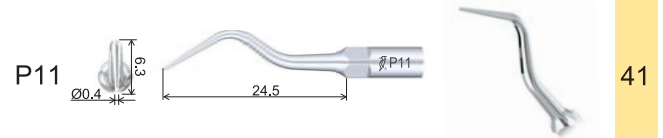

41

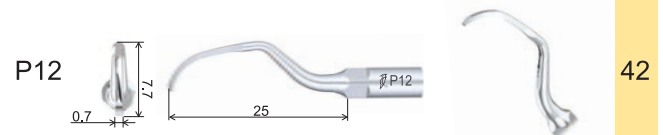

42

Periodontics

Model

Page

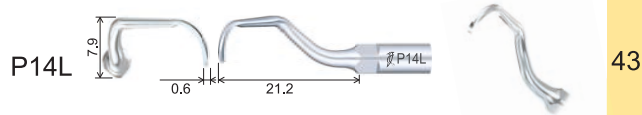

43

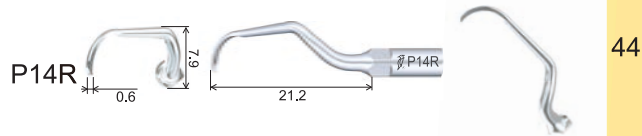

44

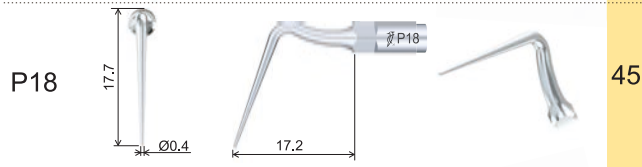

45

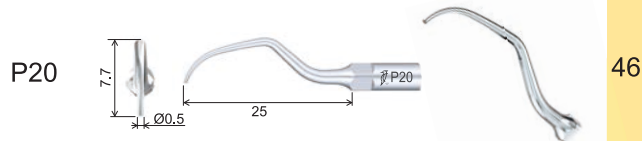

46

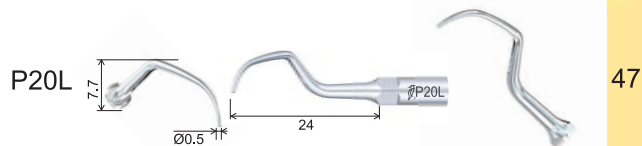

47

Dimensions Unit: mm

Model

Page

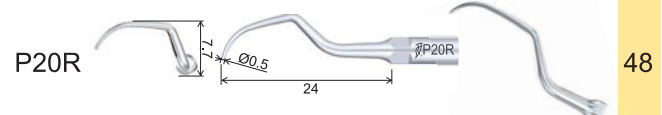

48

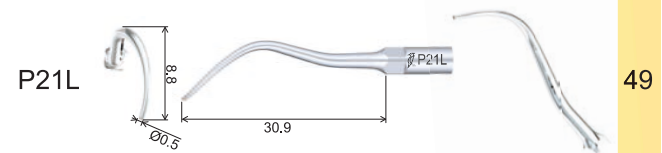

49

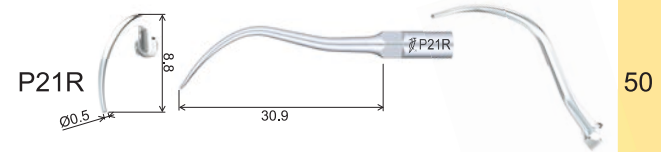

50

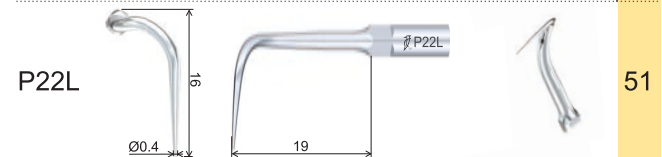

51

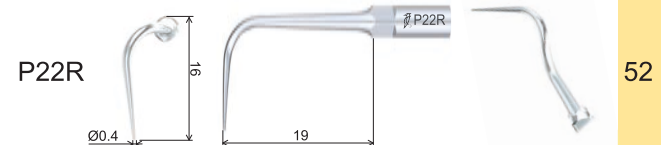

52

Endodontics

Model		Page
E1		53
E2		54
E3		55
E3D		56
E4		57

Dimensions Unit: mm

Model		Page
E4D		58
E5		59
E5D		60
P4D		61

Endodontics

Model

Page

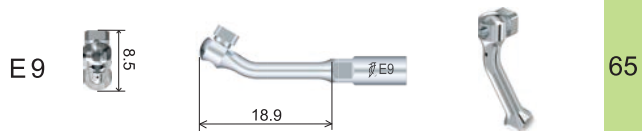
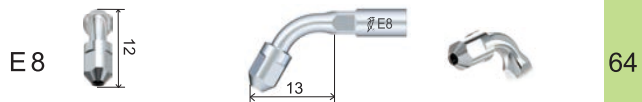
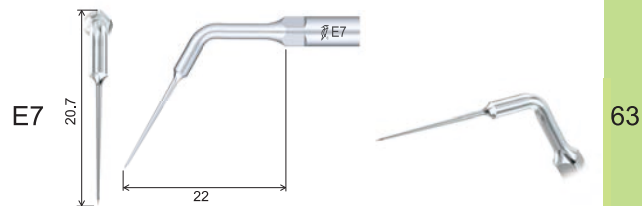
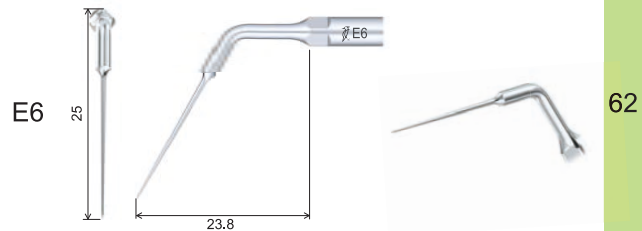

Dimensions Unit: mm

Model

Page

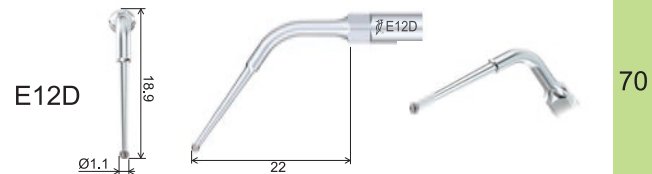
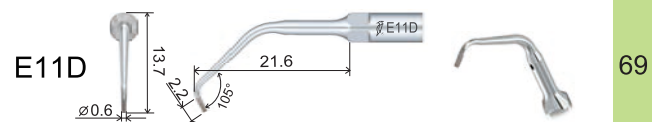
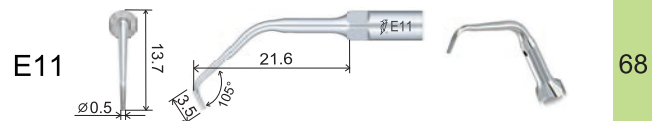
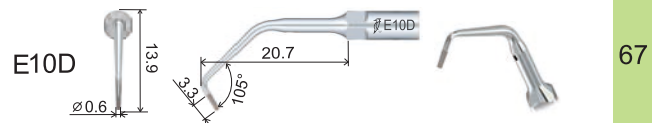
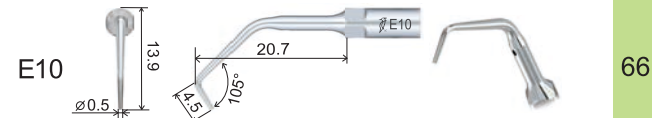

Endodontics





Model	Page
<p>E14</p>	71
<p>E14D</p>	72
<p>E15</p>	73
<p>E15D</p>	74

Cavity preparation

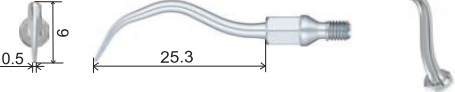
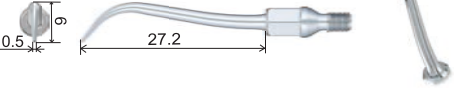
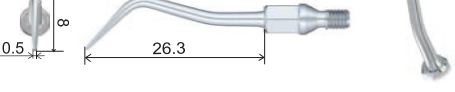

Dimensions Unit: mm

Model	Page
<p>SB1</p>	75
<p>SB2</p>	76
<p>SB3</p>	77
<p>SBL</p>	78
<p>SBR</p>	79

Scaling

Model		Page
GK1		80
GK2		81
GK3		82
GK4		83
GK5		84
GK6		85

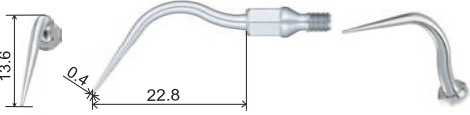
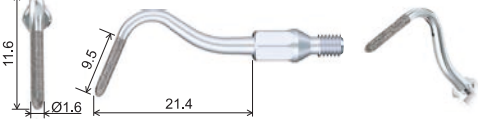
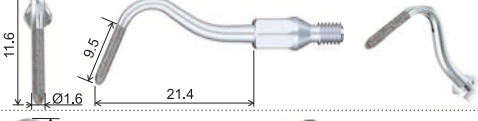
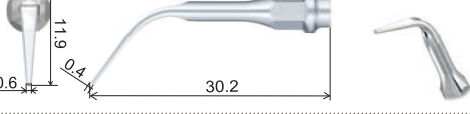
Dimensions Unit: mm

Model		Page
GK7		86
GK20		87
GK21		88
GC1		89
GC2		90
Periodontics		
PC1		91

Scaling

Model		Page
A1		92
A2		93

Bone surgery

US1		94
US1L		95
US1R		96
US2		97

Dimensions Unit: mm

Model		Page
US3		98
US4		99
US5		100
US6		101
US13		102
US21		103
US25		104

Sinus lifting

Model	Page
<p>UL1</p>	105
<p>UL2</p>	106
<p>UL3</p>	107
<p>UL4</p>	108
<p>UL5</p>	109

Dimensions Unit: mm

Model	Page
<p>UL8</p>	110

Endodontics

<p>UE1</p>	111
<p>UE2</p>	112
<p>UE3</p>	113
<p>UE4</p>	114

Exelcymosis

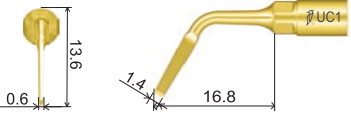
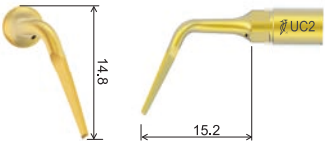
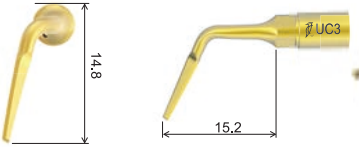
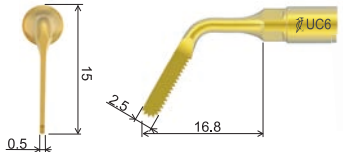
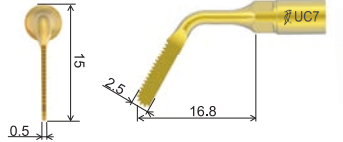
Model		Page
UC1		115
UC2		116
UC3		117
UC6		118
UC7		119

Implantaion

Dimensions Unit: mm

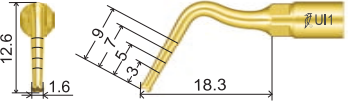
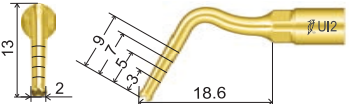
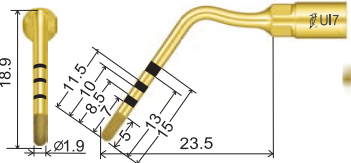
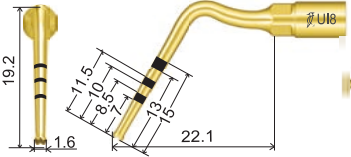
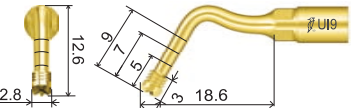
Model		Page
UI1		120
UI2		121
UI7		122
UI8		123
UI9		124

Periodontal surgery

Model		Page
UP1		125
UP2		126
UP3		127
UP4		128
UP5		129

Dimensions Unit: mm

Model		Page
UP6		130
UP7		131

***SPOILING YOU
SO MUCH!***



P50L

Volume of water: Ensure the cooling water reach the end of the tip.

Functional Description: Explore subgingival calculus, root planing and subgingival scaling.

Applicable area: Teeth adjacent part

Operation method: The tip is perpendicular to the long axis of the tooth, The front or back 2mm tip needle part adapt the tooth surface. Move the tip up and down.

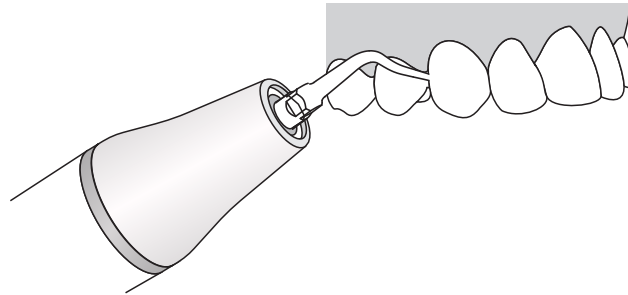
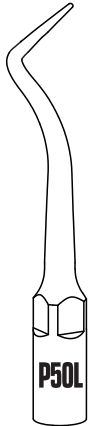

MODE: P
POWER

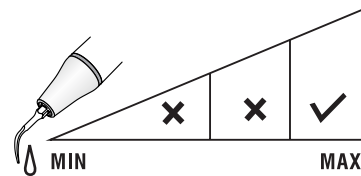
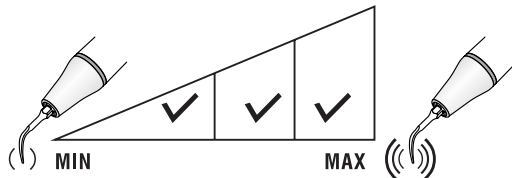

IRRIGATION



P50R

Volume of water: Ensure the cooling water reach the end of the tip.

Functional Description: Explore subgingival calculus, root planing and subgingival scaling.

Applicable area: Teeth adjacent part

Operation method: The tip is perpendicular to the long axis of the tooth, The front or back 2mm tip needle part adapt the tooth surface. Move the tip up and down.

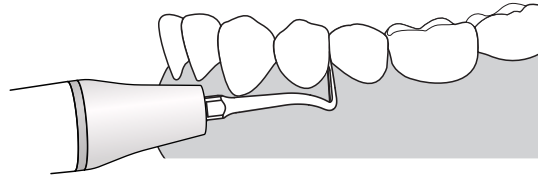

MODE: P
POWER

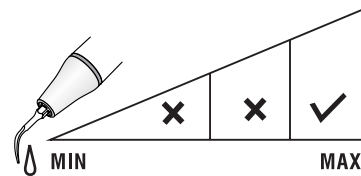
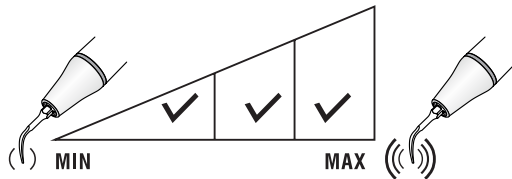

IRRIGATION

P52

Volume of water: Ensure the cooling water reach the end of the tip

Functional Description: For gingival scaling

Applicable area: All teeth buccal and lingual site

Operation method: The tip is parallel to the long axis of the tooth, and ensure the 2 mm right or left tip middle site adapt the tooth surface. Move the tip front and back.

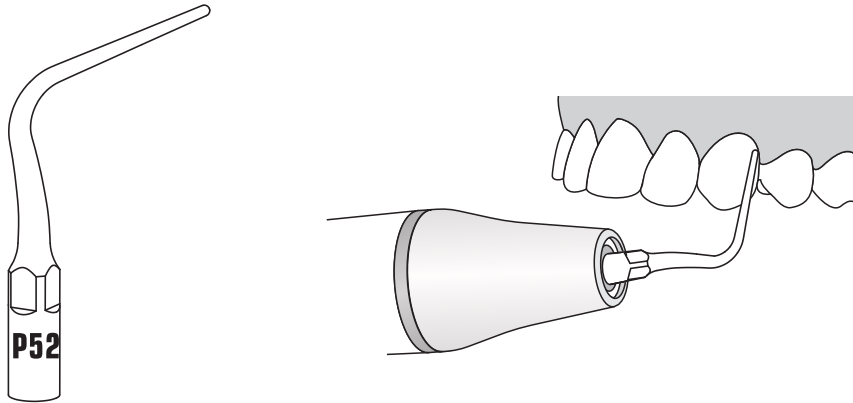

MODE: P
POWER

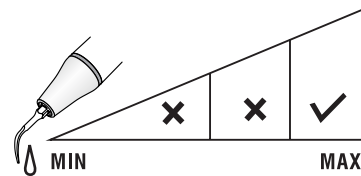
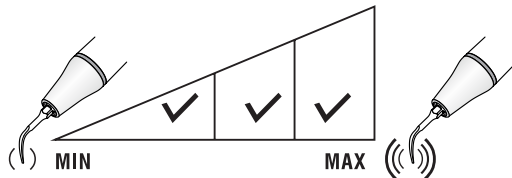

IRRIGATION

P53L

Volume of water: Ensure the cooling water reach the end of the tip.

Functional Description: Explore subgingival calculus, root planing and subgingival scaling.

Applicable area: Teeth adjacent part

Operation method: The tip is perpendicular to the long axis of the tooth, The front or back 2mm tip needle part adapt the tooth surface. Move the tip up and down.

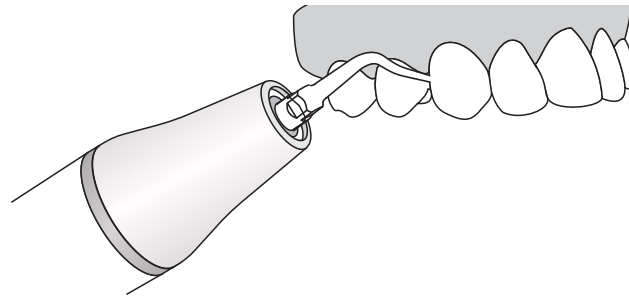
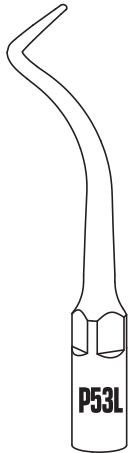

**MODE: P
POWER**

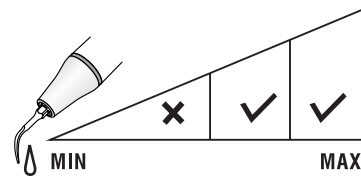
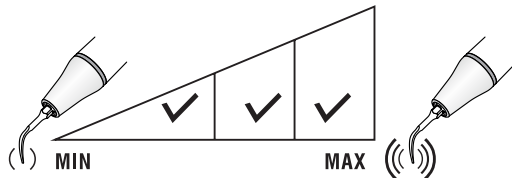

IRRIGATION



P53R

Volume of water: Ensure the cooling water reach the end of the tip.

Functional Description: Explore subgingival calculus, root planing and subgingival scaling.

Applicable area: Teeth adjacent part

Operation method: The tip is perpendicular to the long axis of the tooth, The front or back 2mm tip needle part adapt the tooth surface. Move the tip up and down.

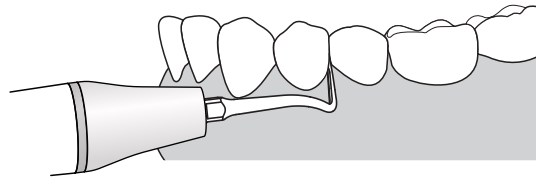
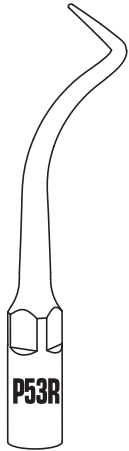

MODE: P
POWER

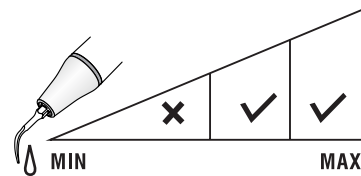
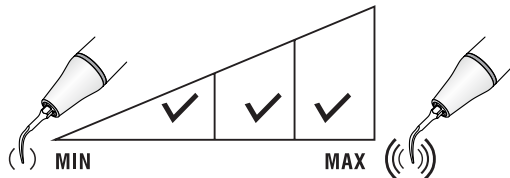

IRRIGATION

P56

Volume of water: Ensure the cooling water reach the end of the tip

Functional Description: Used for gingival large stones and dental plaque

Applicable area: All teeth buccal and lingual site.

Operation method: The tip is parallel to the long axis of the tooth, and ensure the 2 mm right or left tip niddle site adapt the tooth surface. Move the tip front and back.

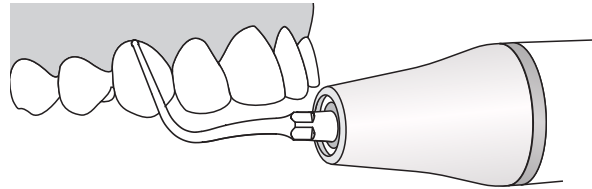
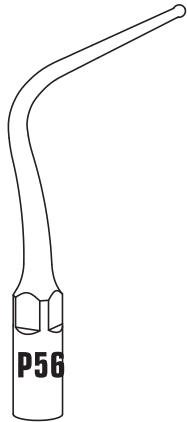

MODE: P
POWER

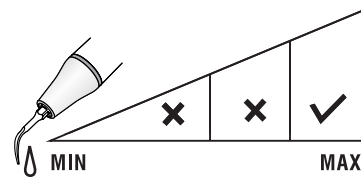
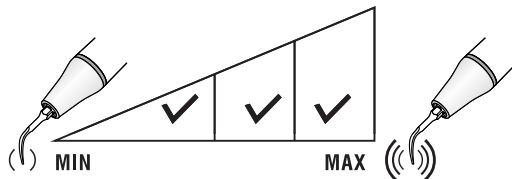

IRRIGATION

P59

Volume of water: Ensure the cooling water reach the end of the tip

Functional Description: For subgingival calculus probing, subgingival scaling and root planing

Applicable area: All teeth buccal and lingual site

Operation method: The tip is parallel to the long axis of the tooth, and ensure the 2 mm right or left tip niddle site adapt the tooth surface. Move the tip front and back.

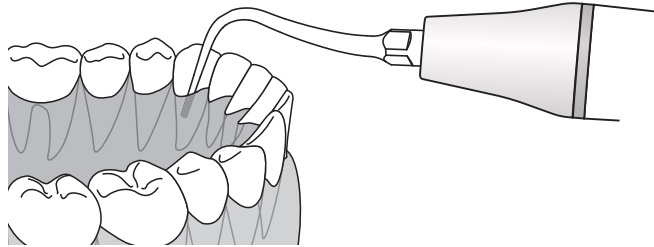

MODE: P
POWER

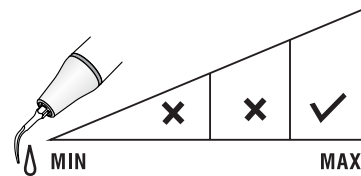
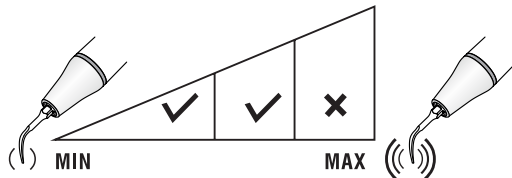

IRRIGATION

P90

Volume of water: Ensure the cooling water reach the end of the tip

Functional Description: Used for gingival large stones and dental plaque

Applicable area: All teeth buccal and lingual site of dental implant or prosthesis.

Operation method: The tip is parallel to the long axis of the tooth, and ensure the 2 mm right or left tip middle site adapt the tooth surface. Move the tip front and back.

Warn: Please ensure that there is water coming out from the handpiece to avoid damage to the tip

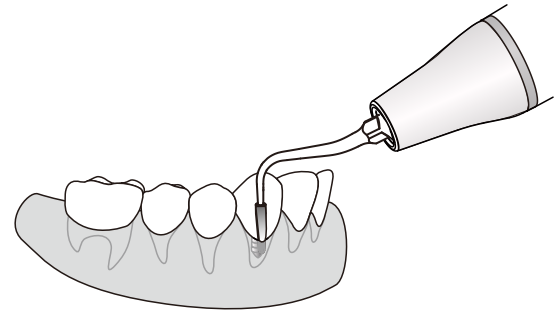
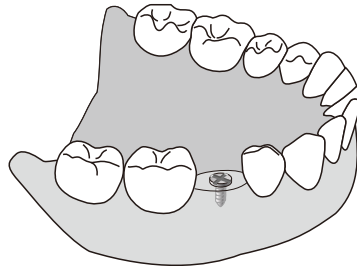

MODE: P
POWER

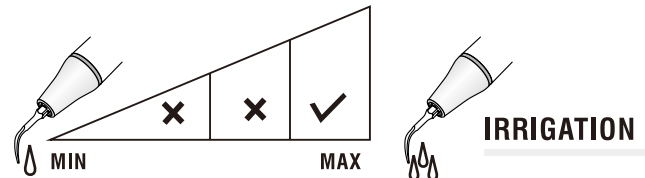
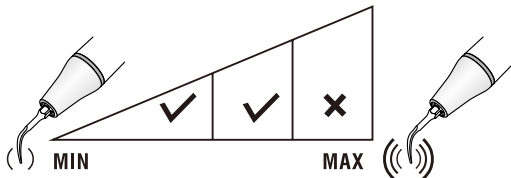

G1 (GD1/GS1)

Removal of supragingival deposits in all quadrants.

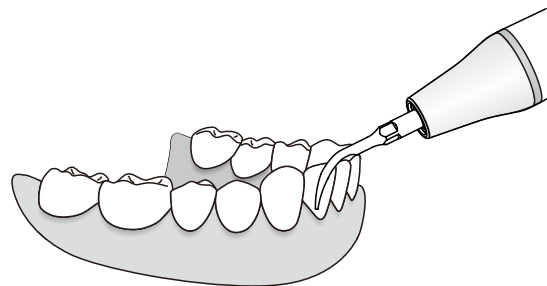
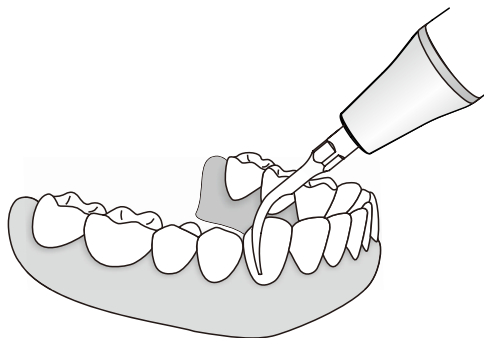
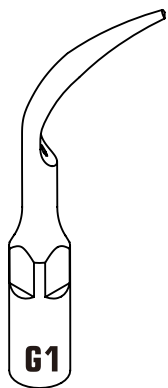

MODE: G
POWER

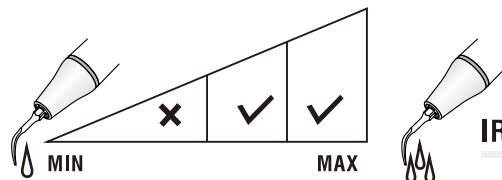
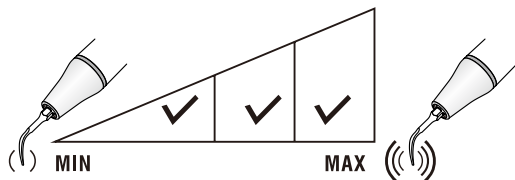

IRRIGATION

G2 (GD2/GS2)

Removal of heavy supragingival deposits.
Apply flat end to surface of teeth.

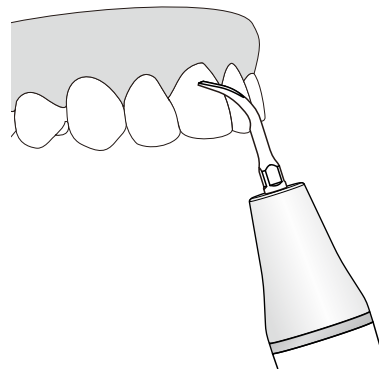
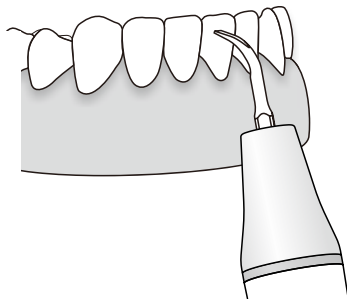
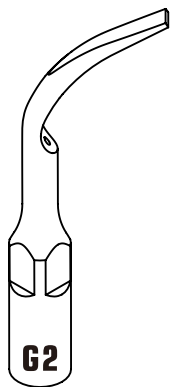

MODE: G
POWER

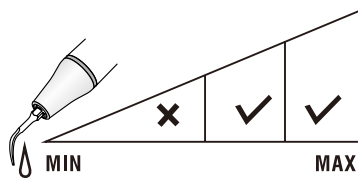
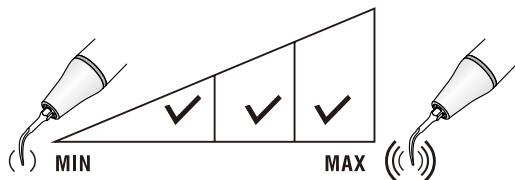

IRRIGATION

G3 (GD3/GS3)

Removal of supragingival deposits in all quadrants, including the interproximal and sulcus areas.

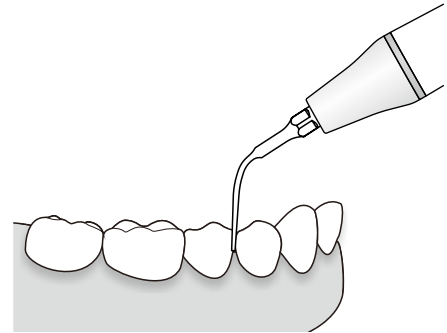
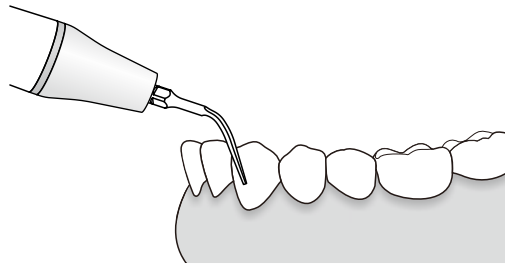
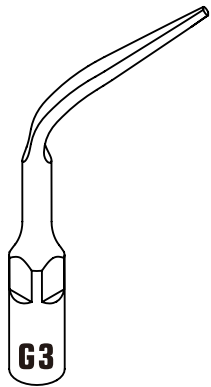

MODE: G
POWER

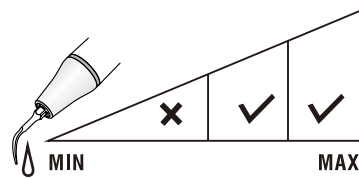
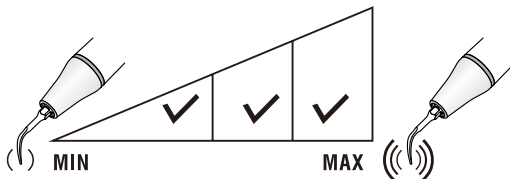

IRRIGATION

G4(GD4/GS4)

Recommended for the treatment of interproximal spaces and for supragingival scaling.

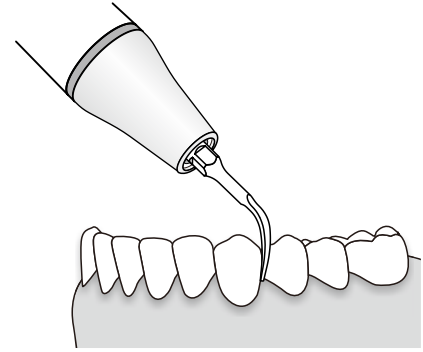
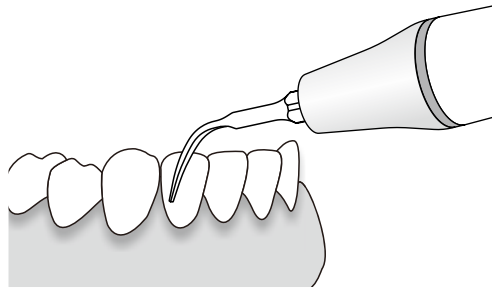
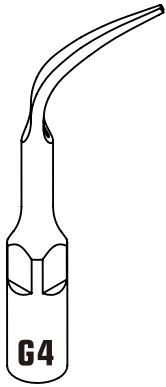

MODE: G
POWER

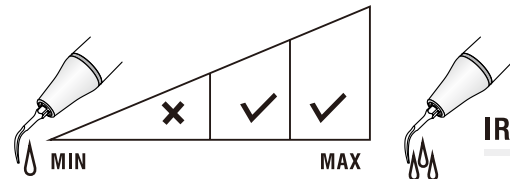
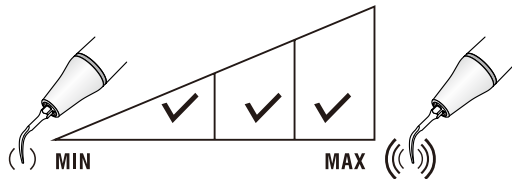

IRRIGATION

G5 (GD5/GS5)

Recommended for treating simple cases and gross supragingival scaling.

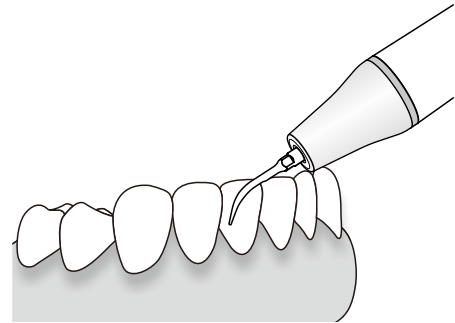
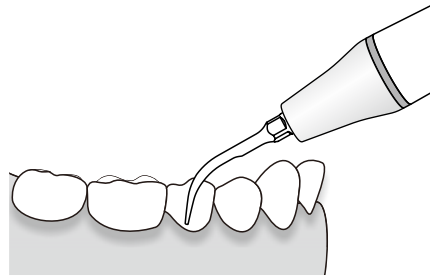
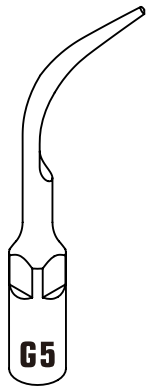

MODE: G
POWER

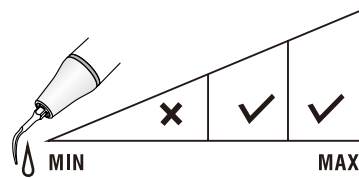
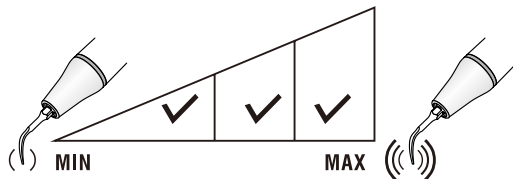

IRRIGATION

G6 (GD6/GS6)

Recommended for removing voluminous supragingival deposits.
Apply flat end to surface of teeth.

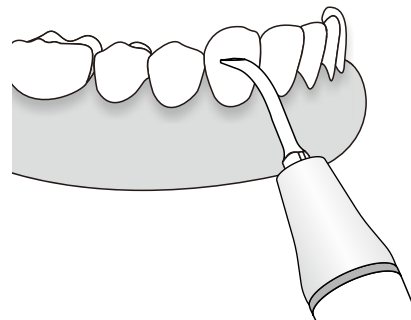
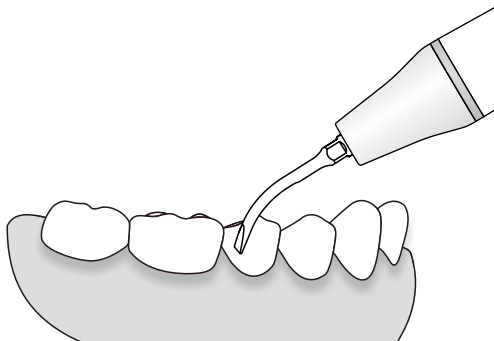
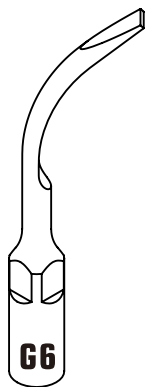

MODE: G
POWER

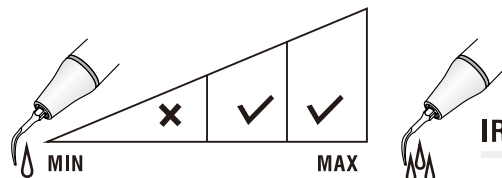
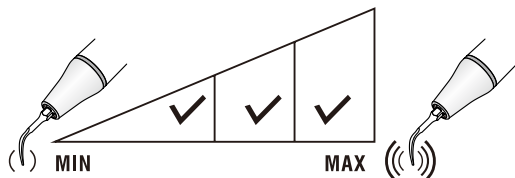

G7 (GD7/GS7)

Removal of crowns.

Apply the instrument onto surface and activate. Increase pressure until vibrations can no longer be heard and maintain for few seconds.

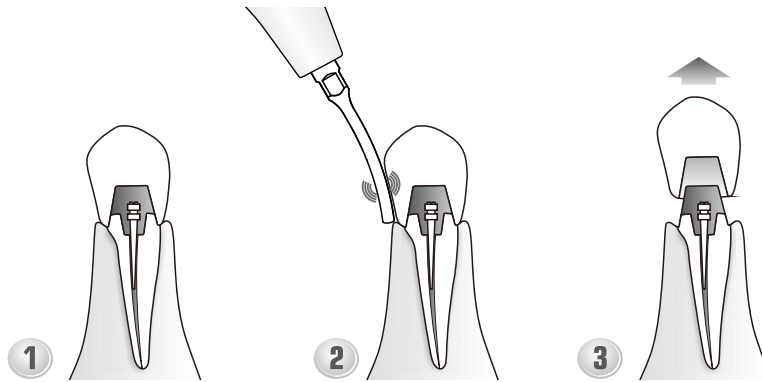
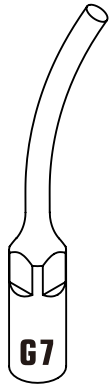

MODE: G
POWER

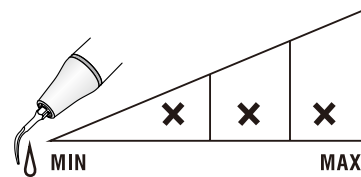
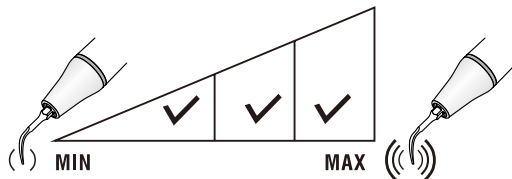

IRRIGATION

G8 (GD8/GS8)

Removal of posts.

Ultrasonic high efficiency for the removal of the difficult prosthetic parts.

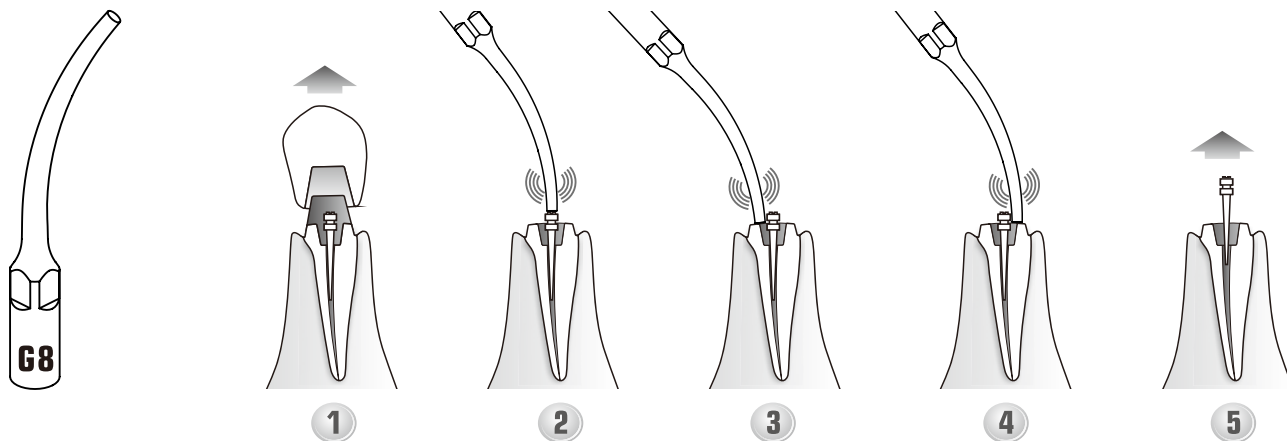

MODE: G
POWER

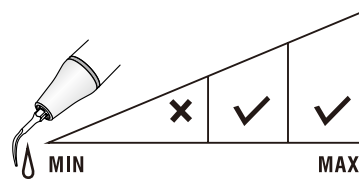
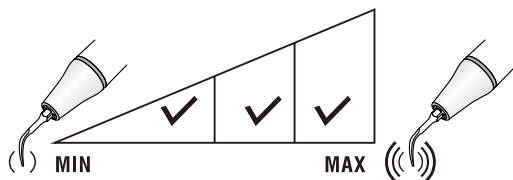

IRRIGATION

G9 (GD9)

Removal of supragingival calculus, interdental calculus and calculus at the neck of the teeth.

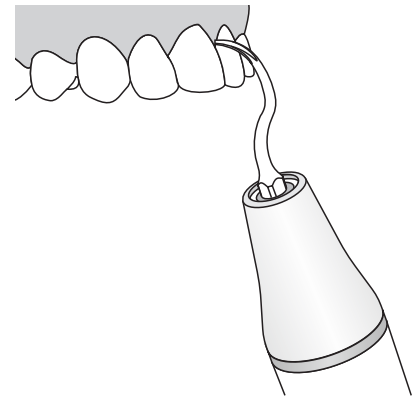
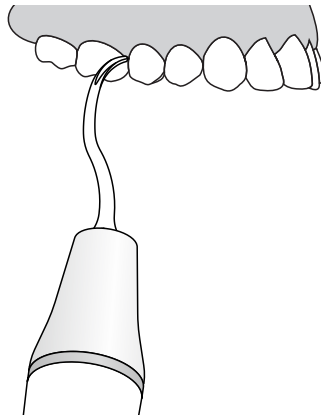

MODE: G
POWER

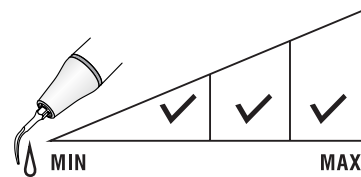
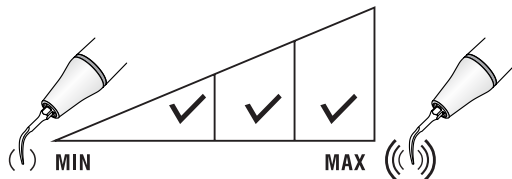

IRRIGATION

G10 (GD10)

Removal of supragingival deposits in all quadrants, including the interproximal and sulcus areas.

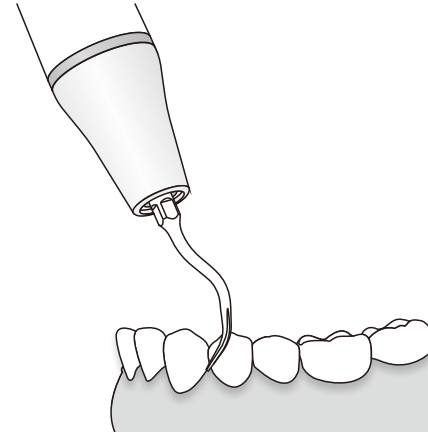
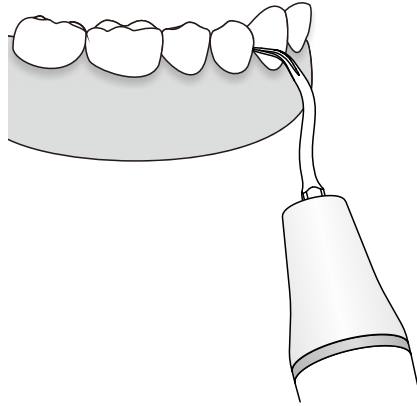

**MODE: G
POWER**

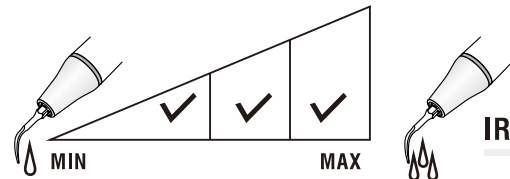
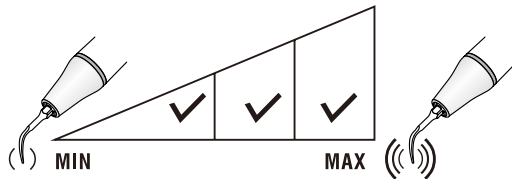

IRRIGATION

G11(GD11/GK11)

Diamond-coated(40μm) instrument for polishing the treatment surface of teeth in interproximal areas, without damaging the adjacent teeth during the orthodontics treatment.

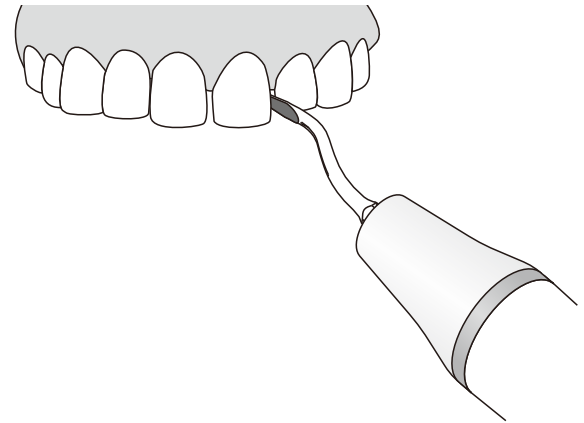
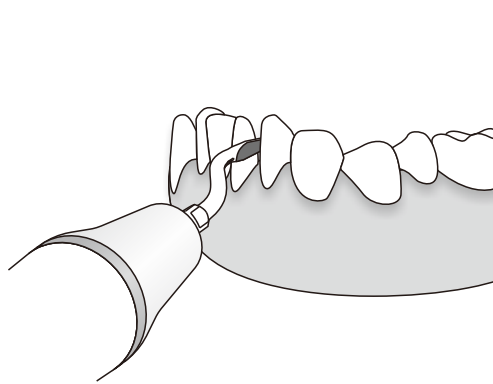

**MODE: G
POWER**

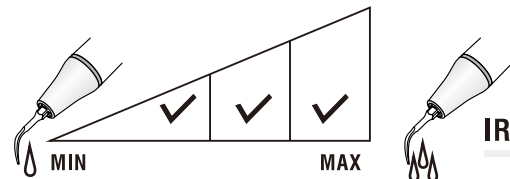
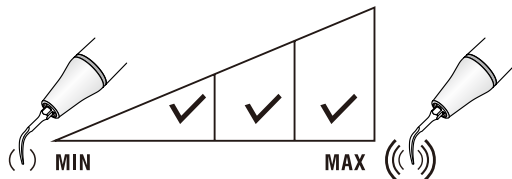

IRRIGATION

G12 (GD12)

Removal of large supragingival deposits on the lingual surfaces in all quadrants.

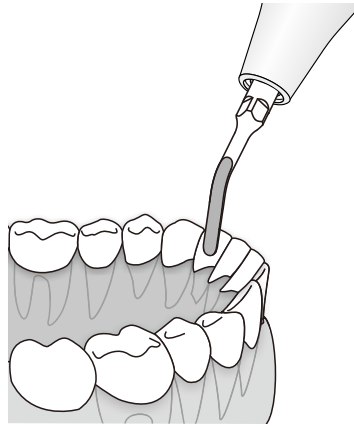
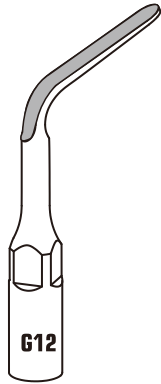

MODE: G
POWER

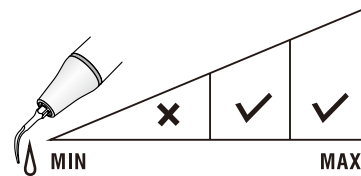
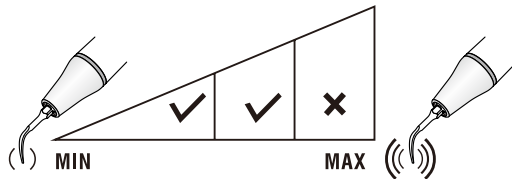

IRRIGATION

G20(GD20)

There are diamonds coated (120um grit) on the head of the tip for dentin abrading.

It's used for "supragingival shoulder" preparation after the completion of the preparation of the "subgingival shoulder" with bur.

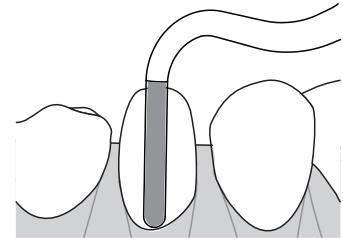
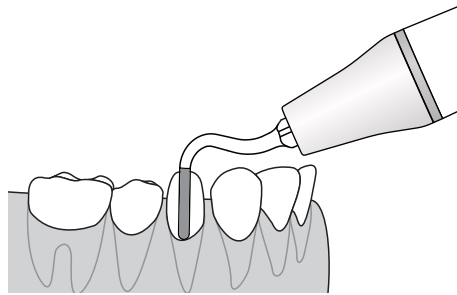

MODE: G
POWER

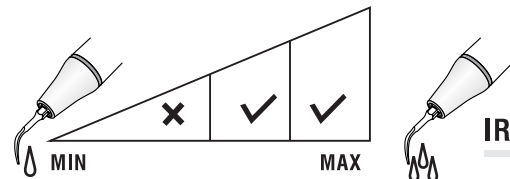
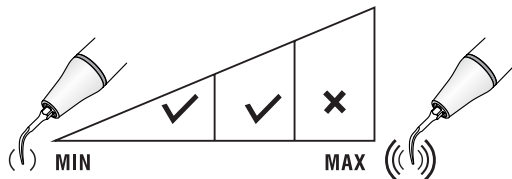

IRRIGATION

G21 (GD21)

There are diamonds coated (50um fine sand) on the head of the tip for dentin abrading, mainly used for polishing of prepared supragingival shoulder and subgingival shoulder.

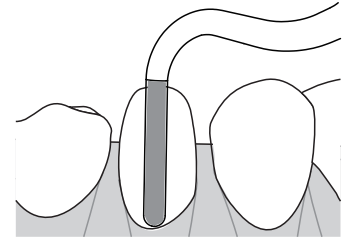
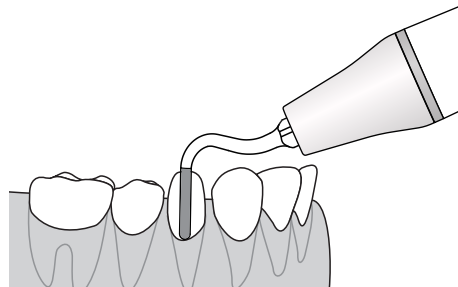

MODE: G
POWER

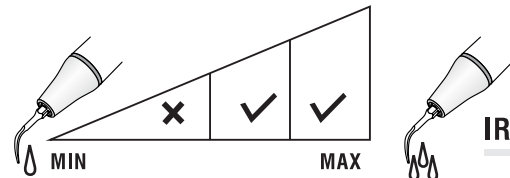
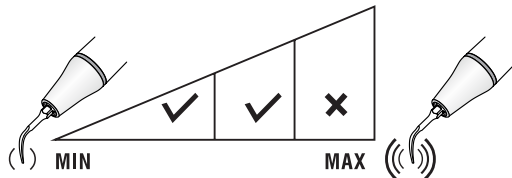

IRRIGATION

G30(GD30)

There are diamonds coated (90um) on the head of the tip, used for the preparation between pits and fissures.

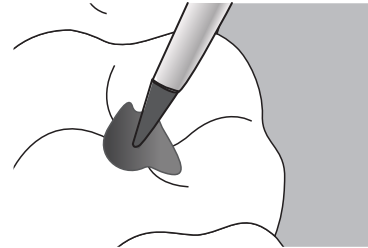
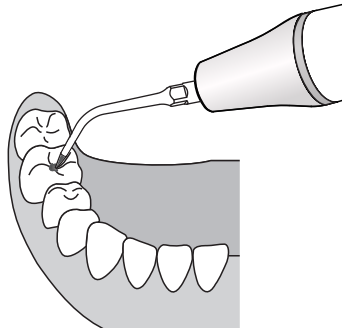
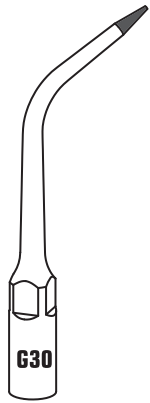

**MODE: G
POWER**

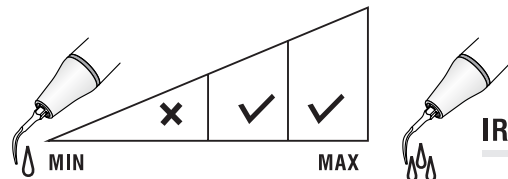
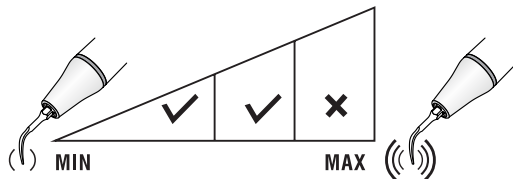

IRRIGATION

G31 (GD31)

There are diamonds coated (90um) on the head of the tip, used for the preparation of the mesial cavity.

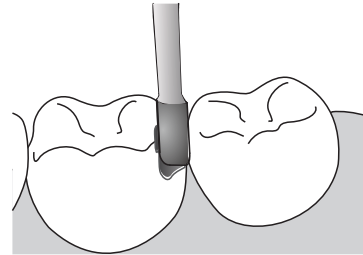
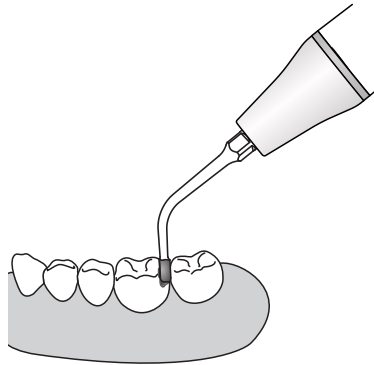

**MODE: G
POWER**

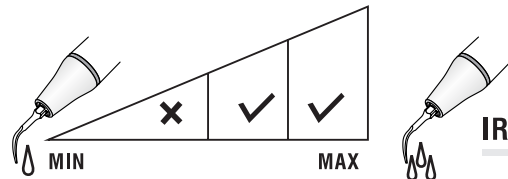
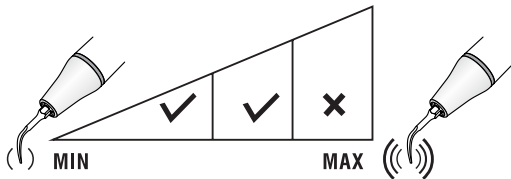

IRRIGATION

G32 (GD32)

There are diamonds coated (90um) on the head of the tip, used for the preparation of the distal cavity.

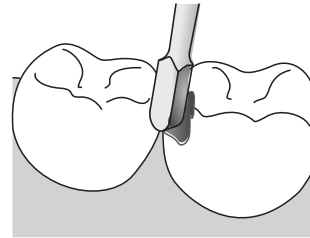
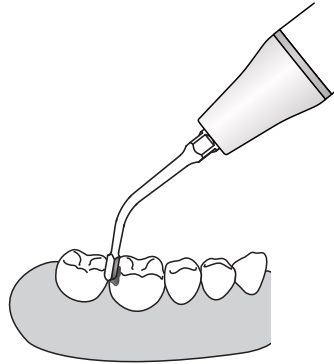
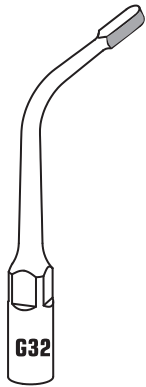

**MODE: G
POWER**

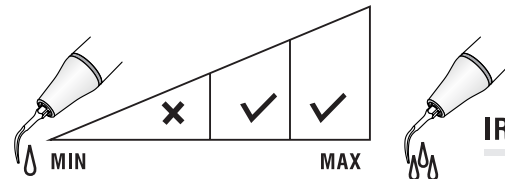
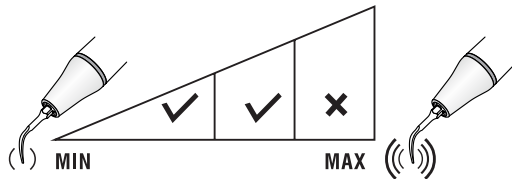

IRRIGATION

G33 (GD33)

There are diamonds coated (90um) on the head of the tip, used for the preparation of the tooth veneers.

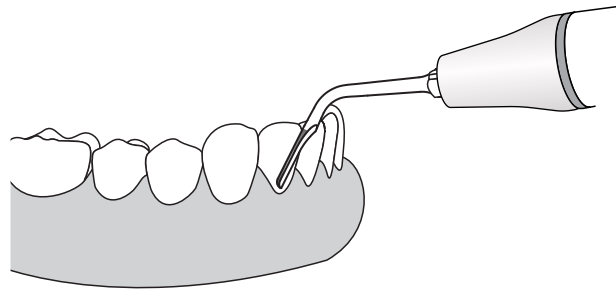
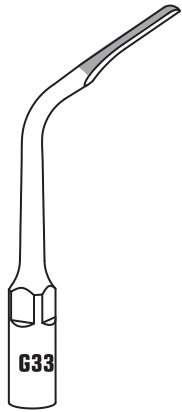

**MODE: G
POWER**

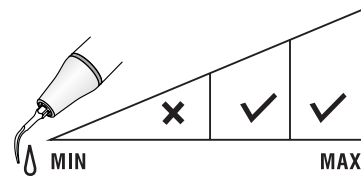
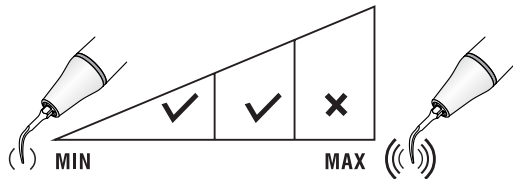

IRRIGATION

P1 (PD1/PS1)

Slim and sharp, recommended for cleaning and irrigating of subgingival deposits.

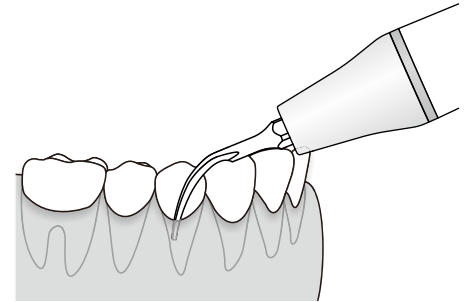
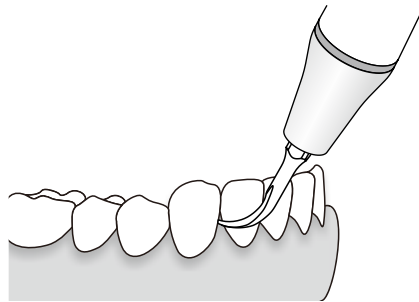
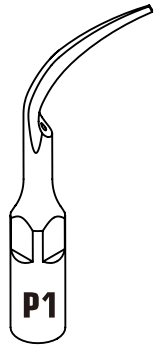

MODE: P
POWER

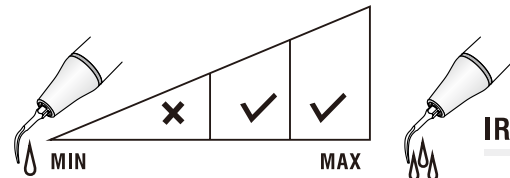
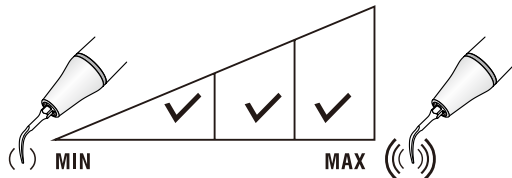

IRRIGATION

P2L(PD2L)

Left-angled, used to remove calculus from very narrow inter-root spaces and furcation.

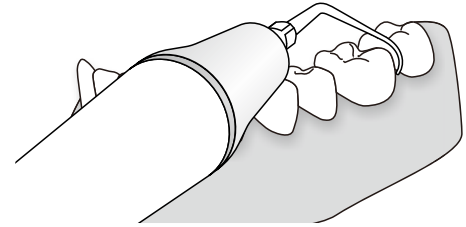
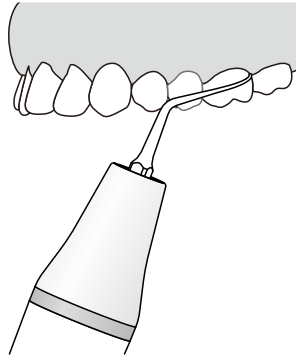
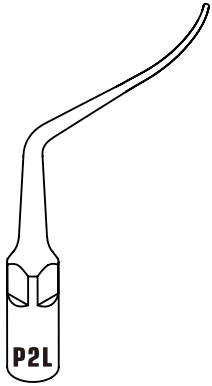

MODE: P
POWER

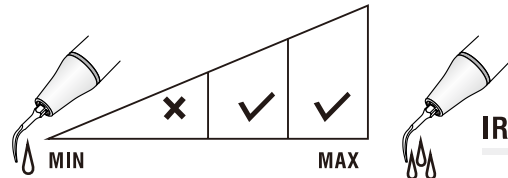
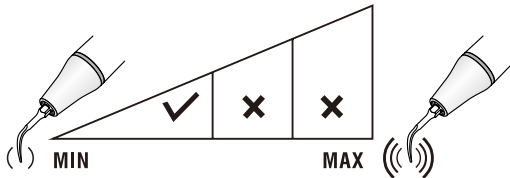

IRRIGATION

P2LD (PD2LD)

Left-angled, diamond-coated (40µm) instrument for root planing.

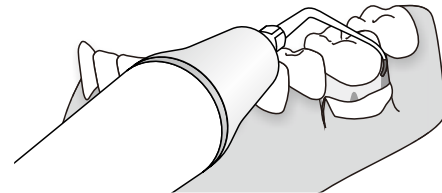
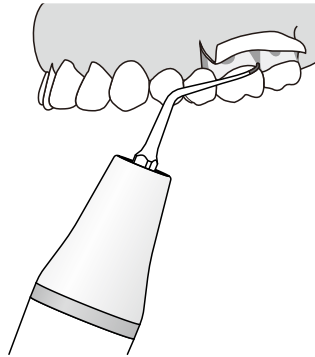
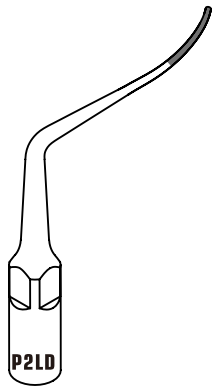

MODE: P
POWER

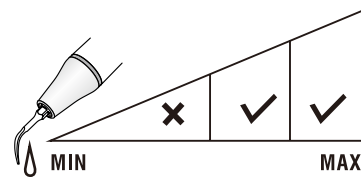
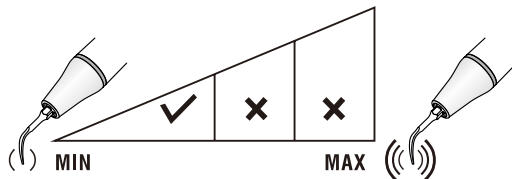

IRRIGATION

P2R (PD2R)

Right-angled, used to remove calculus from very narrow inter-root spaces and furcation.

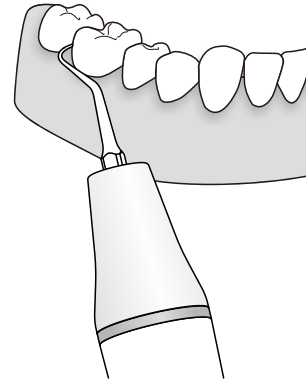
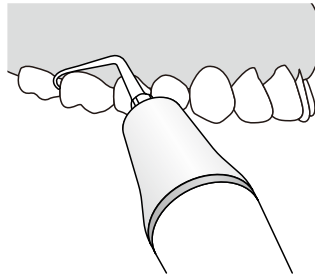
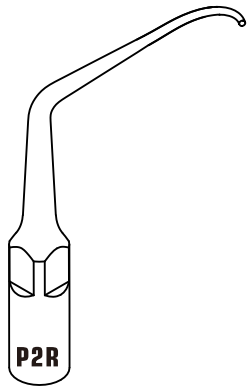

MODE: P
POWER

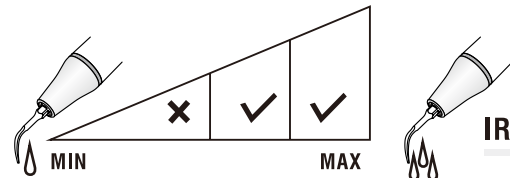
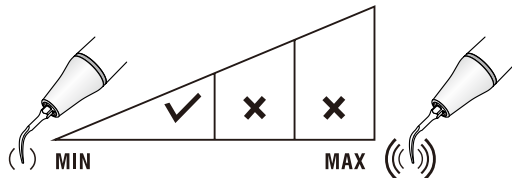

P2RD (PD2RD)

Right-angled, diamond-coated (40µm) instrument for root planing.

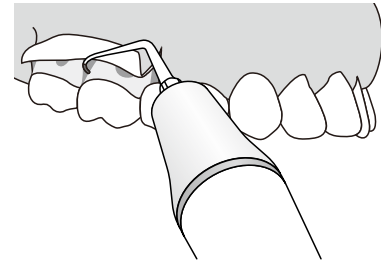
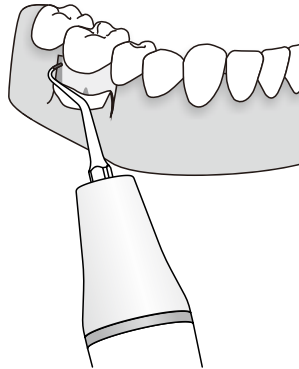
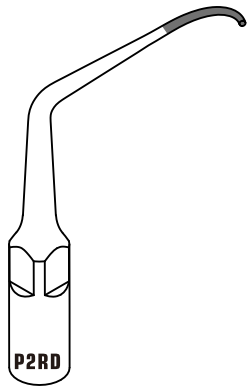

MODE: P
POWER

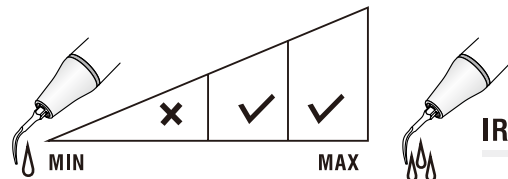
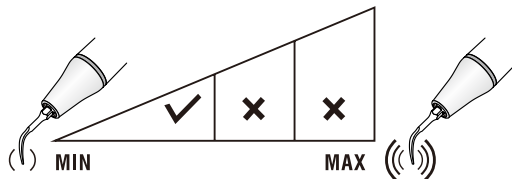

IRRIGATION

P3 (PD3/PS3)

Recommended for cleaning and irrigating of periodontal deep pockets.

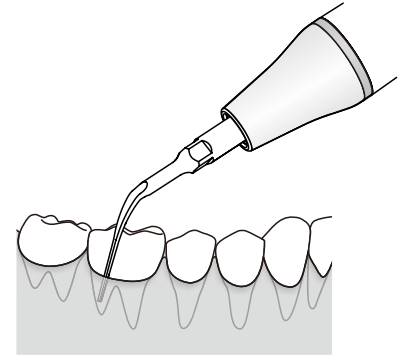
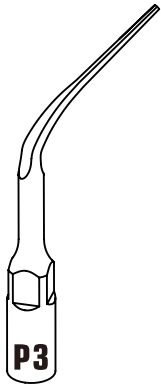

MODE: P
POWER

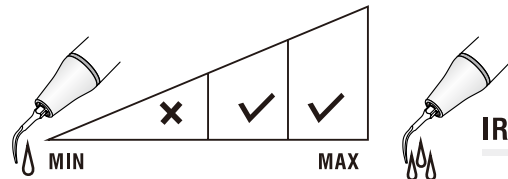
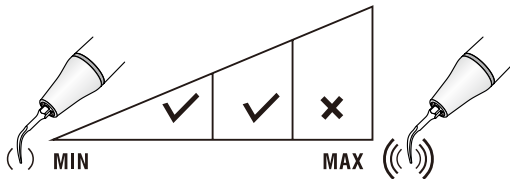

IRRIGATION

P3L (PD3L)

Left-angled, used for subgingival scaling.

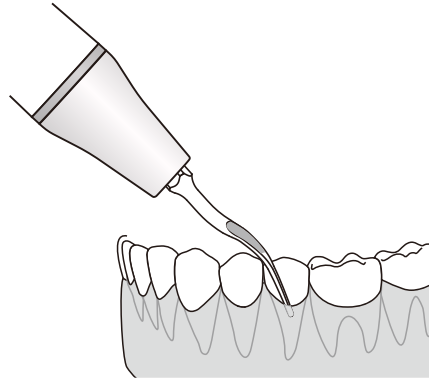

MODE: P
POWER

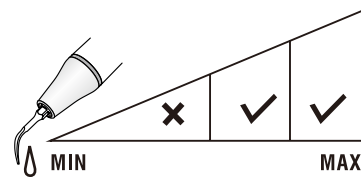
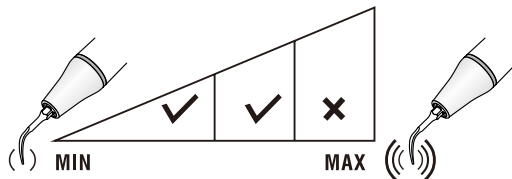

IRRIGATION

P3R (PD3R)

Right-angled, used for subgingival scaling.

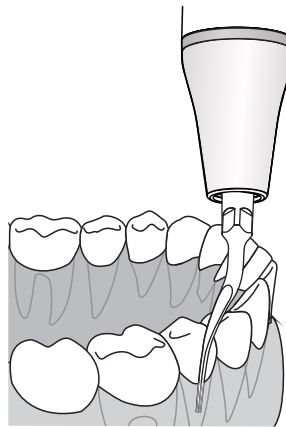

MODE: P
POWER

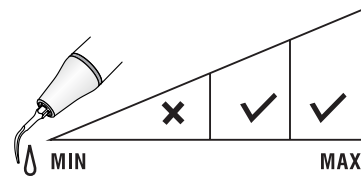
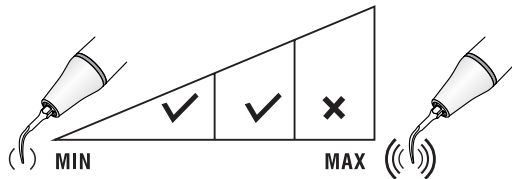

IRRIGATION

P3D(PD3D)

Diamond-coated(40μm) instrument for root planning after the periodontal flap surgery. It's also applied to edge planning of artificial crown and furcation expanding.

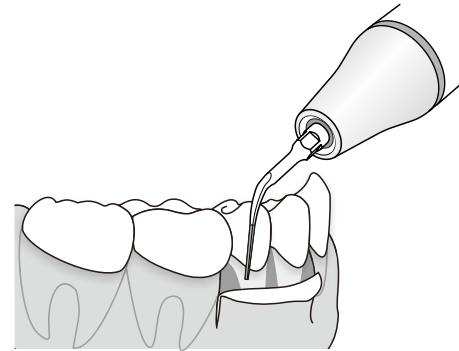
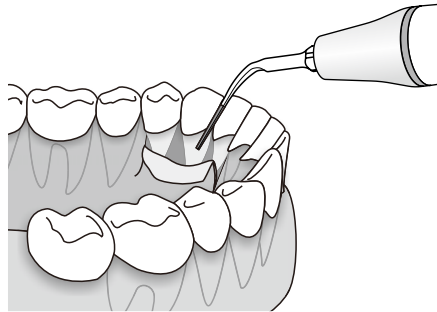
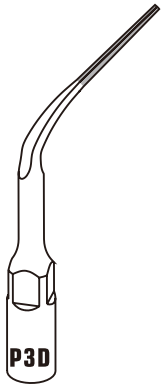

MODE: P
POWER

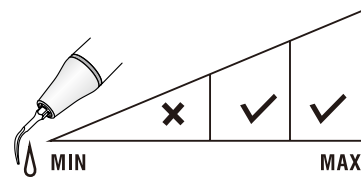
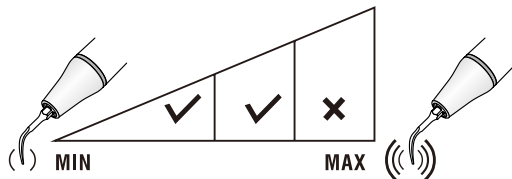

IRRIGATION

P4 (PD4/PS4)

Recommended for cleaning and irrigating of periodontal shallow pockets.

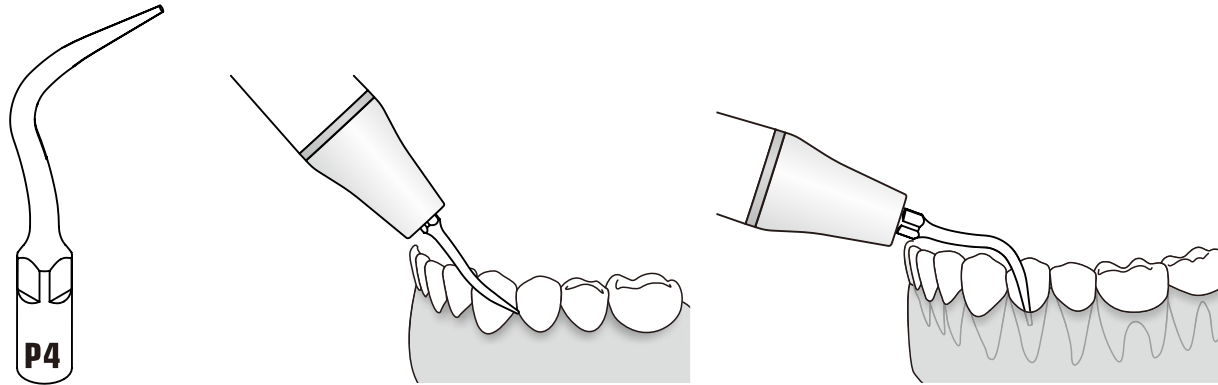

MODE: P
POWER

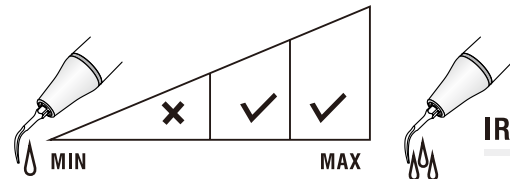
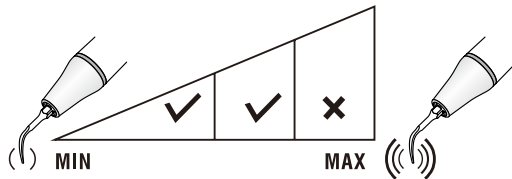

IRRIGATION

P5 (PD5)

For removal of the tartar in the adjacent of teeth and Gingival margin of the neck.

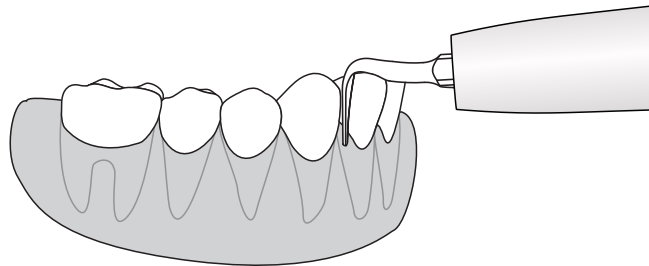

MODE: P
POWER

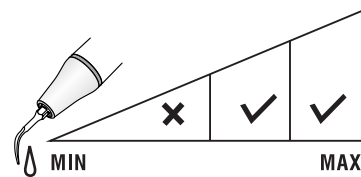
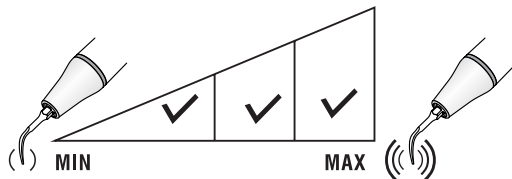

IRRIGATION



P6 (PD6)

Slim and sharp, recommended for cleaning and irrigating of periodontal deep pockets.

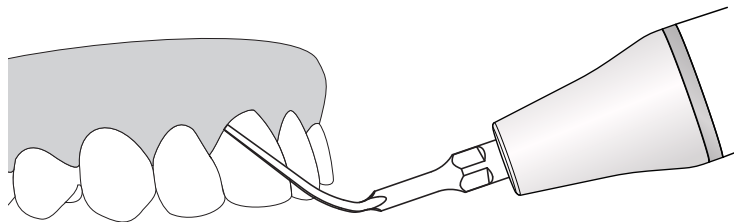
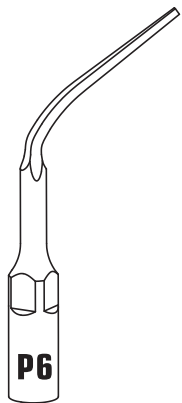

MODE: P
POWER

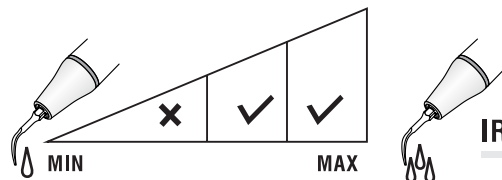
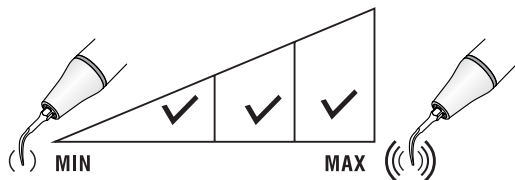

IRRIGATION

P7 (PD7)

Slim and sharp ,recommended for cleaning and irrigating of subgingival deposits.

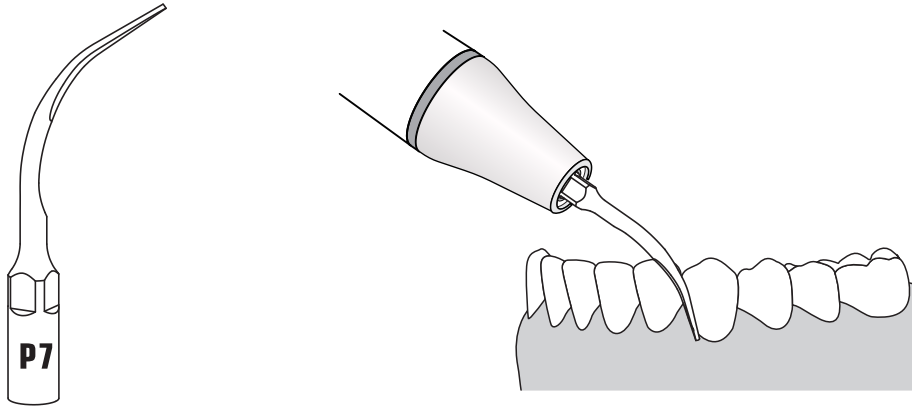

MODE: P
POWER

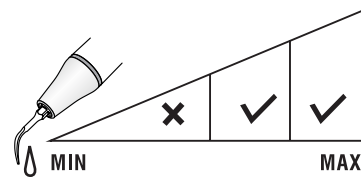
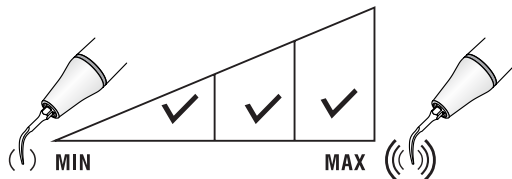

IRRIGATION

P10 (PD10)

For gentle scaling and removal of tartar in the periodontal pocket.

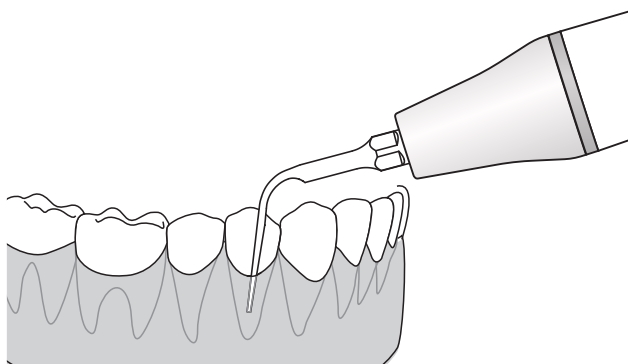
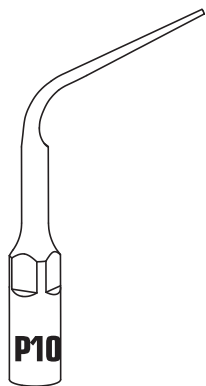

MODE: P
POWER

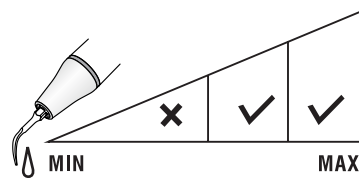
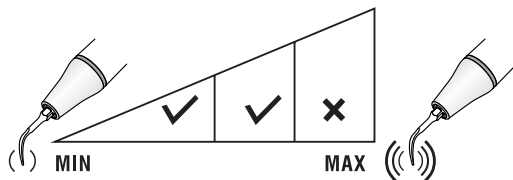

IRRIGATION

P11 (PD11)

For high efficient removal of the stubborn tartar in the subgingival.

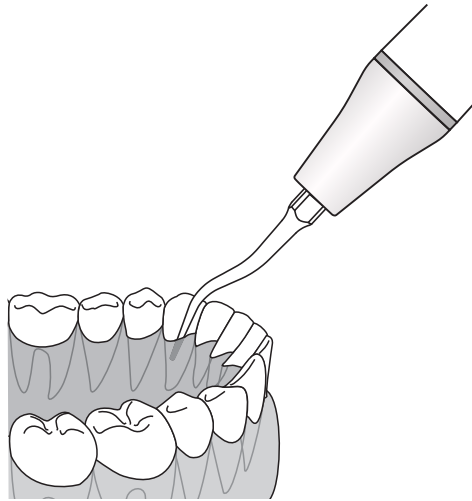

MODE: P
POWER

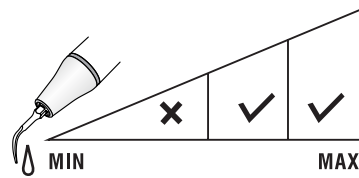
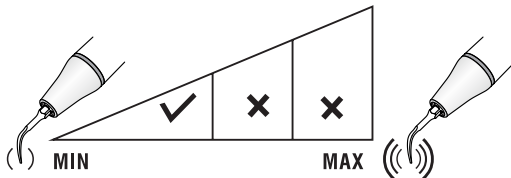

IRRIGATION

P12 (PD12)

With slim blade edge at the end of the tip, for high efficient removal of the stubborn tartar in posterior subgingival.

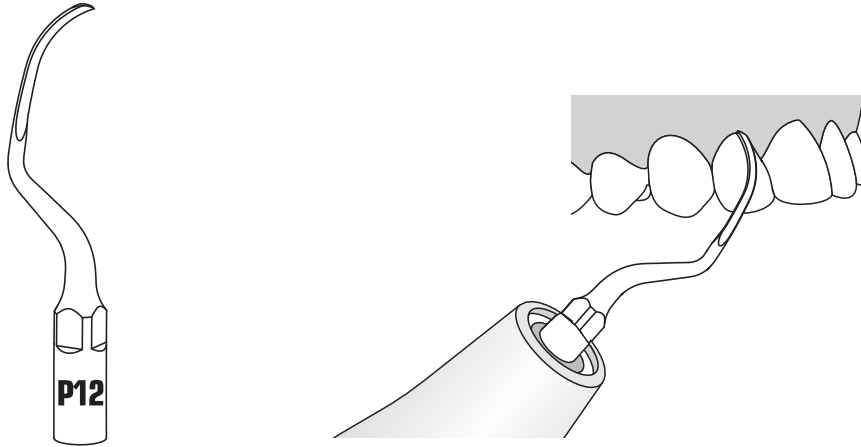

MODE: P
POWER

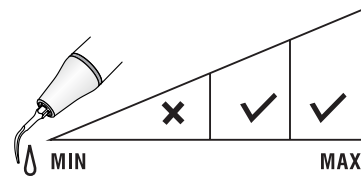
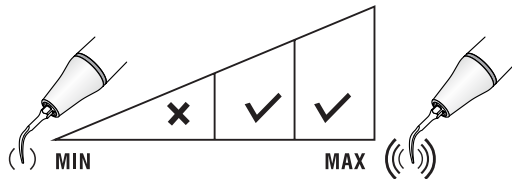

IRRIGATION

P14L(PD14L)

Left curved, with slim blade edge at the end of the tip, for high efficient removal of the stubborn tartar in posterior subgingival.

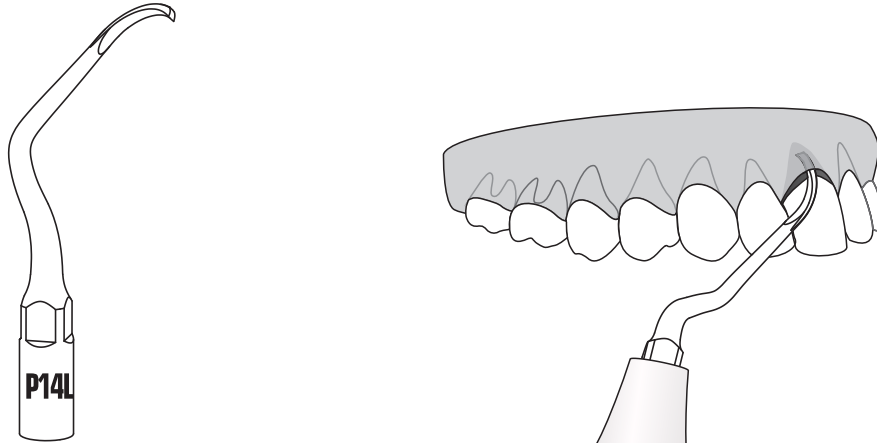

MODE: P
POWER

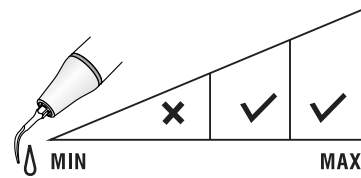
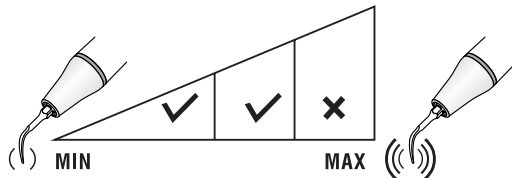

IRRIGATION

P14R (PD14R)

Right curved, with slim blade edge at the end of the tip, for high efficient removal of the stubborn tartar in posterior subgingival.

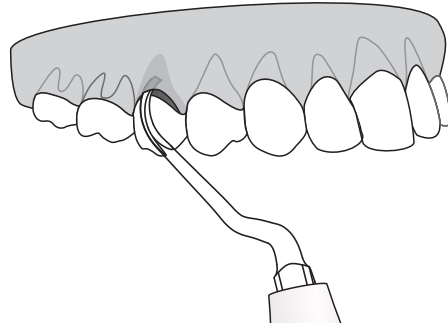
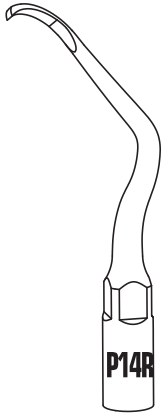

MODE: P
POWER

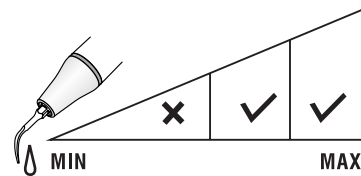
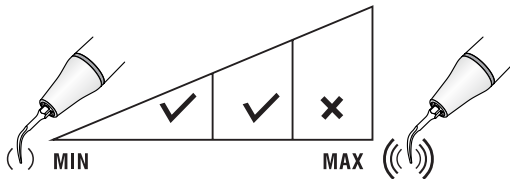

IRRIGATION

P18 (PD18)

For probing the deep periodontal pocket tartar, and subgingival rinse after scaling.

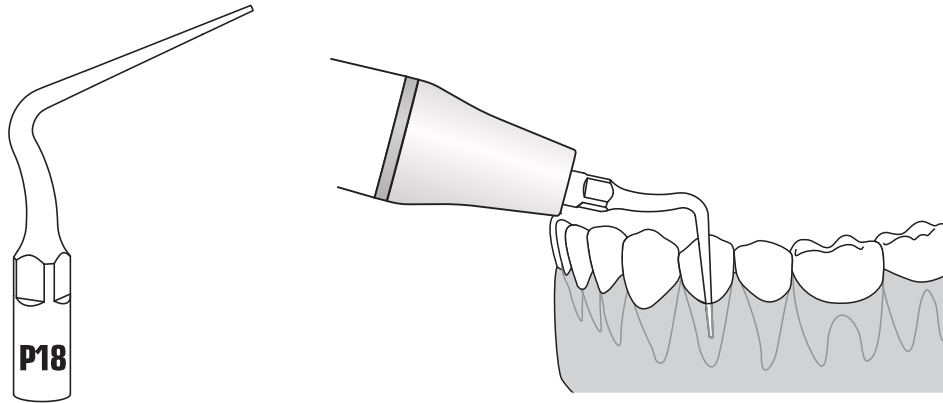

MODE: P
POWER

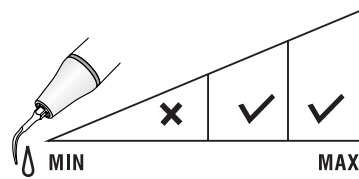
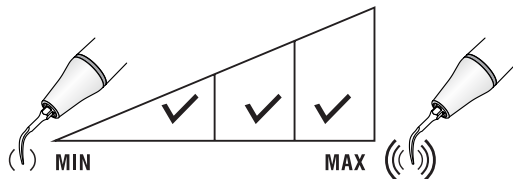

IRRIGATION

P20 (PD20)

For removal of the tartar in the adjacent of teeth, gingival margin of the neck and the tartar within 3mm in the subgingival pocket.

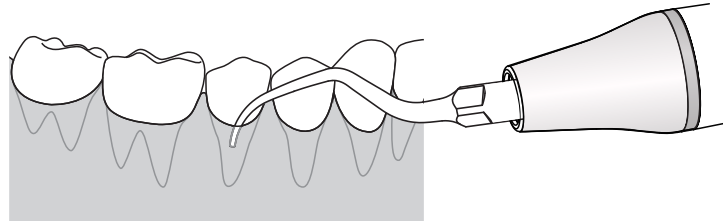

MODE: P
POWER

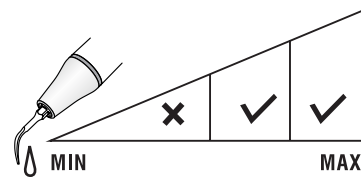
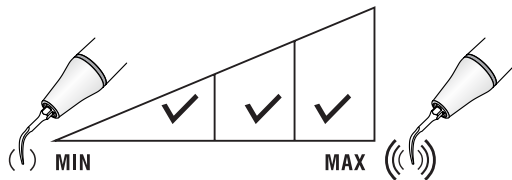

IRRIGATION

P20L (PD20L)

Left curved, for high efficient removal of the stubborn tartar in posterior subgingival.

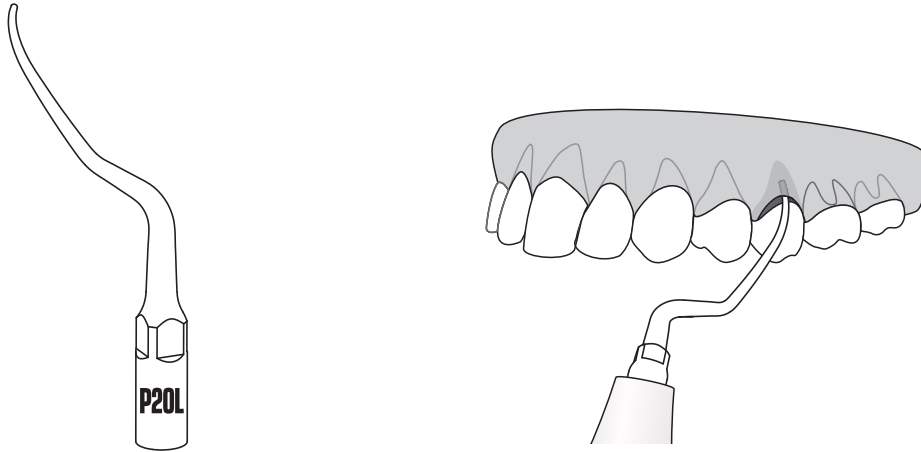

MODE: P
POWER

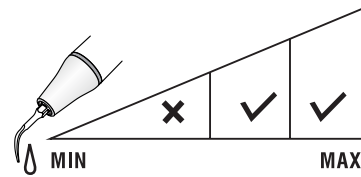
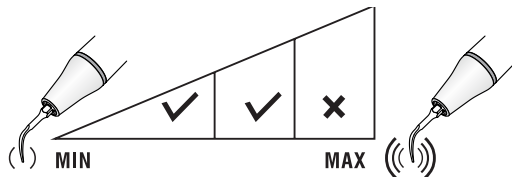

IRRIGATION

P20R (PD20R)

Right curved, for high efficient removal of the stubborn tartar in posterior subgingival.

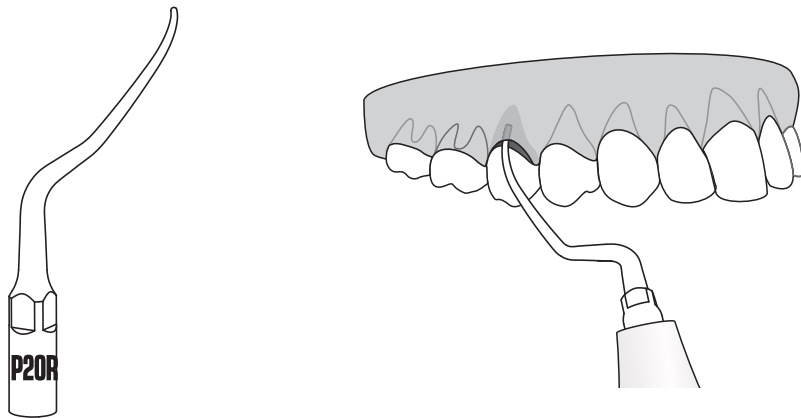

MODE: P
POWER

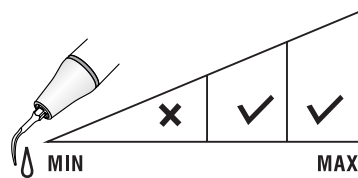
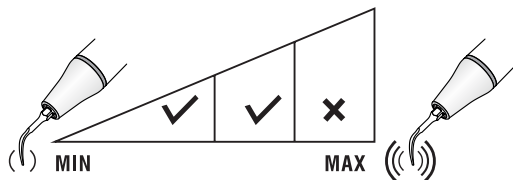

IRRIGATION

P21L(PD21L)

Left curved, for the scaling of root bifurcation and root surface of adjacent of posterior teeth sector.

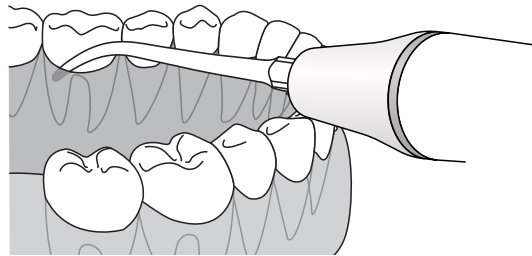

MODE: P
POWER

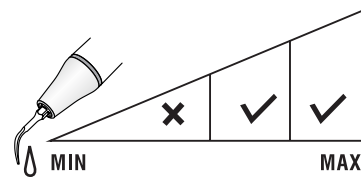
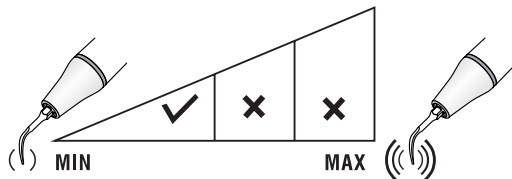

IRRIGATION

P21R (PD21R)

Right curved, for the scaling of root bifurcation and root surface of adjacent of posterior teeth sector.

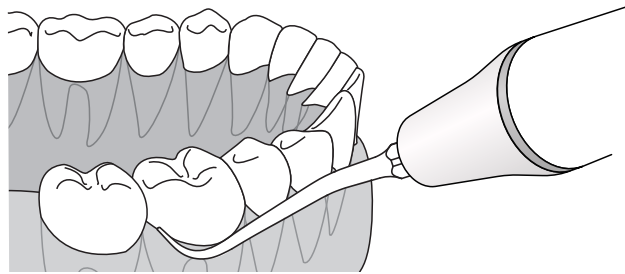

MODE: P
POWER

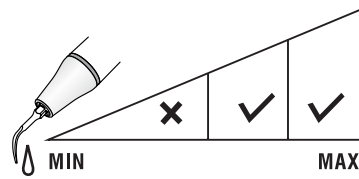
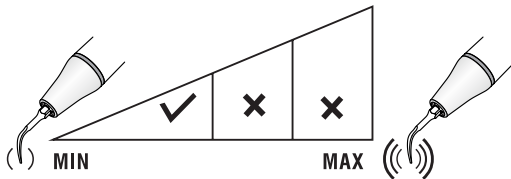

IRRIGATION

P22L(PD22L)

Left curved, the 12mm straight part can assure the complete removal of subgingival tartar and stains.

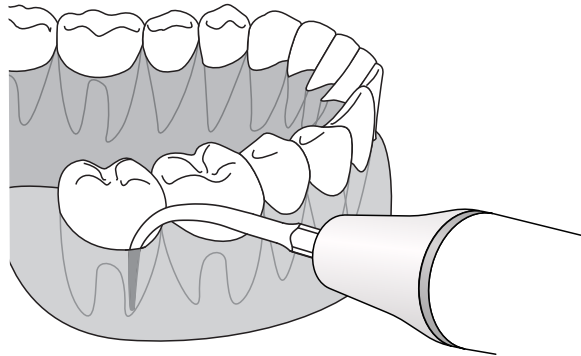
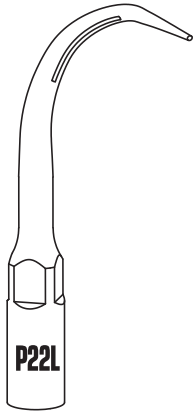

MODE: P
POWER

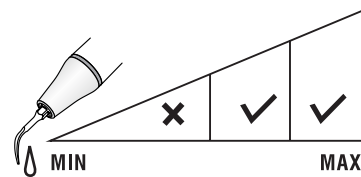
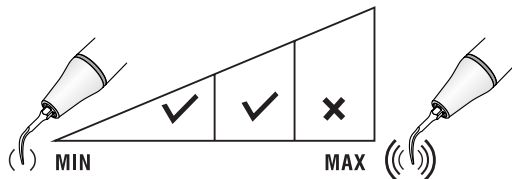

IRRIGATION

P22R (PD22R)

Right curved, the 12mm straight part can assure the complete removal of subgingival tartar and stains.

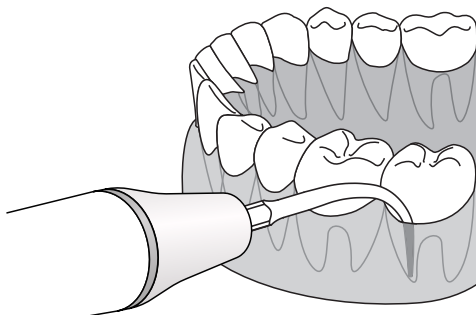
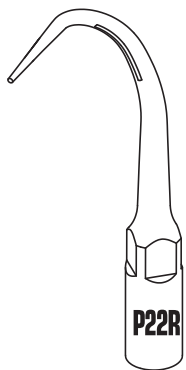

MODE: P
POWER

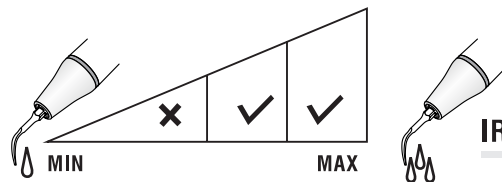
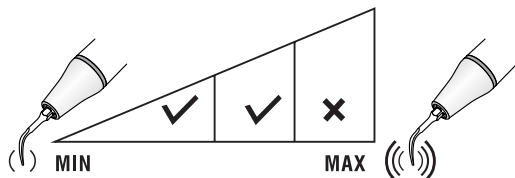

IRRIGATION

E1(ED1/ES1)

120° holder, used to hold the file diameter $\Phi 0.7\text{mm}$ or $\Phi 0.8\text{mm}$.

Recommended for the cleaning and irrigating of the root canal, usually used for the anterior teeth.

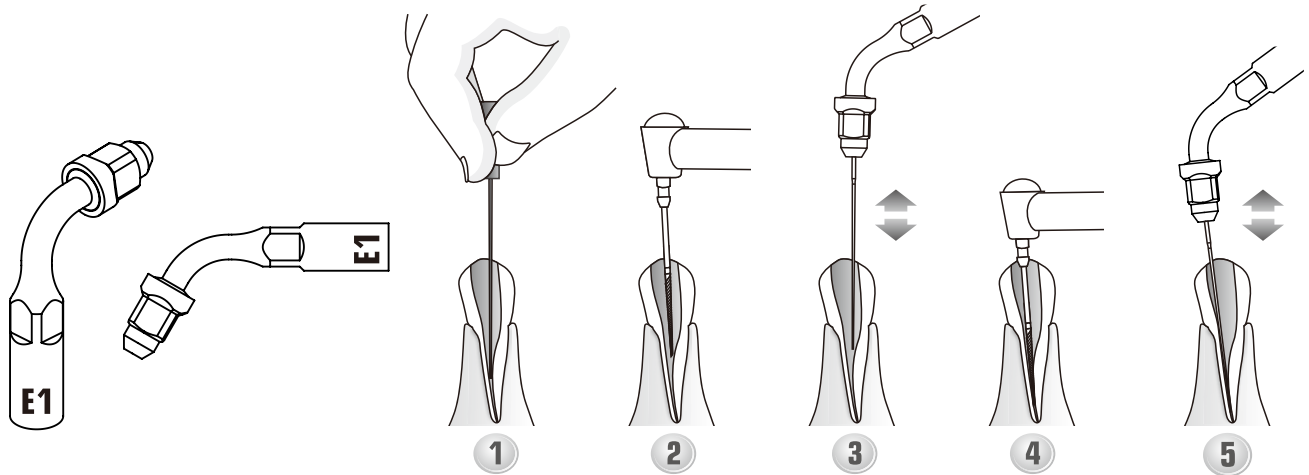

Use only the provided flat wrench to tighten the file holders on the handpiece, as well as for gently tightening the files or instruments in the holder. Do not over tighten.

Do not tighten the holder nut when no file or instrument is installed as this may damage it.

Do not mix-install the holder with $\Phi 0.7\text{mm}$ and $\Phi 0.8\text{mm}$ file, the $\Phi 0.8\text{mm}$ file will not be able to be installed after a $\Phi 0.7\text{mm}$ file installed on the holder.

MODE: E

POWER

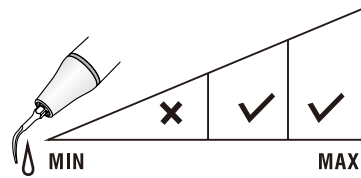
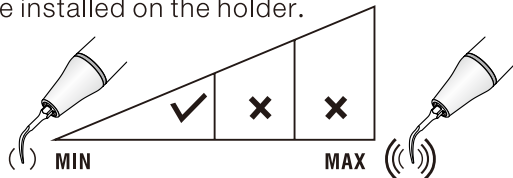

IRRIGATION

E2(ED2/ES2)

95° holder, used to hold the file diameter $\Phi 0.7\text{mm}$ or $\Phi 0.8\text{mm}$.

Recommended for cleaning and irrigation of the root canal, usually used for the molar teeth.

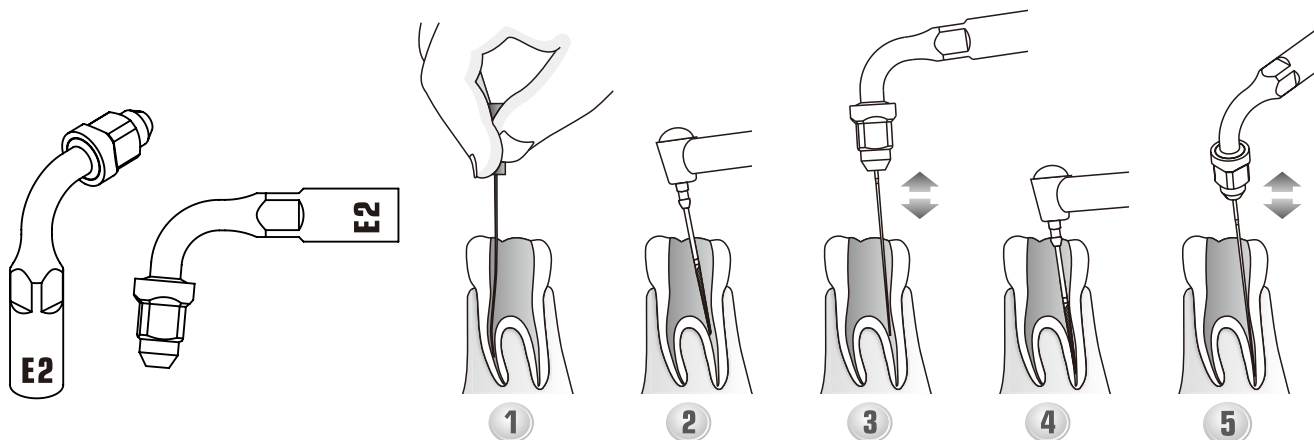

Use only the provided flat wrench to tighten the file holders on the handpiece, as well as for gently tightening the files or instruments in the holder. Do not over tighten.

Do not tighten the holder nut when no file or instrument is installed as this may damage it.

Do not mix-install the holder with $\Phi 0.7\text{mm}$ and $\Phi 0.8\text{mm}$ file, the $\Phi 0.8\text{mm}$ file will not be able to be installed after a $\Phi 0.7\text{mm}$ file installed on the holder.

MODE: E

POWER

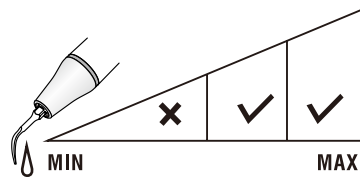
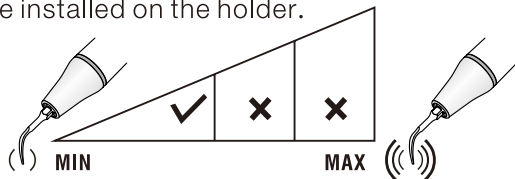

IRRIGATION

E3 (ED3/ES3)

Recommended for melting gutta-percha.

Immerse the instrument in eugenol before inserting it in the canal.

Slightly press the instrument against the cone of gutta-percha and activate the scaler to condense until the canal is filled.

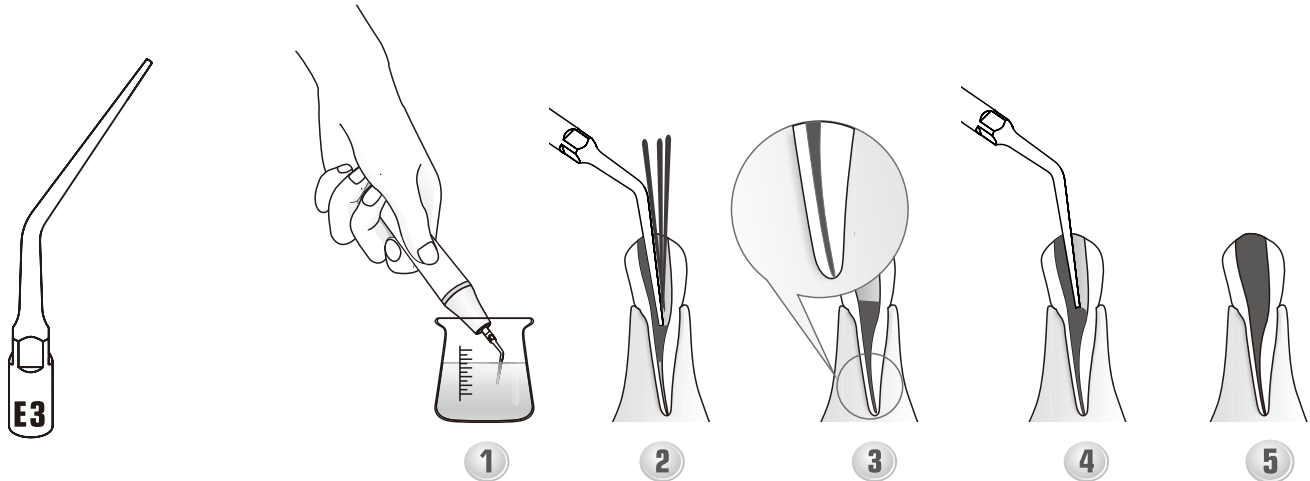

MODE: E
POWER

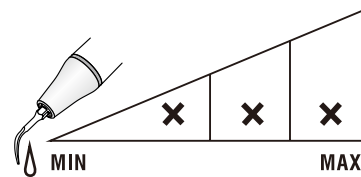
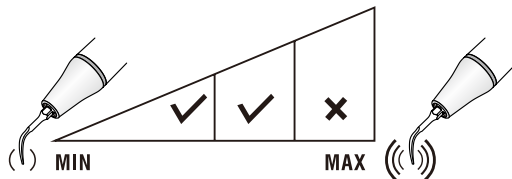

IRRIGATION

E3D(ED3D/ES3D)

Diamond-coated(40 μ m) instrument for enlarging the root canal and access to files broken in the root canal.

Don't touch the broken file when enlarging the root canal in case putting it deeper in the canal.

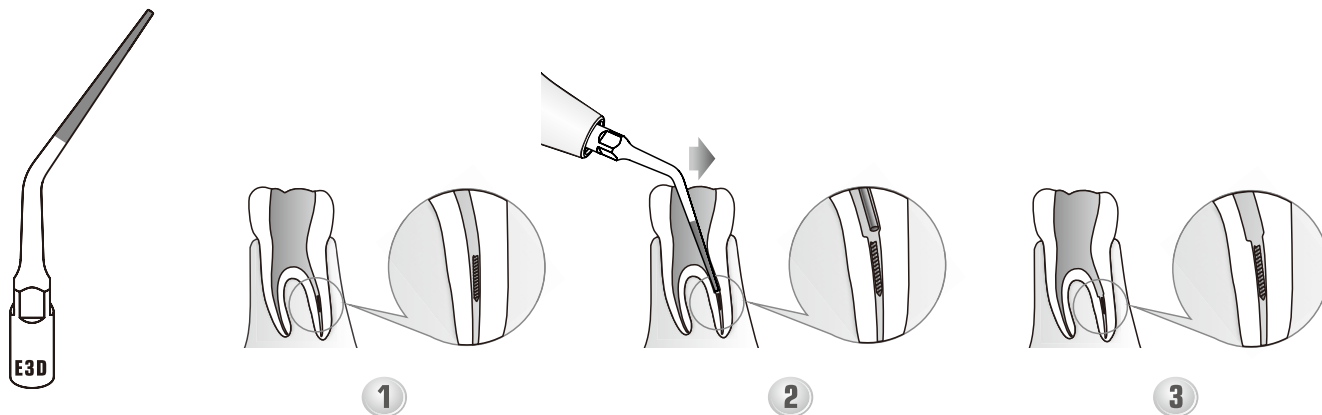

MODE: E
POWER

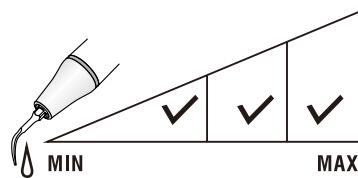
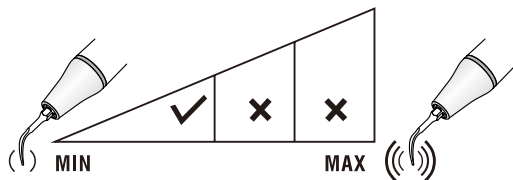

IRRIGATION

E4(ED4/ES4)

Used to remove the root filling obstructions during the root canal retreatment. The length of tip slender part is (22mm).

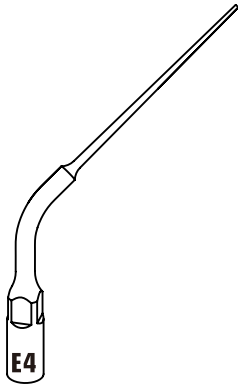

1



2

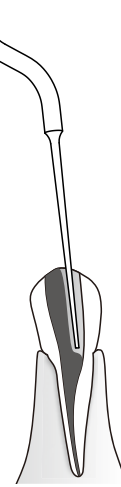

3

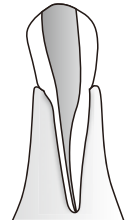

MODE: E
POWER

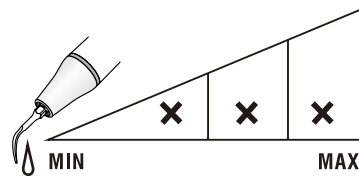
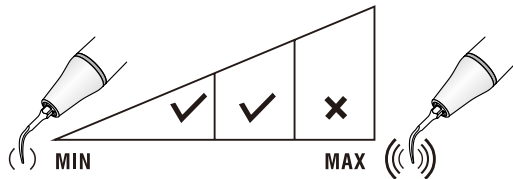

IRRIGATION

E4D(ED4D/ES4D)

Diamond-coated(40 μ m) instrument for removing the calcification and bad filling material in the root canal during the root canal retreatment. The length of the diamond-coated on tip is (15mm).

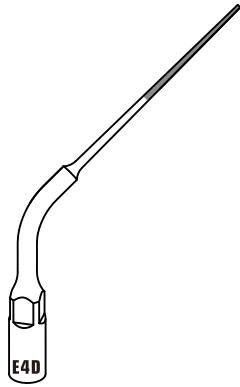

1

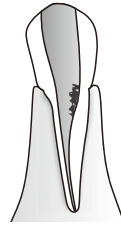

2

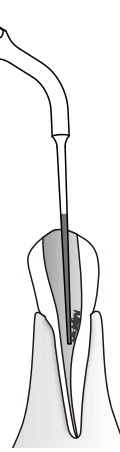

3

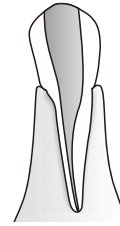

MODE: E
POWER

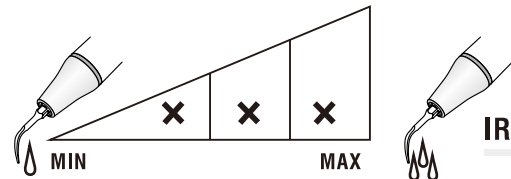
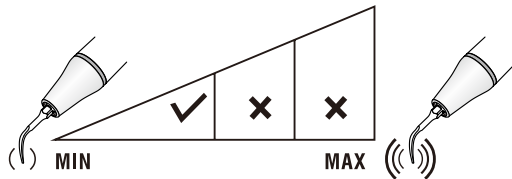

IRRIGATION

E5 (ED5/ES5)

Used to remove the root filling obstructions during the root canal retreatment. The length of tip slender part is (16mm).

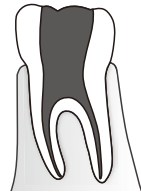
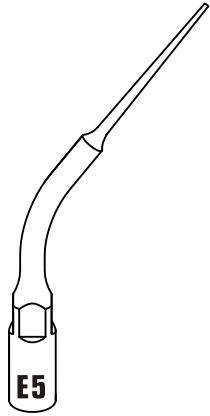

1

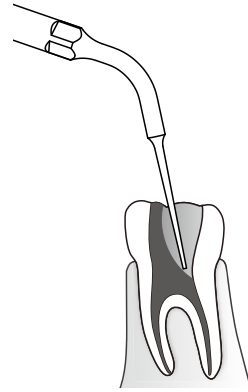

2

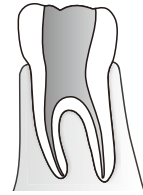

3

MODE: E
POWER

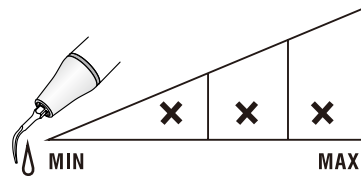
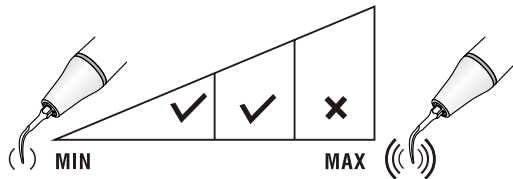

IRRIGATION

E5D(ED5D/ES5D)

Diamond-coated(40 μ m) instrument for removing the calcification and bad filling material in the root canal during the root canal retreatment. The length of the diamond-coated on tip is (10mm).

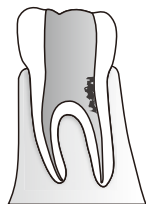
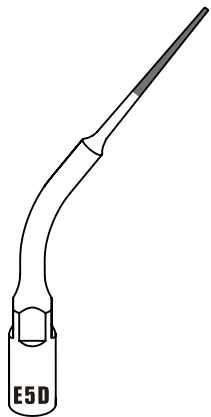

1

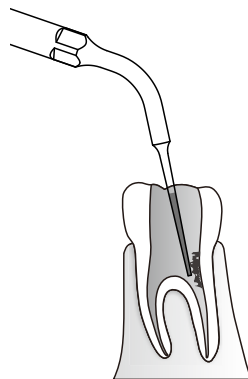

2

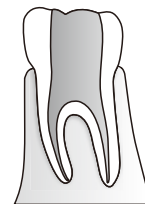

3

MODE: E
POWER

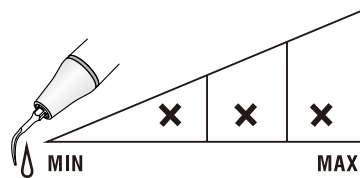
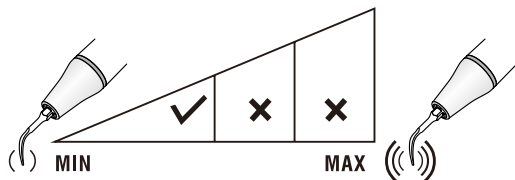

IRRIGATION

P4D (PD4D/PS4D)

Diamond-coated (40µm) instrument for root canal orientation. It can also be applied to remove the calcifications located at the 1/3 part of root canal.

Don't press too much during the treatment to avoid hurting the root canal.

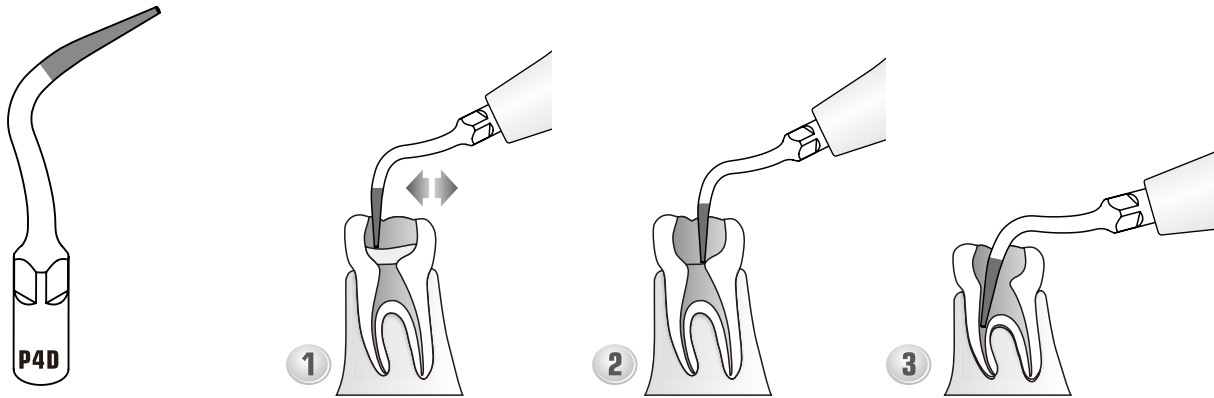

MODE: E
POWER

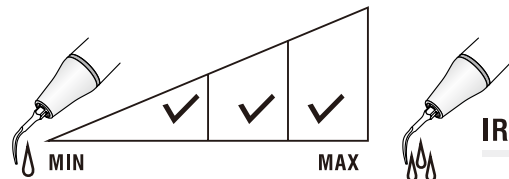
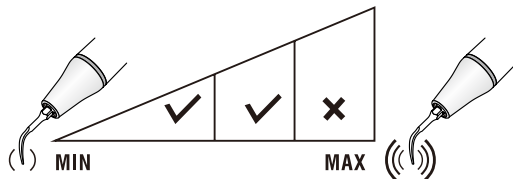

IRRIGATION

E6 (ED6)

Thin and flexible, used for removing foreign body in deep canal.

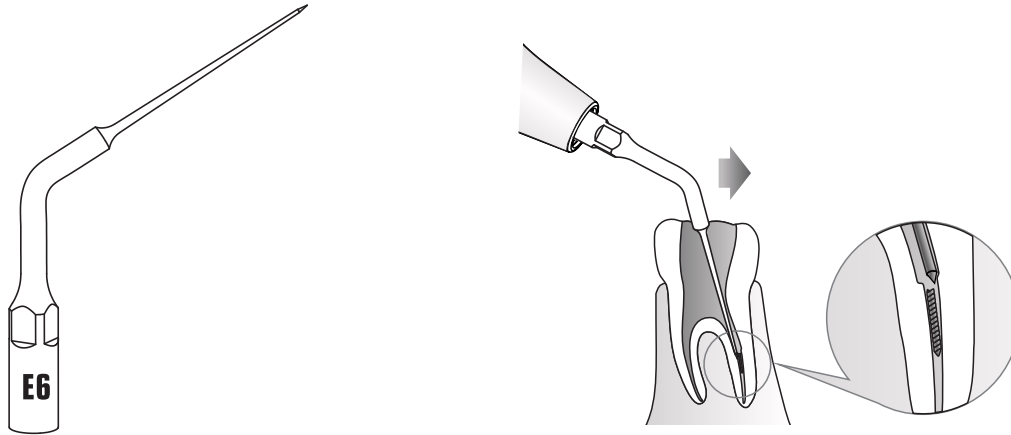

MODE: E
POWER

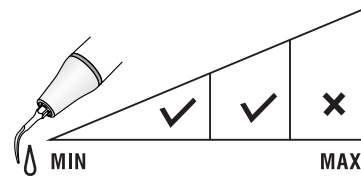
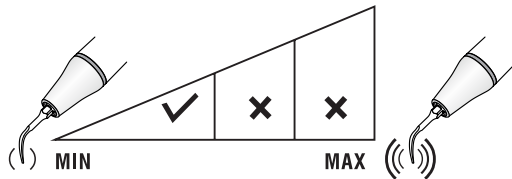

IRRIGATION

E7 (ED7)

Thin and flexible, used for removing foreign body in 1/3 canal.

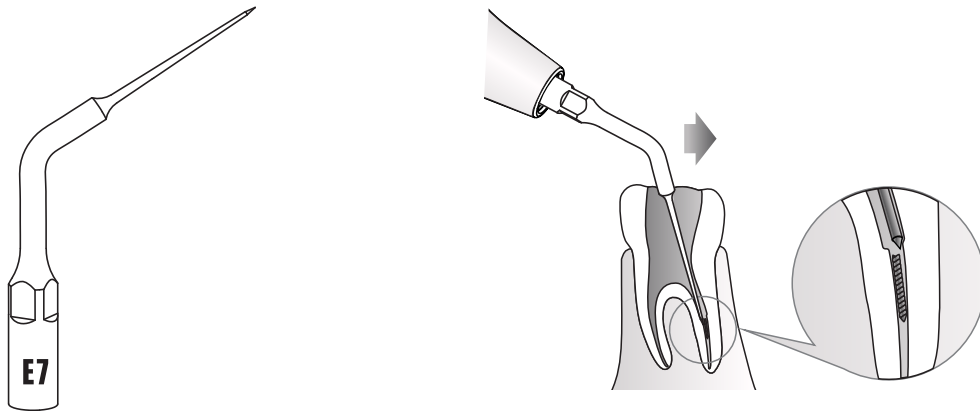

MODE: E
POWER

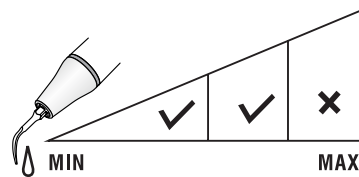
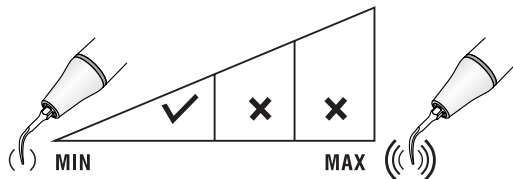

IRRIGATION

E8(ED8/ES8/EK8)

Recommended for holding different types of dental bur to realize a variety of treatment on teeth.
Usually used for the anterior teeth.
Special burs used for dental implant is applicable.

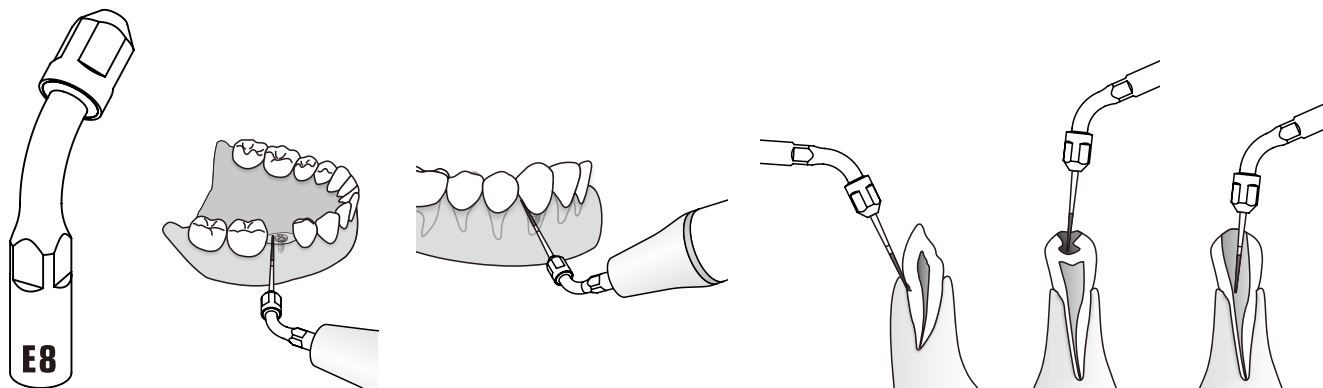

MODE: E
POWER

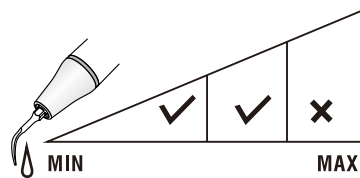
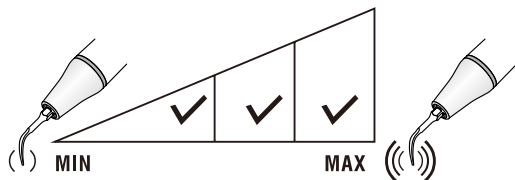

IRRIGATION

E9(ED9)

Recommended for holding different types of dental bur to realize a variety of treatment on teeth.
Usually used for the molar teeth.
Special burs used for dental implant is applicable.

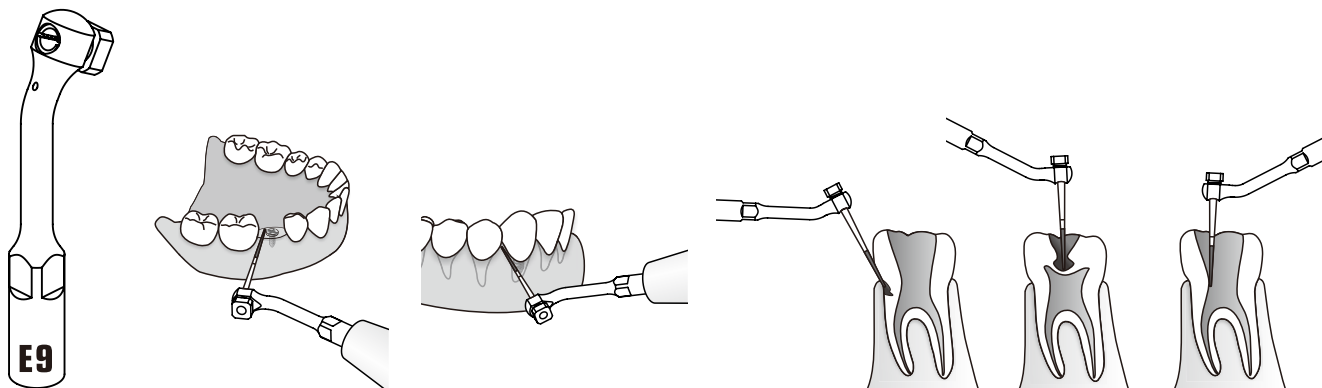

MODE: E
POWER

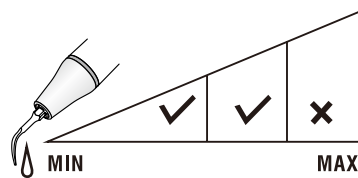
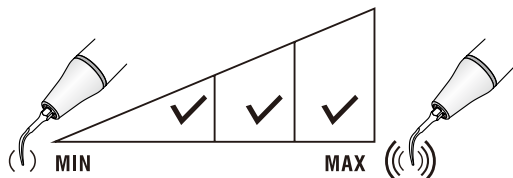

IRRIGATION

E10(ED10/ES10)

Used to polish the root canal in the retrograde preparation of root canals. The length of tip slender part is (4.5mm).

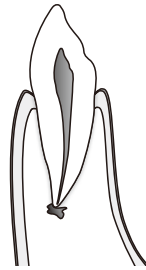
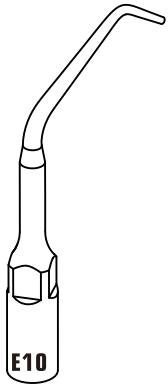

1

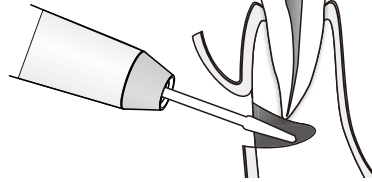

2

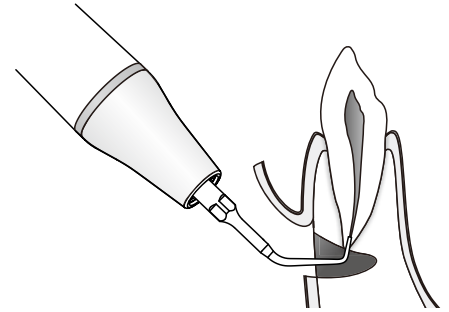

3

MODE: E
POWER

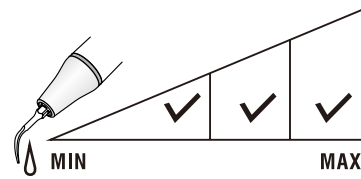
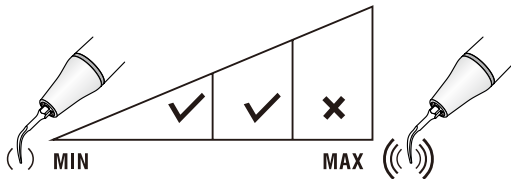

IRRIGATION

E10D(ED10D/ES10D)

Diamond-coated(40 μ m) instrument for high efficiency root planning in the retrograde preparation of root canals. The length of the diamond-coated on tip is (3.3mm).

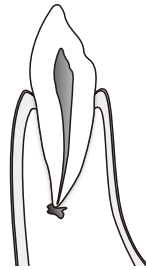
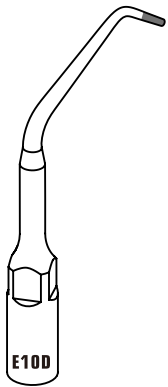

1

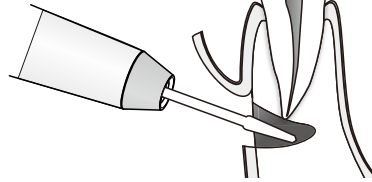

2

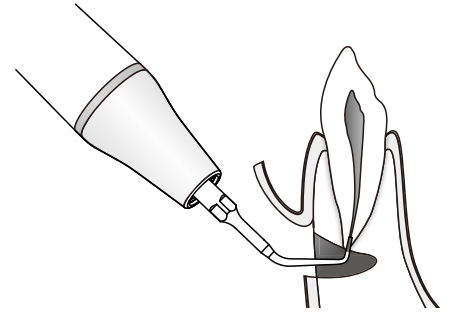

3

MODE: E
POWER

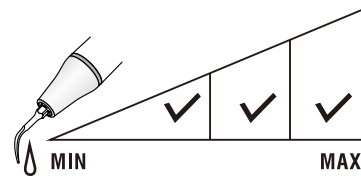
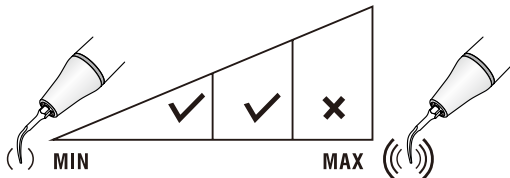

IRRIGATION

E11(ED11/ES11)

Used to polish the root canal in the retrograde preparation of root canals. The length of tip slender part is (3.5mm).

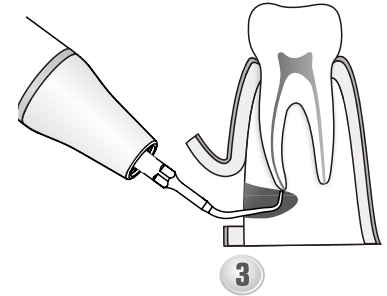
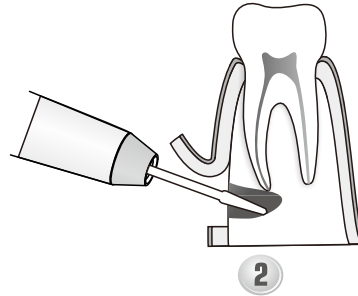
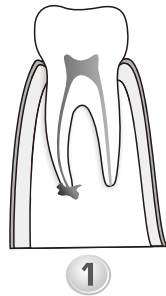
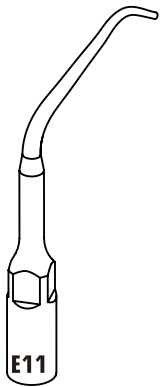

MODE: E
POWER

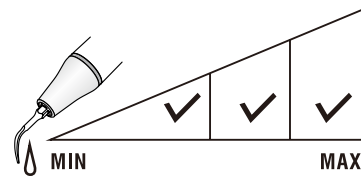
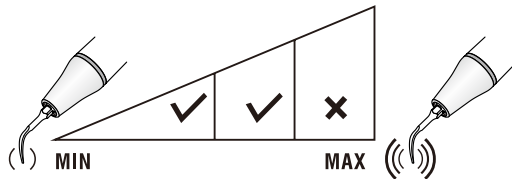

IRRIGATION



E11D(ED11D/ES11D)

Diamond-coated(40µm) instrument for high efficiency root planning in the retrograde preparation of root canals. The length of the diamond-coated on tip is (2.2mm).

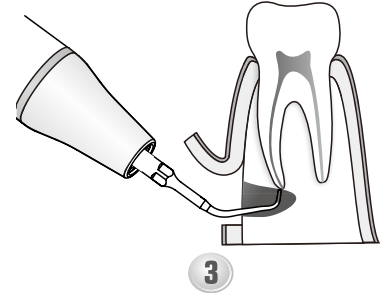
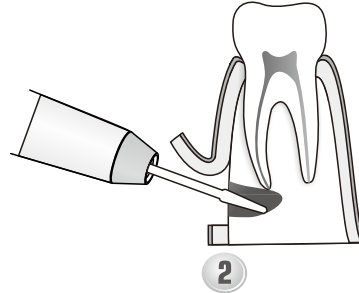
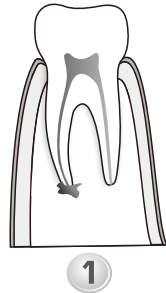
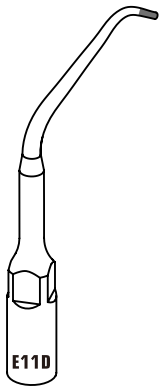

**MODE: E
POWER**

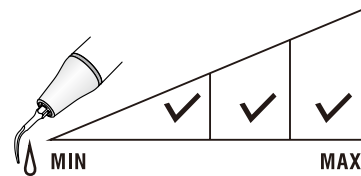
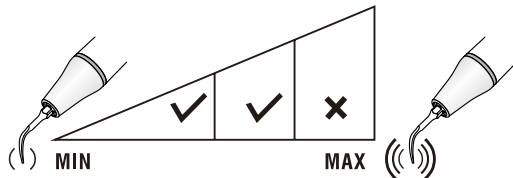

IRRIGATION

E12D(ED12D)

Diamond-coated(90um),used for removing the calcification and bad filling material of pulp cavity,exposing the root canal orifice.

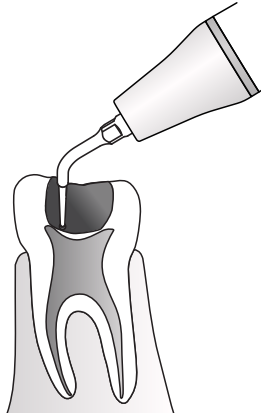
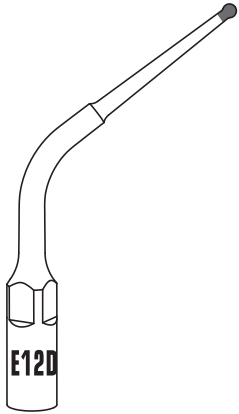

MODE: E
POWER

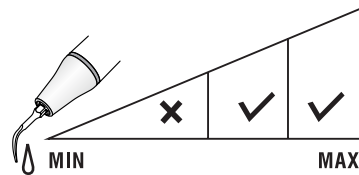
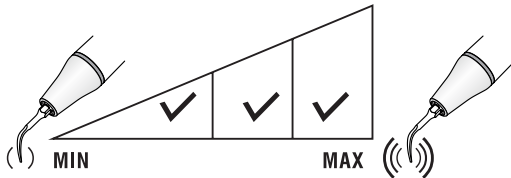

IRRIGATION

E14(ED14/ES14)

Instrument for the removal of broken files inside the root canal. The length of tip slender part is (22mm).

If possible place the patient's head in a position where the root canal is horizontal with a downward inclination. Rotate the tip of the instrument counterclockwise around the broken part until it is picked out from the root canal.

To avoid push the broken file deeper into the root canal, do not use pressure to the instrument in the axial direction.

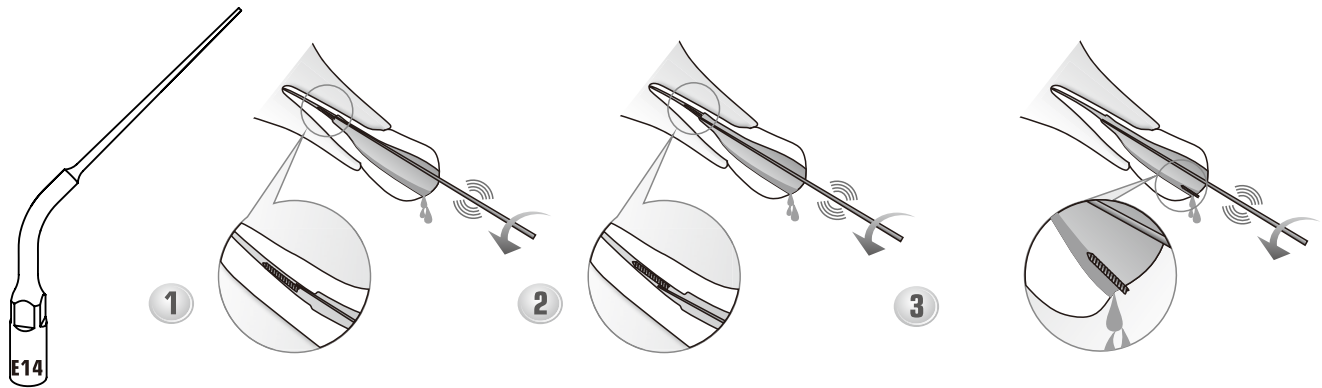

MODE: E
POWER

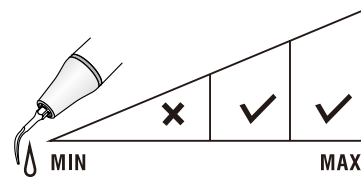
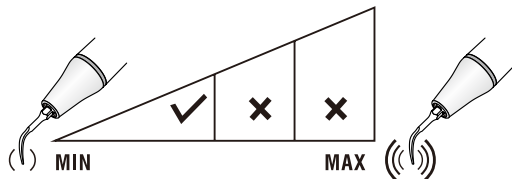

IRRIGATION

E14D(ED14D)

Diamond-coated(40um) instrument for removing the calcification and bad filling material in the root canal during the root canal retreatment. The length of the diamond-coated on tip is (15mm). With irrigation.

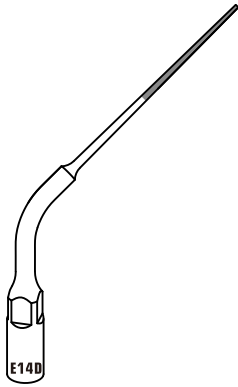

1

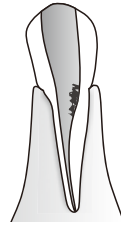

2

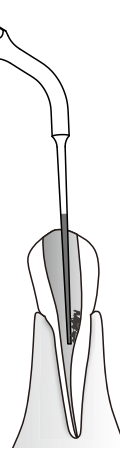

3

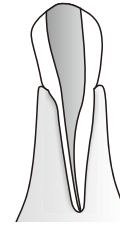

MODE: E
POWER

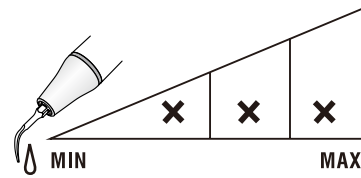
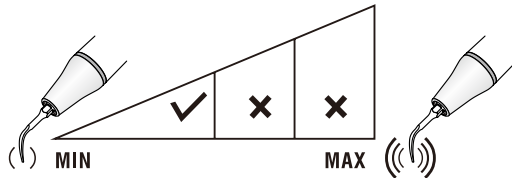

IRRIGATION

E15(ED15/ES15)

Instrument for the removal of broken files inside the root canal. The length of tip slender part is (16mm).

If possible place the patient's head in a position where the root canal is horizontal with a downward inclination. Rotate the tip of the instrument counterclockwise around the broken part until it is picked out from the root canal.

To avoid push the broken file deeper into the root canal, do not use pressure to the instrument in the axial direction.

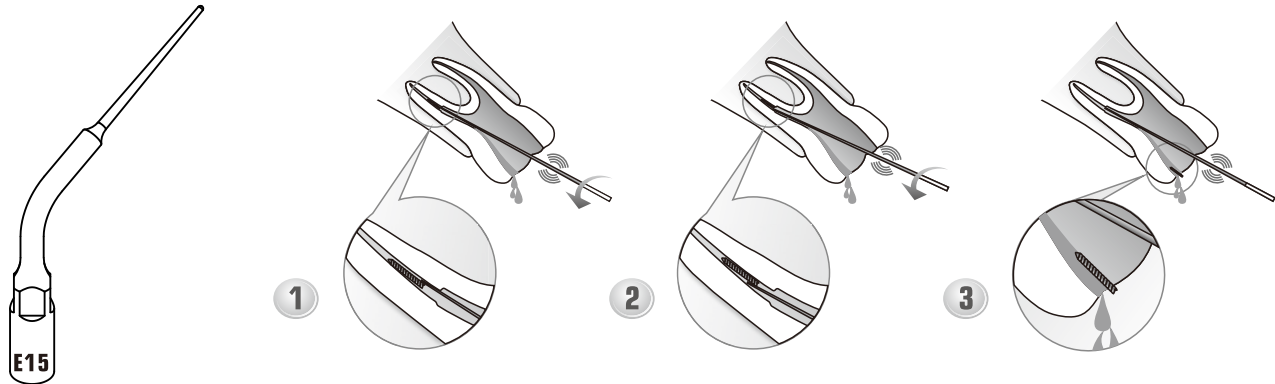

MODE: E
POWER

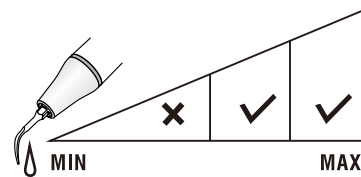
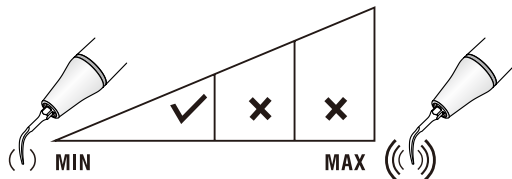

IRRIGATION

E15D(ED15D)

Diamond-coated(40um) instrument for removing the calcification and bad filling material in the root canal during the root canal retreatment. The length of the diamond-coated on tip is (10mm). With irrigation.

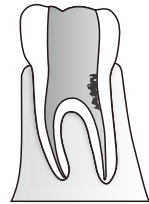
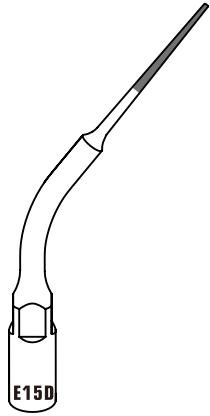

1

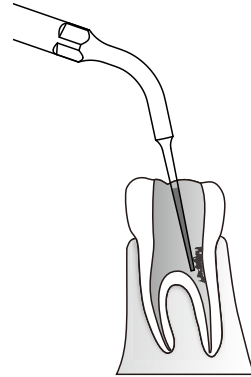

2

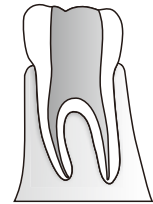

3

MODE: E
POWER

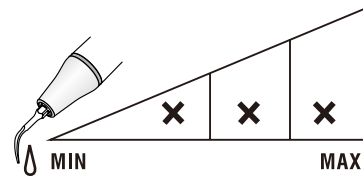
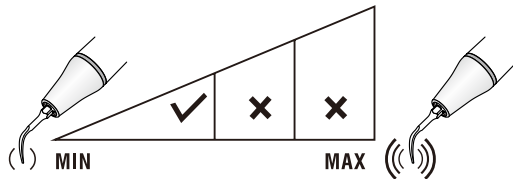

IRRIGATION

SB1 (SBD1)

Diamond-coated(85µm) instrument for removing the caries on occlusal surface of teeth and dental neck.

Place the instrument on the pit and move slowly into it with light pressure.

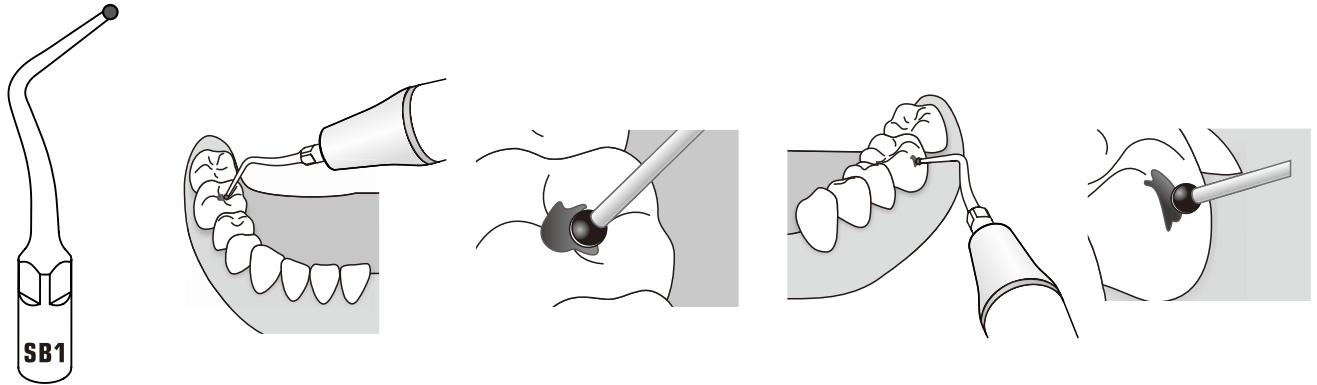

MODE: P
POWER

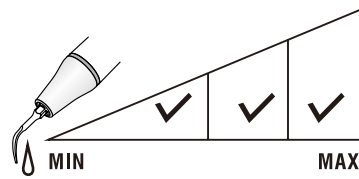
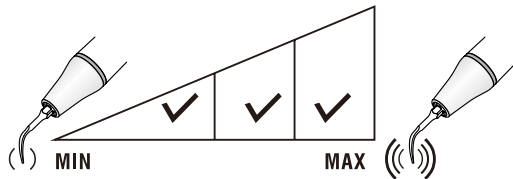

IRRIGATION



SB2 (SBD2)

Diamond-coated(85 μ m) instrument for removing the caries on Mesial surface of the adjacent teeth.

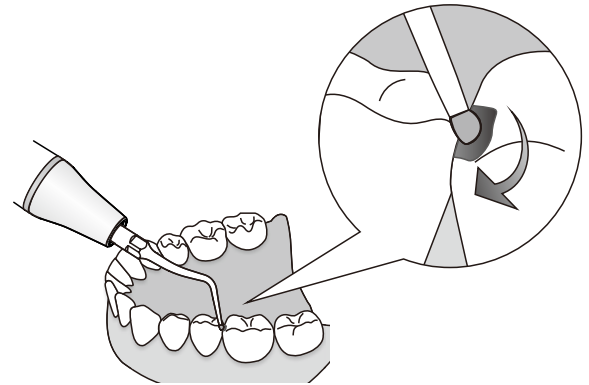
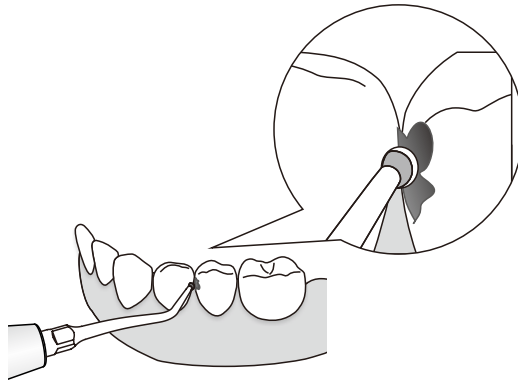
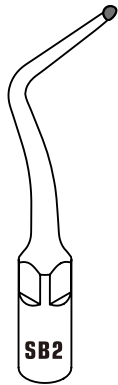

MODE: P
POWER

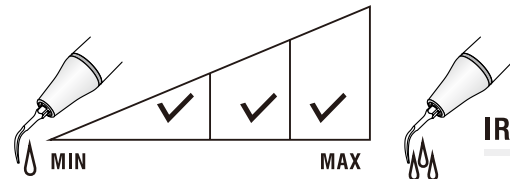
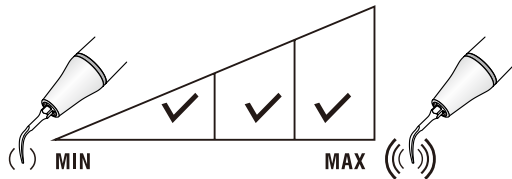

IRRIGATION

SB3 (SBD3)

Diamond-coated(85µm) instrument for removing the caries on Distal surface of the adjacent teeth.

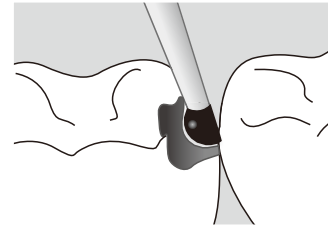
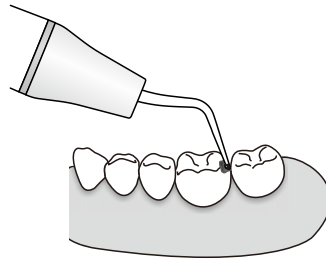
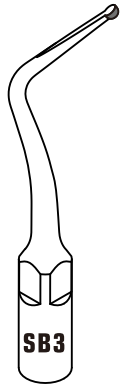

MODE: P
POWER

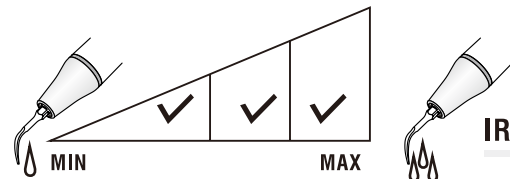
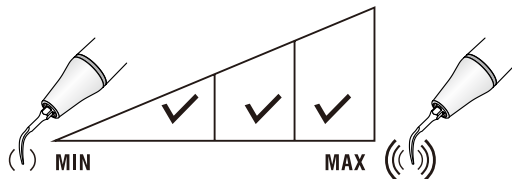

IRRIGATION

SBL(SBDL)

Diamond-coated(85µm) instrument for removing the dental caries, it will not hurt the adjacent teeth from right to left 45 degree.

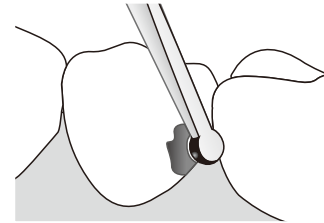
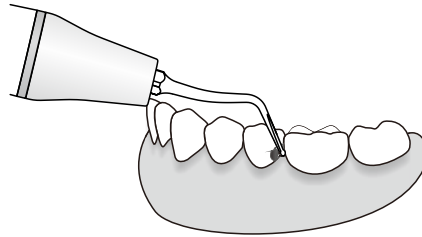
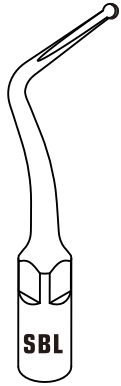

MODE: P
POWER

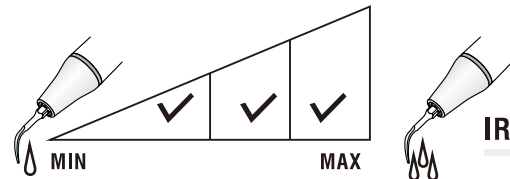
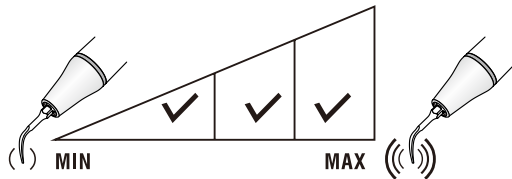

IRRIGATION

SBR(SBDR)

Diamond-coated(85µm) instrument for removing the dental caries, it will not hurt the adjacent teeth from left to right 45 degree.

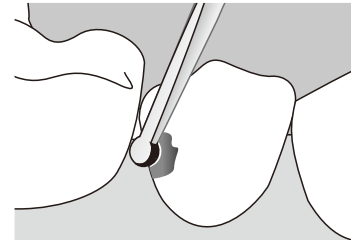
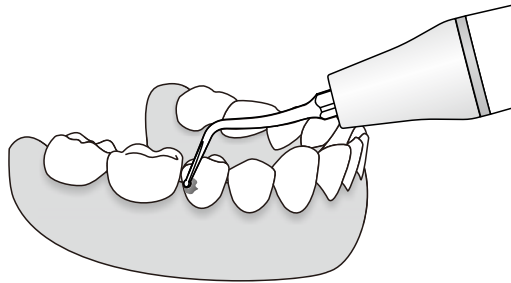
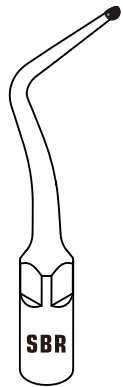

MODE: P
POWER

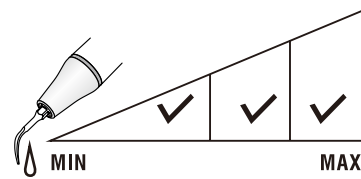
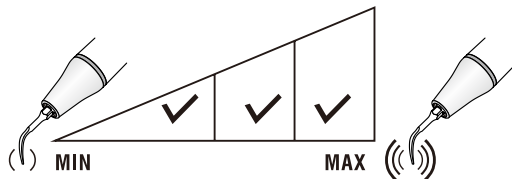

IRRIGATION

GK1

Removal of supragingival deposits in all quadrants.

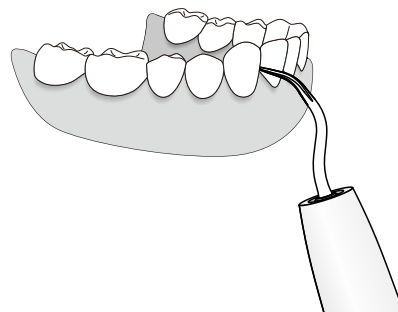
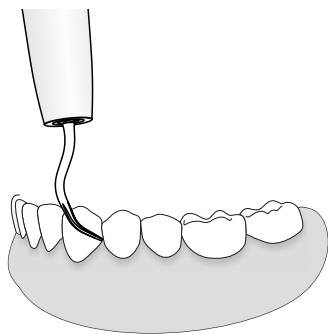

POWER

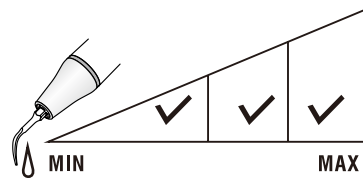
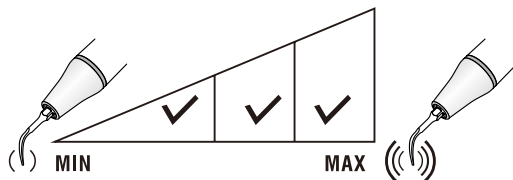

IRRIGATION

GK2

Removal of supragingival heavy calculus and plaque.

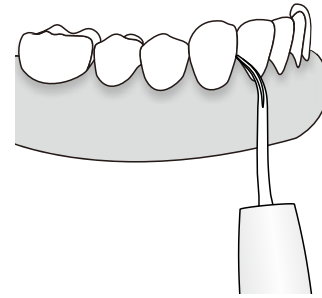
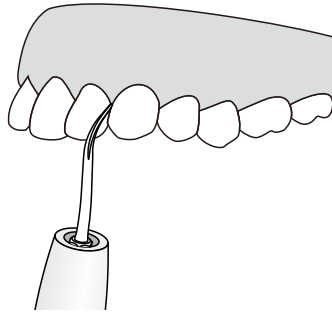

POWER

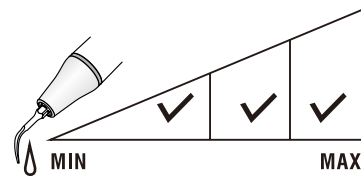
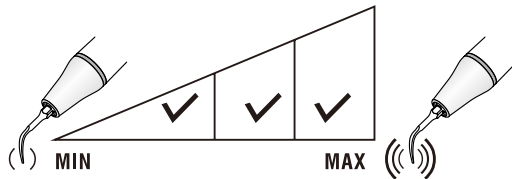

IRRIGATION

GK3

Removal of supragingival calculus, interdental calculus and calculus at the neck of the teeth.

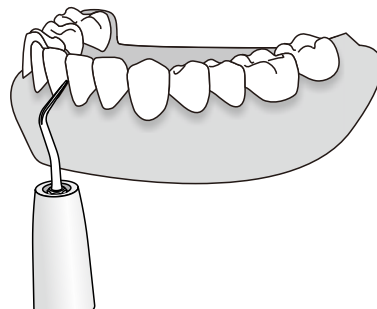
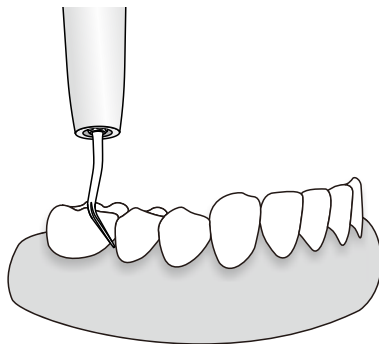

POWER

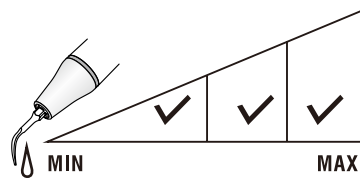
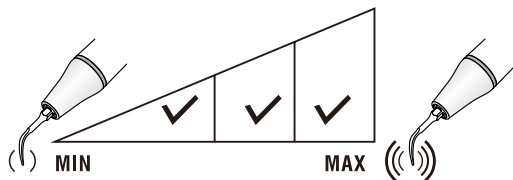

IRRIGATION

GK4

Removal of supragingival deposits, including the interproximal and sulcus areas.

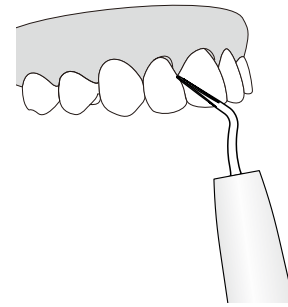
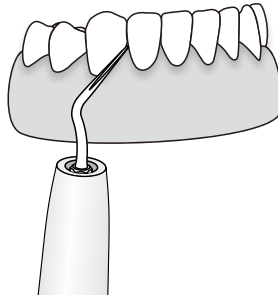
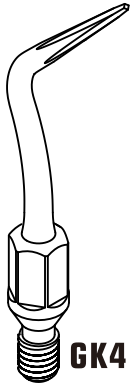

POWER

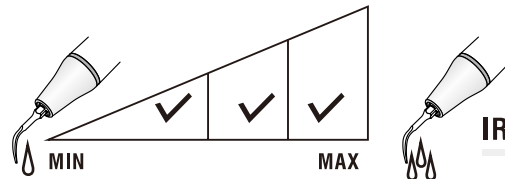
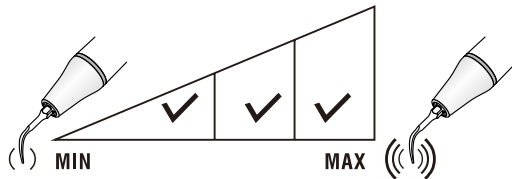

IRRIGATION

GK5

Removal of subgingival calculus.

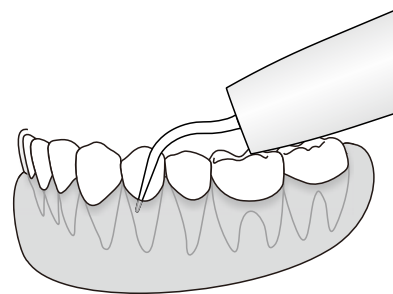
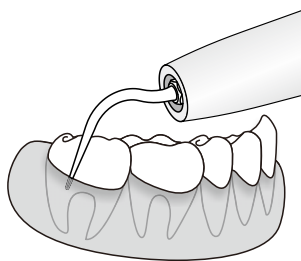
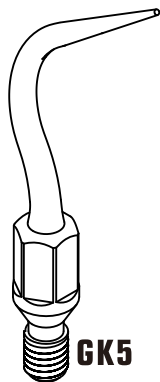

POWER

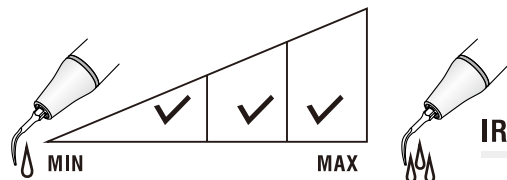
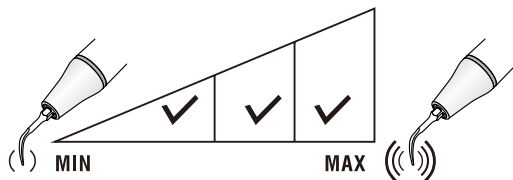

IRRIGATION

GK6

Left-angled, removal of subgingival calculus.

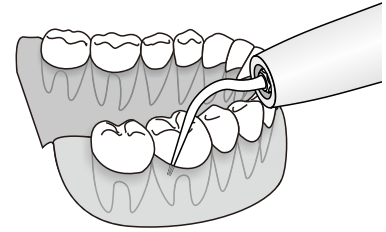
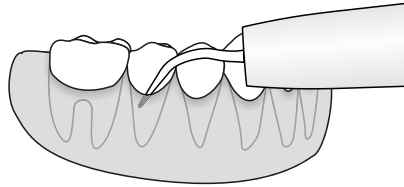
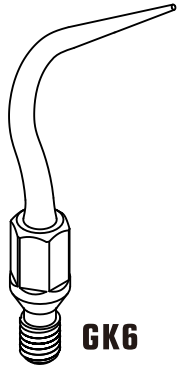

POWER

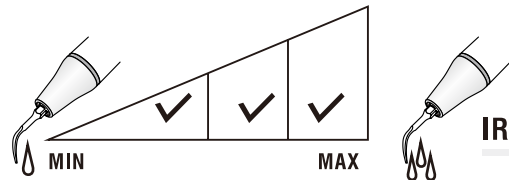
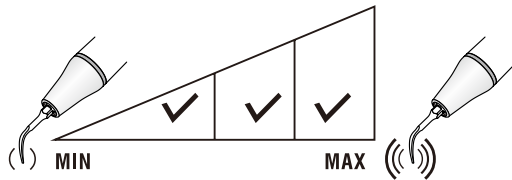

IRRIGATION

GK7

Right-angled, removal of subgingival calculus.

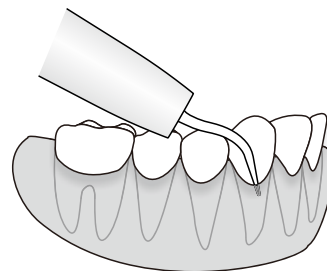
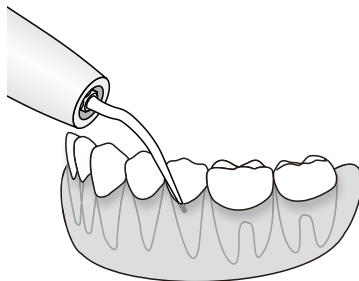
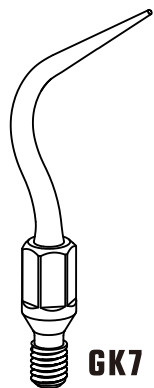

POWER

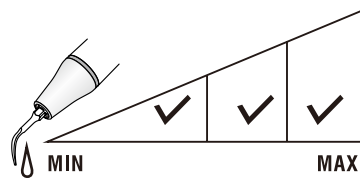
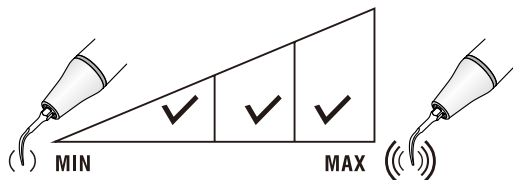

IRRIGATION

Gk20

There are diamonds coated (120um grit) on the head of the tip for dentin abrading.

It's used for "supragingival shoulder" preparation after the completion of the preparation of the "subgingival shoulder" with bur.

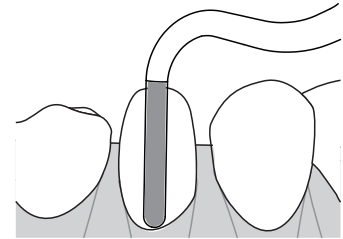
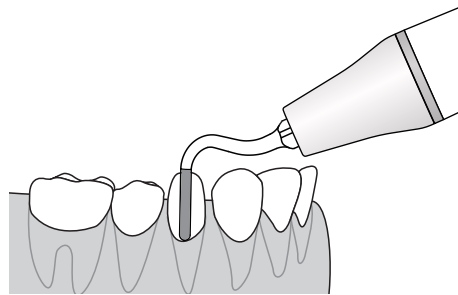
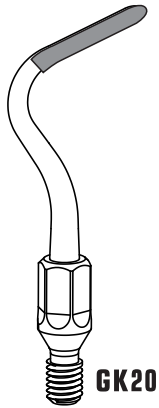

POWER

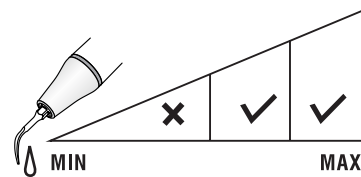
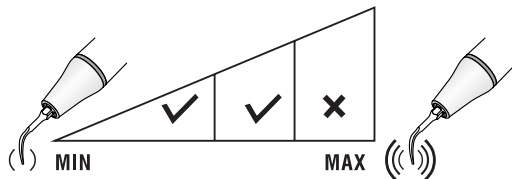

IRRIGATION

Gk21

There are diamonds coated (50um fine sand) on the head of the tip for dentin abrading, mainly used for polishing of prepared supragingival shoulder and subgingival shoulder.

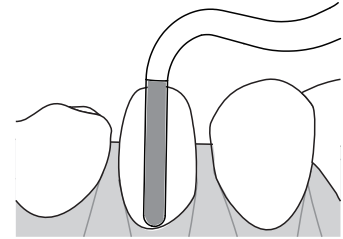
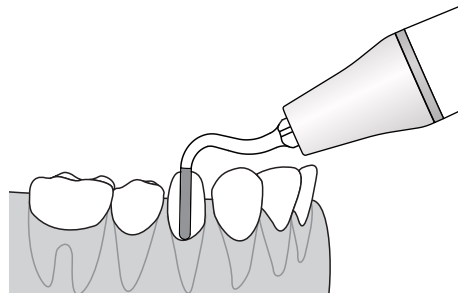
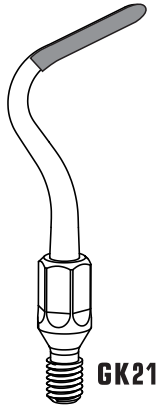

POWER

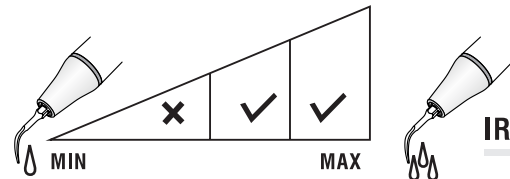
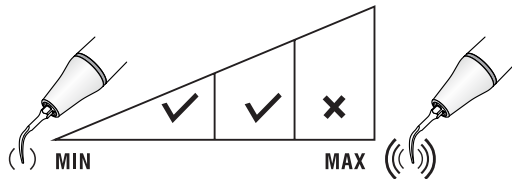

IRRIGATION

GC1

Removal of supragingival deposits in all quadrants.

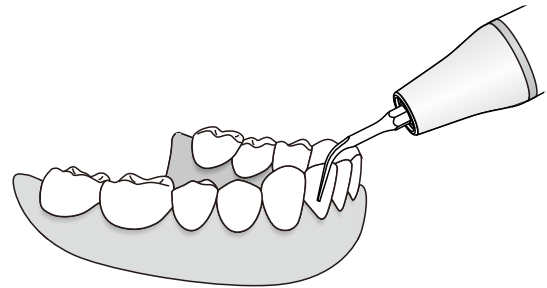
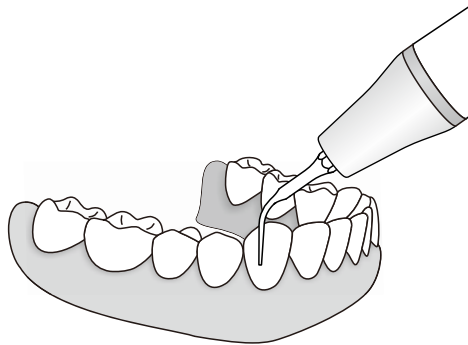
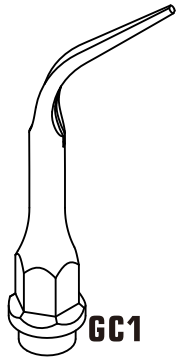

MODE: G
POWER

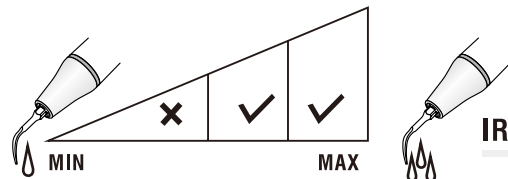
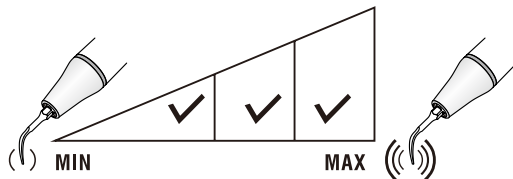

IRRIGATION

GC2

Removal of supragingival calculus, interdental calculus and calculus at the neck of the teeth.

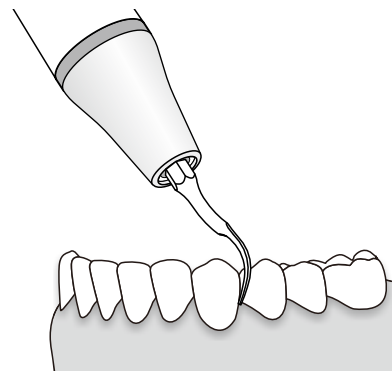
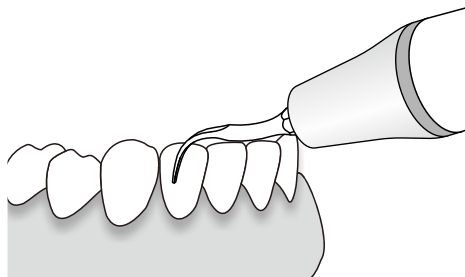

MODE: G
POWER

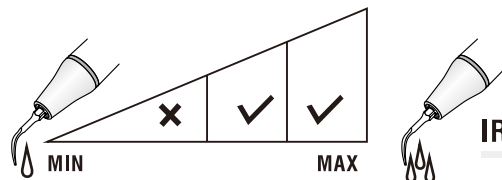
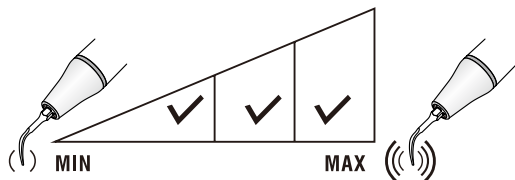

IRRIGATION

PC1

Removal of subgingival calculus, including the interproximal and sulcus areas.

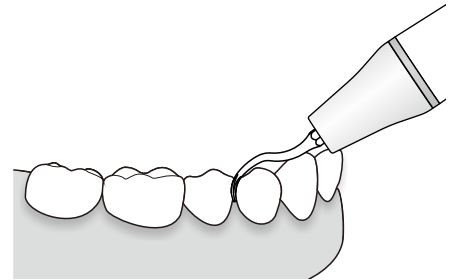
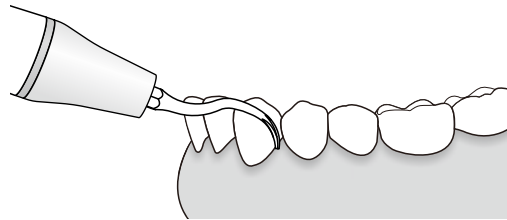
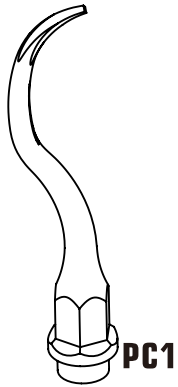

MODE: P
POWER

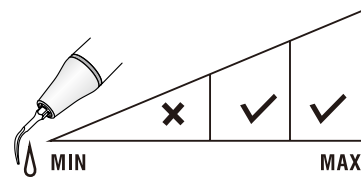
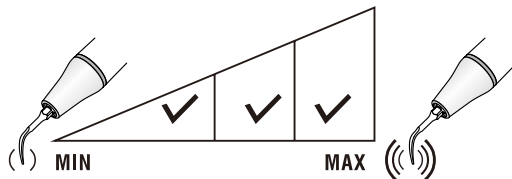

IRRIGATION

A1

Removal of supragingival deposits, including the interproximal and sulcus areas.

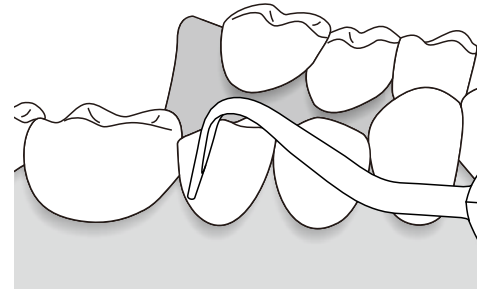
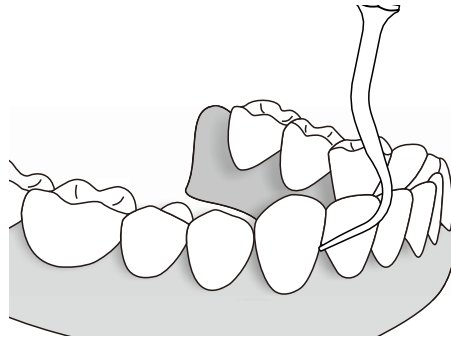
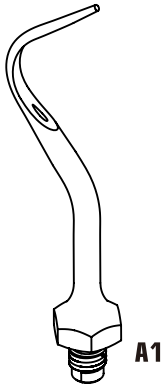

POWER

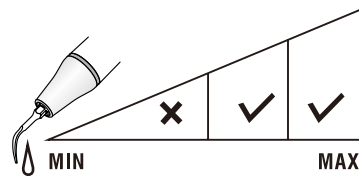
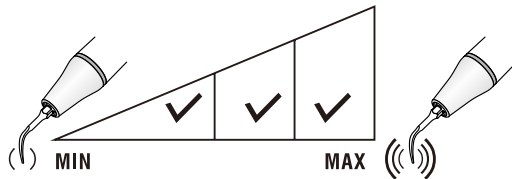

IRRIGATION

A2

Removal of supragingival deposits in all quadrants, including neck and adjacent part of the teeth.

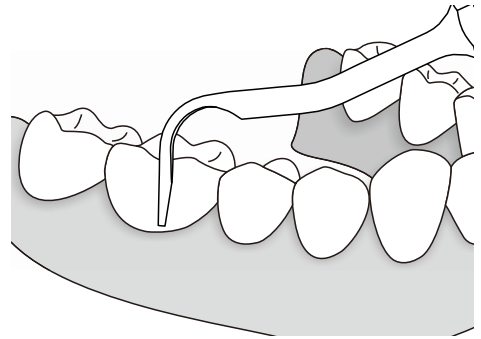
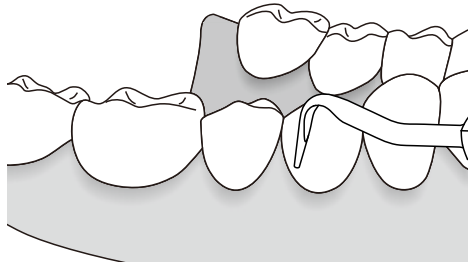
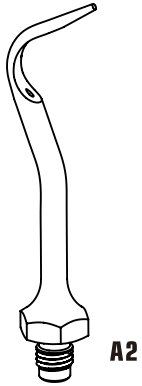

POWER

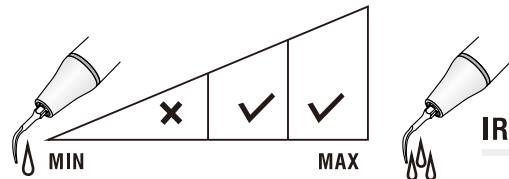
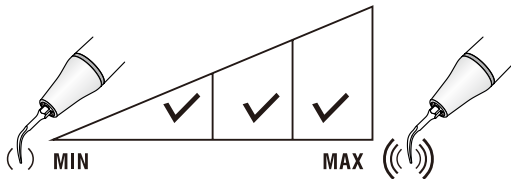

IRRIGATION

US1

High effectiveness osteotomy of large bone sections during maxillofacial surgery, it can also be used for exodontia exodontics.

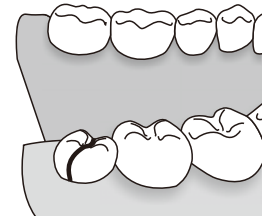
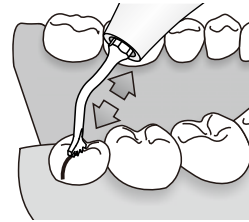
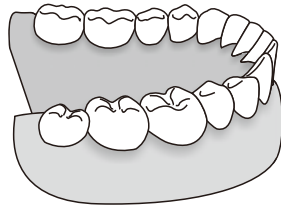
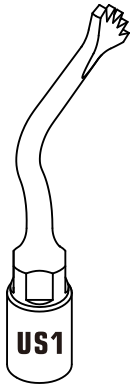

MODE: BONE

POWER: Quality1, Quality2, Quality3
(Cortical/Spongious)

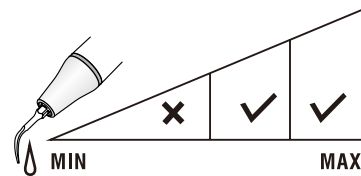

IRRIGATION

US1L

Left angle 90°, horizontal osteotomy technique in maxilla and mandible.

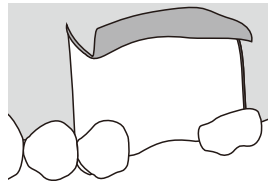
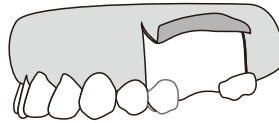

1

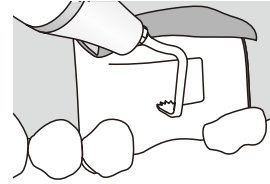

2

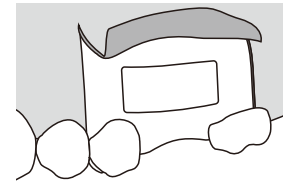

3

MODE: BONE

POWER: Quality1, Quality2, Quality3
(Cortical/Spongius)

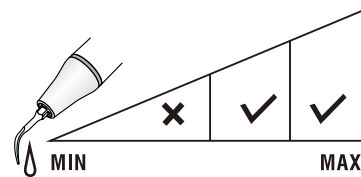

IRRIGATION

US1R

Right angle 90°, horizontal osteotomy technique in maxilla and mandible.

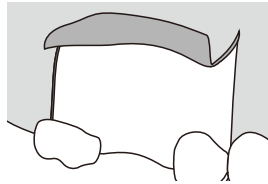
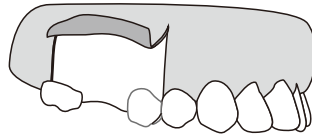
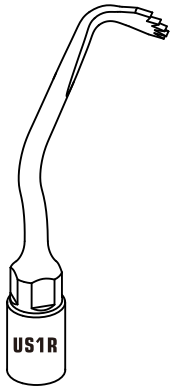

1

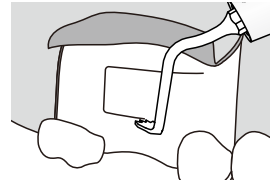

2

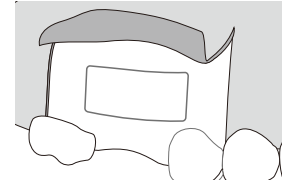

3

MODE: BONE

POWER: Quality1, Quality2, Quality3
(Cortical/Spongius)

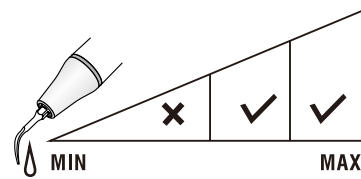

IRRIGATION

US2

High effectiveness osteotomy technique in maxilla and mandible(ridge expansion, corticotomy technique, bone block grafting).

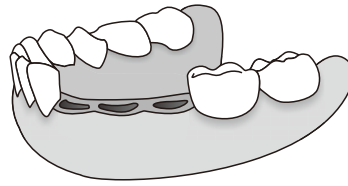
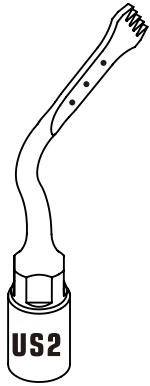

1

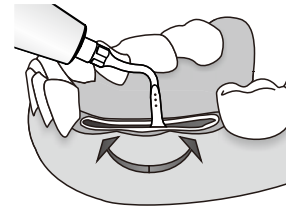

2

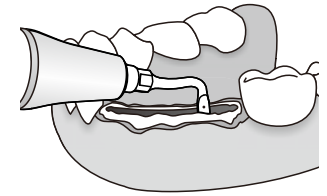

3

MODE: BONE

POWER: Quality1, Quality2, Quality3
(Cortical/Spongiuous)

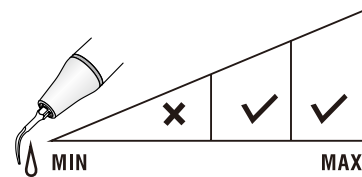

IRRIGATION

US3

Osteotomy: osteotome of great precision in anatomically thin structures.

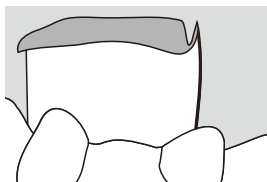
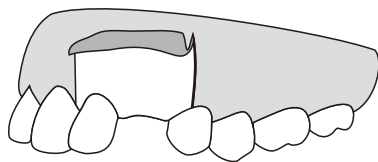
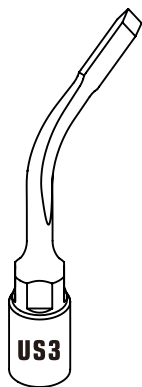

1

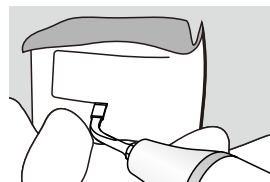

2

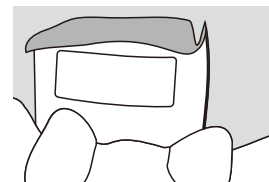

3

MODE: BONE

POWER: Quality1, Quality2, Quality3
(Cortical/Spongious)

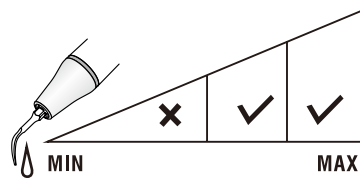

IRRIGATION

US4

Universal osteoplasty: periodontal osteotomy, bone chips harvesting, inflammatory tissue removal (cyst, etc.).

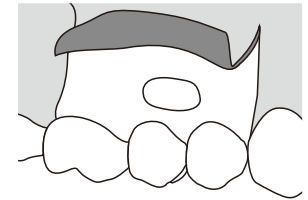
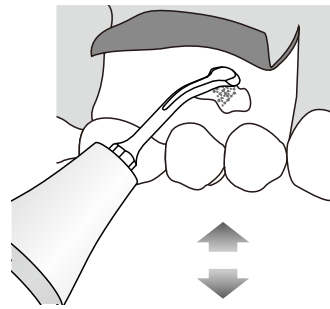
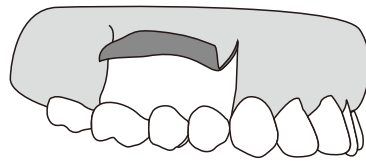
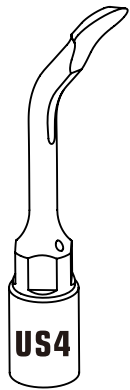

MODE: BONE

POWER: Quality1, Quality2, Quality3
(Cortical/Spongius)

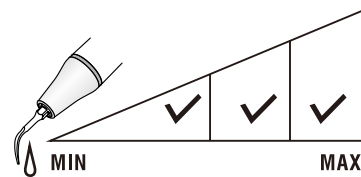

US5

High efficiency bone osteoplasty: bone remodelling and harvesting of bone chips.

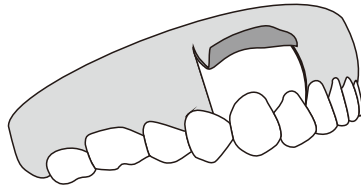
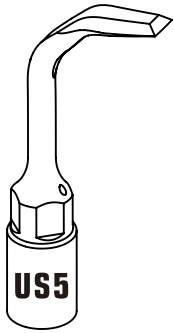

1

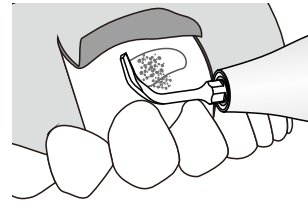

2

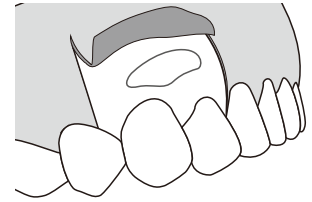

3

MODE: BONE

POWER: Quality1, Quality2, Quality3
(Cortical/Spongious)

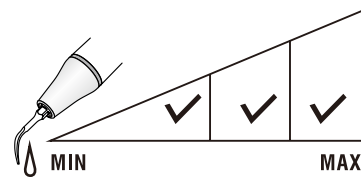

IRRIGATION

US6

Osteotomy: osteotome of great precision in anatomically thin structures (ridge expansion, corticotomy technique).

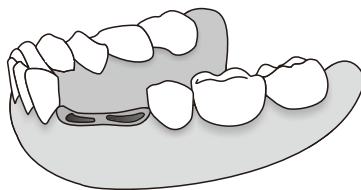
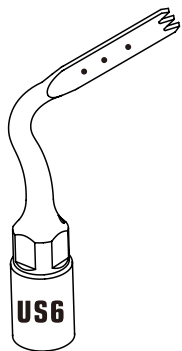

1

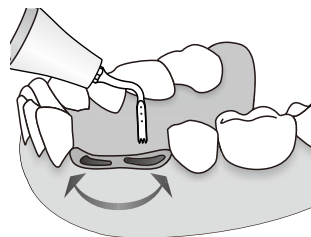

2

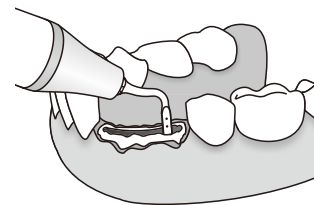

3

MODE: BONE

POWER: Special

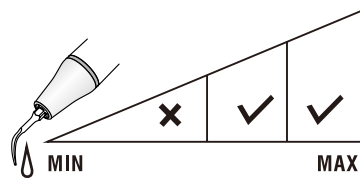

IRRIGATION

US13

For osteotomy and the removal of apex in posterior teeth area.

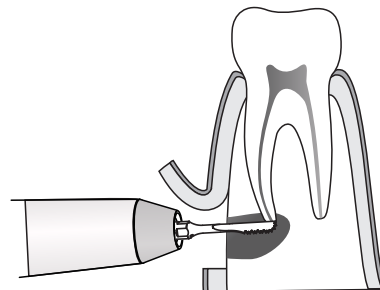
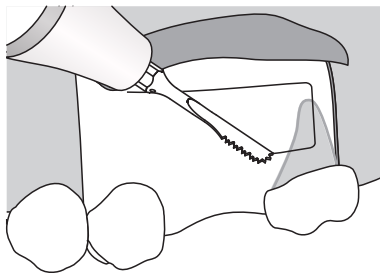

MODE: BONE

POWER: Special

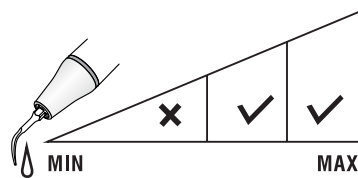

IRRIGATION

US21

Used for bone cutting. Fan-shaped serration, more convenient for cutting in different angle.

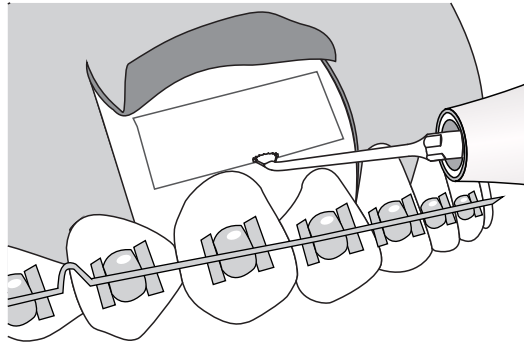
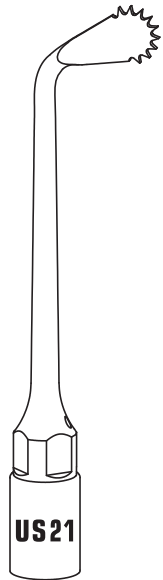

MODE: BONE

POWER: Special

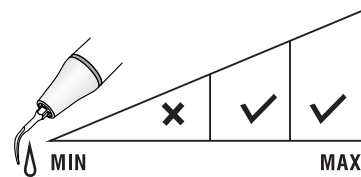

IRRIGATION

US25

Used for bone surgery.

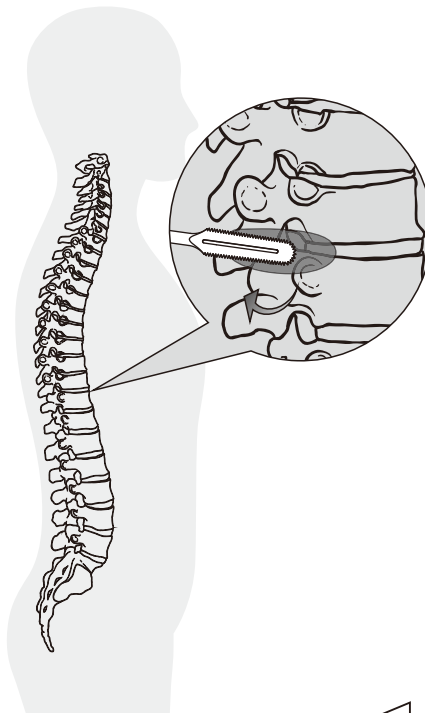
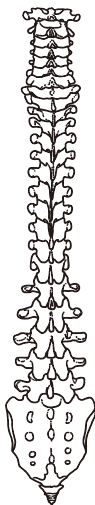

MODE: BONE

POWER: Special

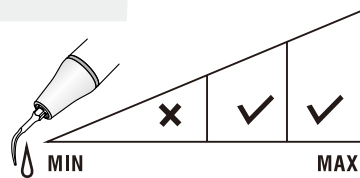

IRRIGATION

UL1

Tip angle 120°, separation of the sinus membrane in internal zones, non-cutting elevator of the sinus membrane.

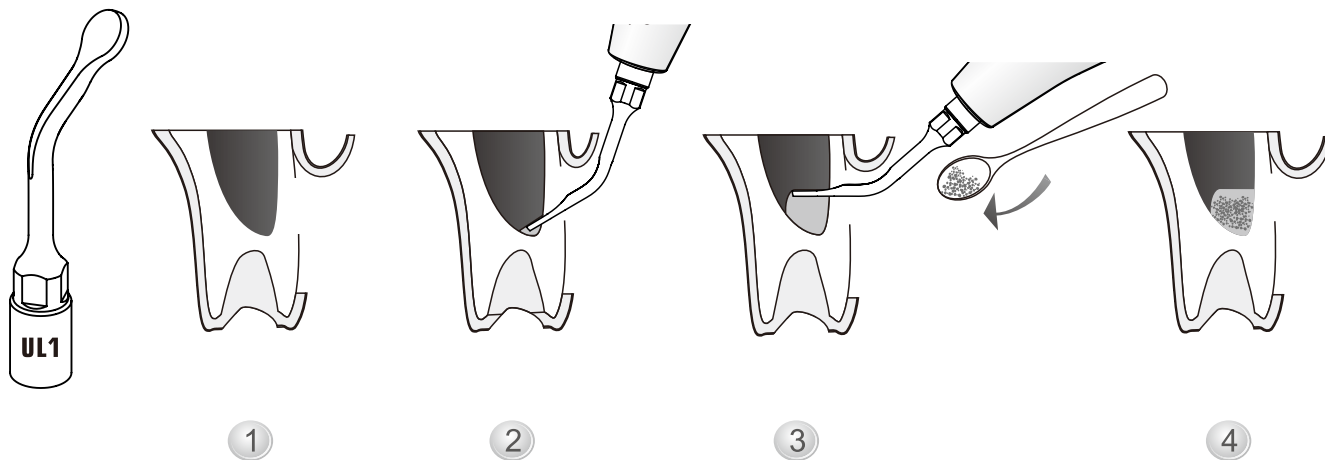

MODE: ROOT

POWER: Endo(Maximum power permitted)

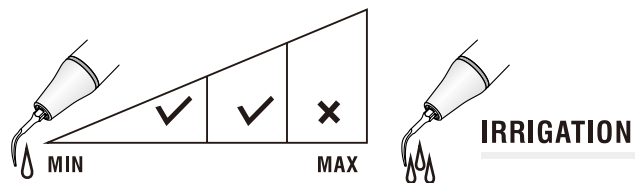

UL2

Schneiderian membrane separation from bony walls: separation of the sinus membrane.

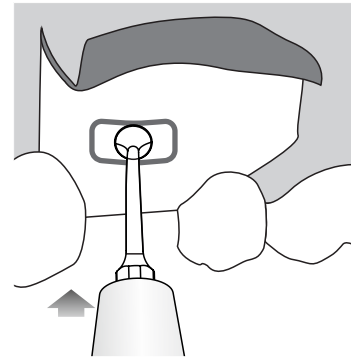
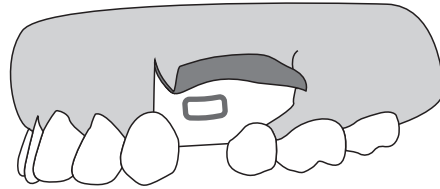
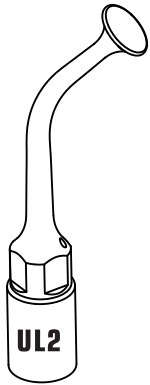

MODE: ROOT

POWER: Endo(Maximum power permitted)

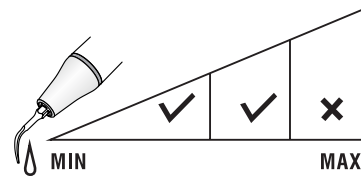

IRRIGATION

UL3

Diamond-coated(100 μ m) instrument for micrometric osteotomy or osteoplasty: non-traumatic, to finalize the osteotomy or osteoplasty on thin bone and/or near delicate anatomic structures.

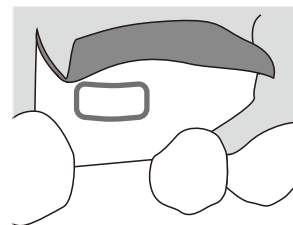
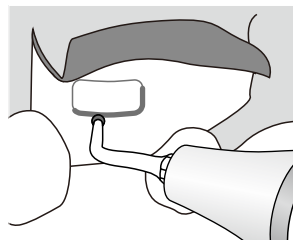
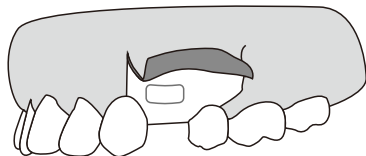
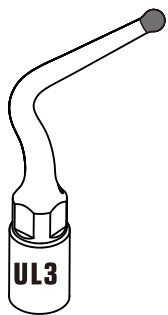

MODE: BONE

POWER: Quality1, Quality2, Quality3
(Cortical/Spongious)

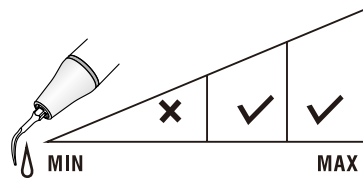

IRRIGATION

UL4

Diamond-coated(100µm) instrument for micrometric osteotomy: to finalize the osteotomy in proximity of soft tissue (sinus membrane, vessel, alveolar nerve).

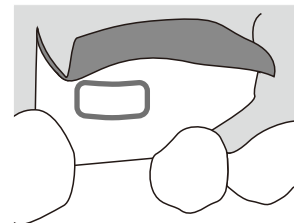
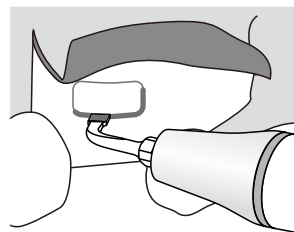
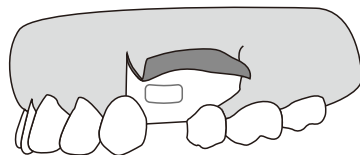
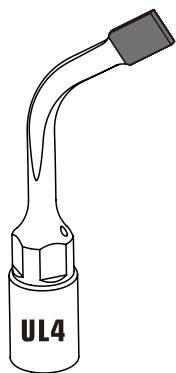

MODE: BONE

POWER: Quality1, Quality2, Quality3
(Cortical/Spongious)

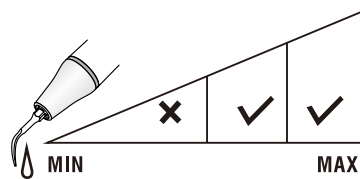

IRRIGATION

UL5

Tip angle 95°, separation of the sinus membrane in internal zones, non-cutting elevator of the sinus membrane.

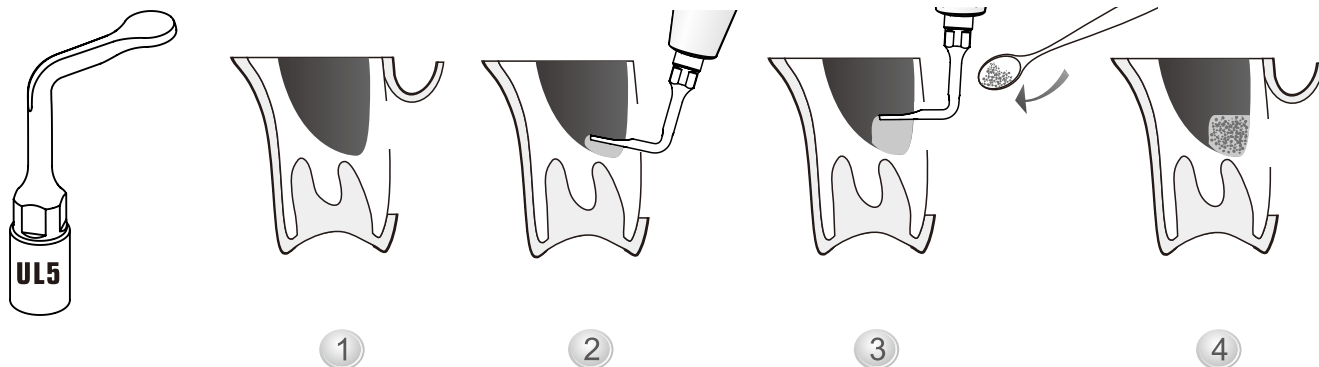

MODE: ROOT

POWER: Endo(Maximum power permitted)

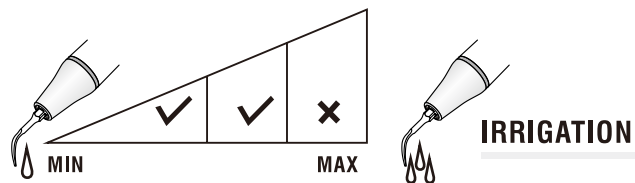

UL8

Diamond-coated head (100 μ m), used for non-traumatic osteotomy and osteoplasty near soft tissue and thin bone region.

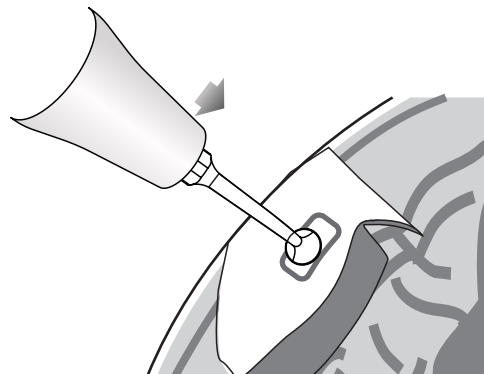
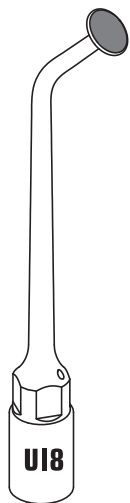

MODE: ROOT

POWER: Endo(Maximum power permitted)

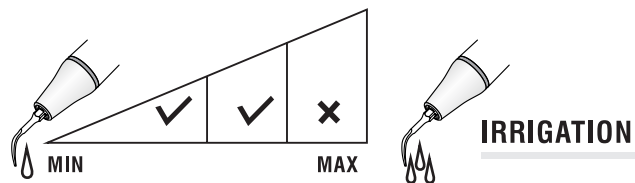

UE1

Diamond-coated(40 μ m) instrument for apical root debridement: diamond-coated instrument for efficient root planning. The length of the diamond-coated on tip is (3.3mm).

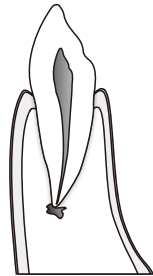
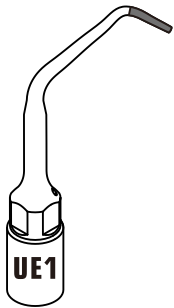

1

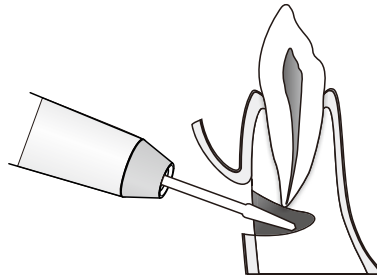

2

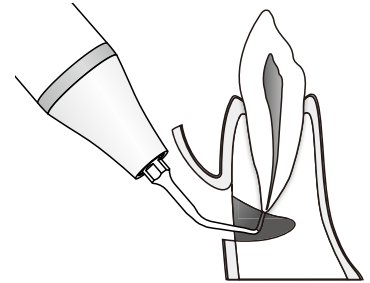

3

MODE: ROOT

POWER: Endo(Maximum power permitted)

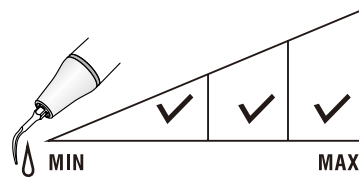

IRRIGATION

UE2

Used for gentle canal cleaning. The length of tip slender smooth part is (4.5mm).

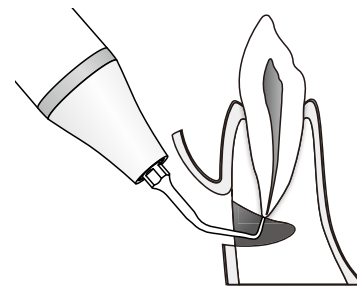
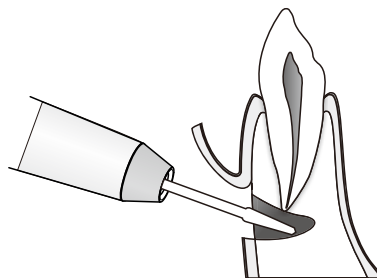
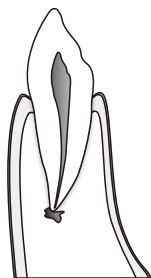
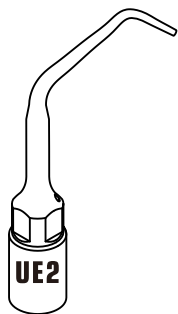

MODE: ROOT

POWER: Endo(Maximum power permitted)

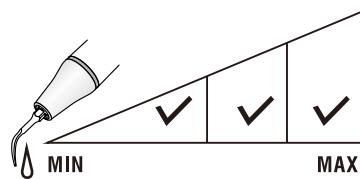

IRRIGATION

UE3

Diamond-coated(40µm) instrument for apical root debridement: diamond-coated instrument for efficient root planning. The length of the diamond-coated on tip is (2.2mm).

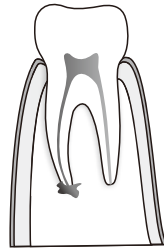
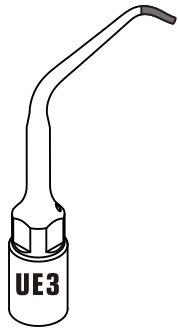

1

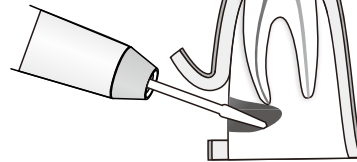

2



3

MODE: ROOT

POWER: Endo(Maximum power permitted)

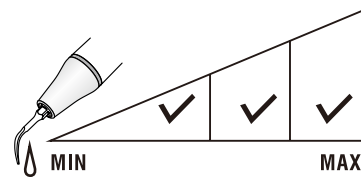

IRRIGATION

UE4

Used for gentle canal cleaning. The length of tip slender smooth part is (3.5mm).

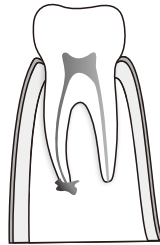
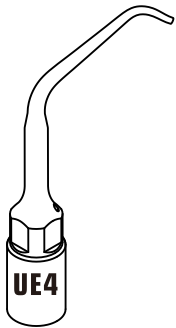

1

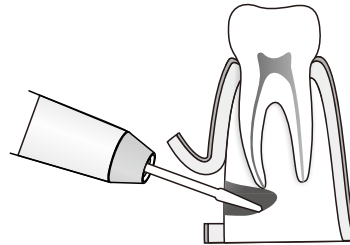

2

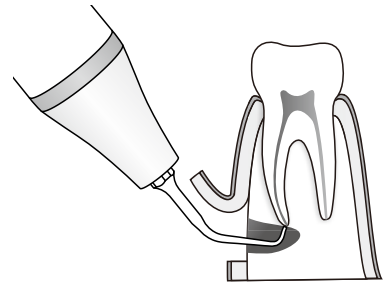

3

MODE: ROOT

POWER: Endo(Maximum power permitted)

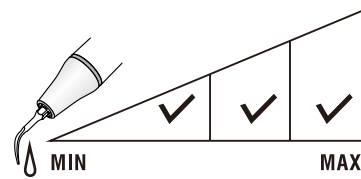

IRRIGATION

UC1

Used to cut off the ankylosis and root fraction techniques.

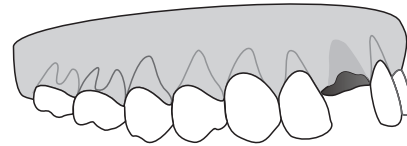
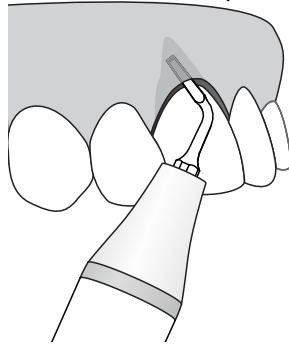
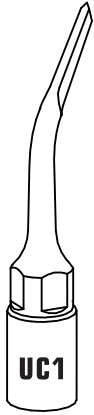

MODE: BONE

POWER: Quality1, Quality2, Quality3
(Cortical/Spongious)

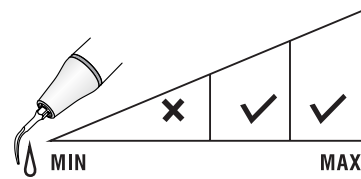

IRRIGATION

UC2

Left curved, Used to cut off the ankylosis, root fraction techniques in the posterior regions.

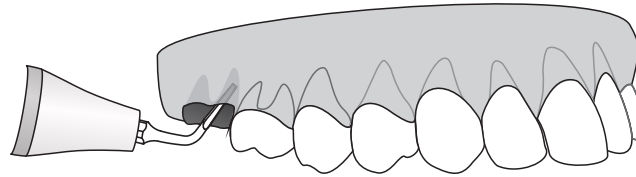

MODE: BONE

POWER: Quality1, Quality2, Quality3
(Cortical/Spongious)

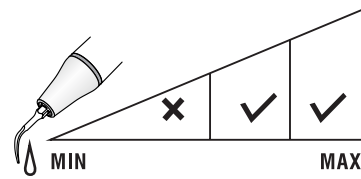

IRRIGATION

UC3

Right curved, Used to cut off the ankylosis, root fraction techniques in the posterior regions.

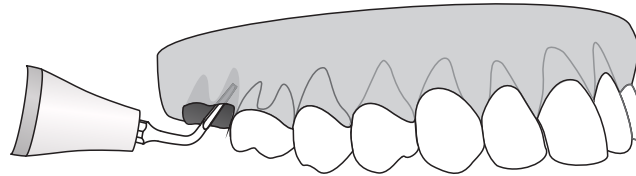

MODE: BONE

POWER: Quality1, Quality2, Quality3
(Cortical/Spongius)

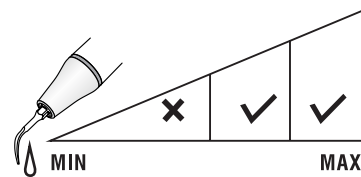

IRRIGATION

UC6

For teeth extraction and alveolar bone splitting

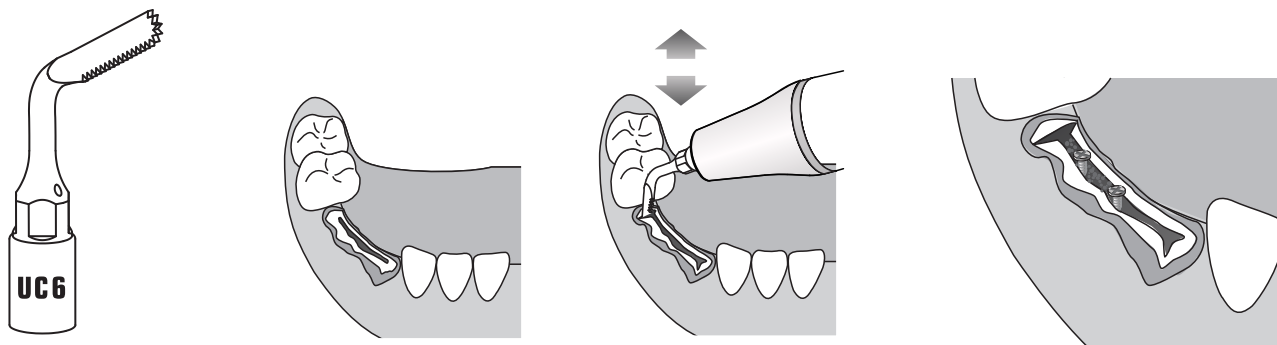

MODE: BONE

POWER: Quality1, Quality2, Quality3
(Cortical/Spongious)

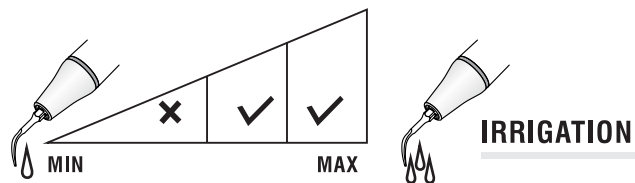

UC7

For teeth extraction and alveolar bone splitting

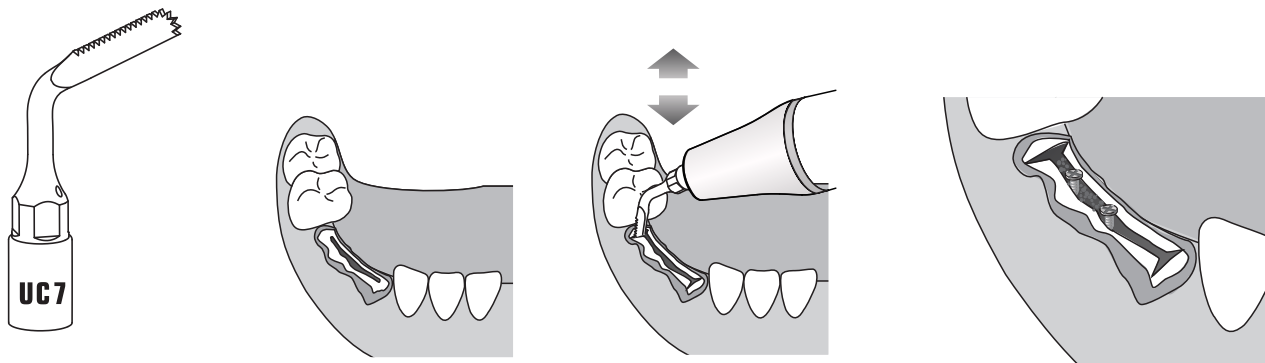

MODE: BONE

POWER: Quality1, Quality2, Quality3
(Cortical/Spongious)

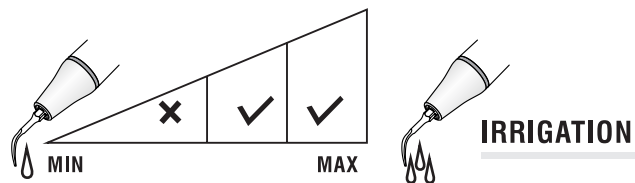

U11

Ø1.6mm implantation site preparation insert. The working length of the tip is (9mm).

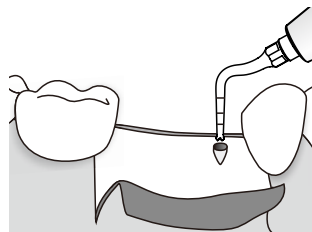
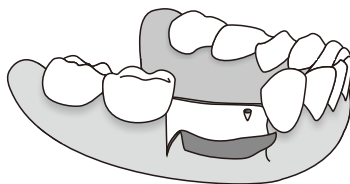
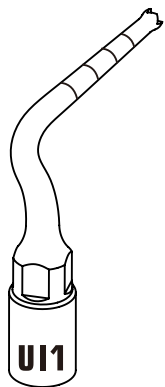

1

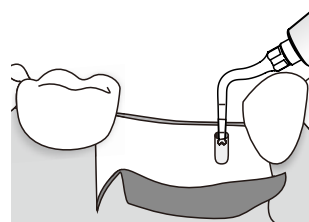

2

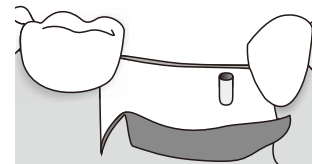

3

MODE: BONE

POWER: Quality1, Quality2, Quality3
(Cortical/Spongious)

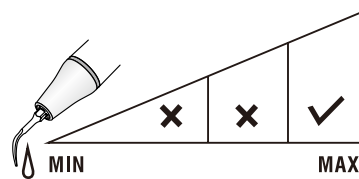

IRRIGATION

U12

Ø2mm implantation site preparation insert. The hole at the center of the top for water spray maximum reduce the heat.

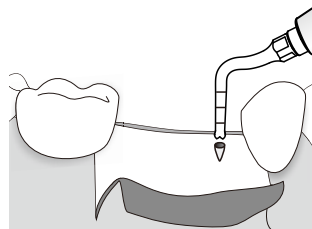
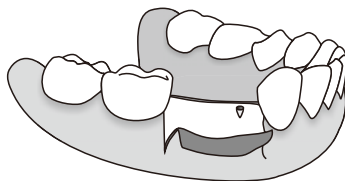
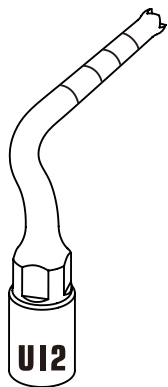

1

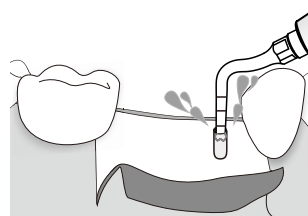

2

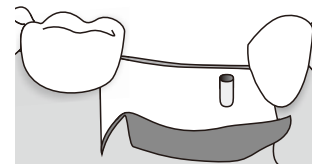

3

MODE: BONE

POWER: Quality1, Quality2, Quality3
(Cortical/Spongious)

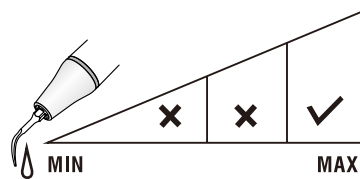

IRRIGATION

U17

Diamond-coated(85µm) instrument for finalizing the implantation site preparation close to the alveolar nerve.

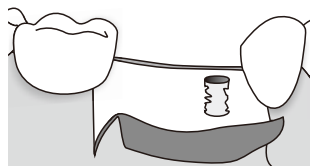
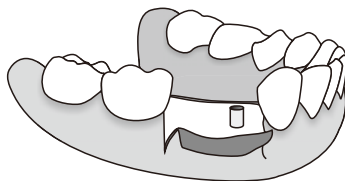
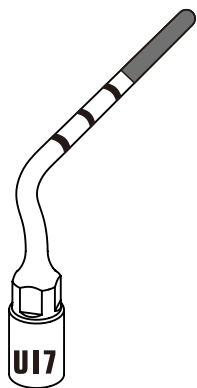

1

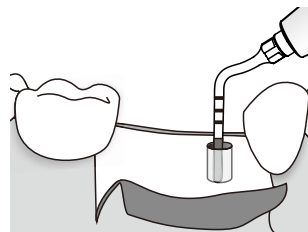

2

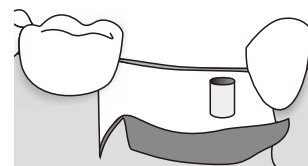

3

MODE: BONE

POWER: Quality1, Quality2, Quality3
(Cortical/Spongious)

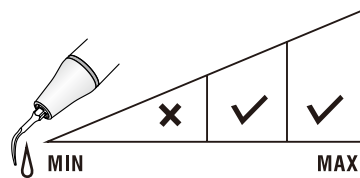

IRRIGATION

U18

Ø1.6mm implantation site preparation insert. The working length of the tip is (15mm).

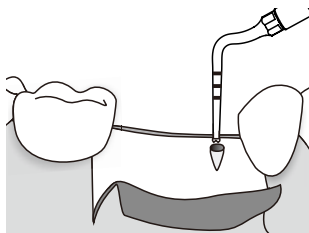
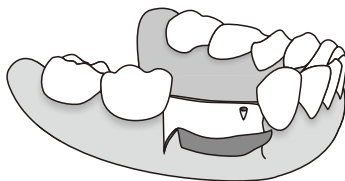
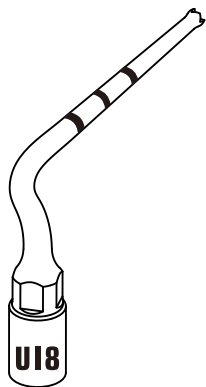

1

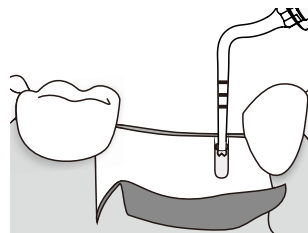

2

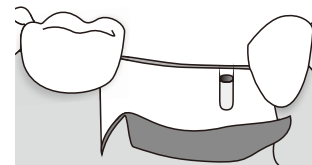

3

MODE: BONE

POWER: Quality1, Quality2, Quality3
(Cortical/Spongius)

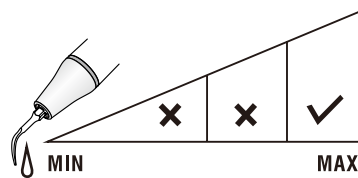

IRRIGATION

U19

Ø2.8mm implantation site preparation insert . The hole at the center of the top for water spray maximum reduce the heat.

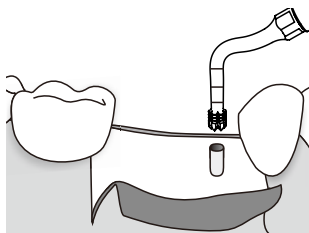
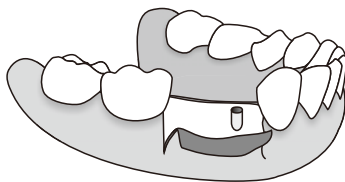
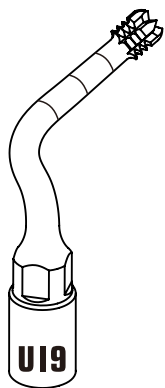

1

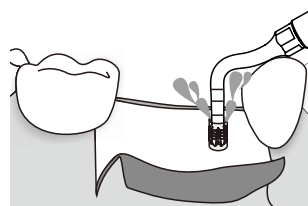

2

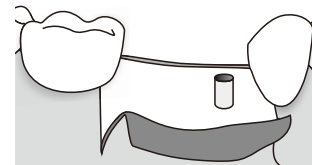

3

MODE: BONE

POWER: Quality1, Quality2, Quality3
(Cortical/Spongious)

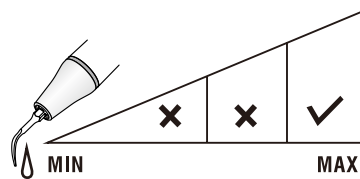

IRRIGATION

UP1

Recommended for periodontal gentle curetting scaling.

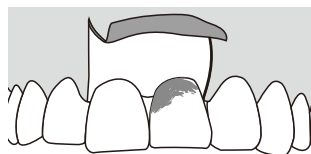
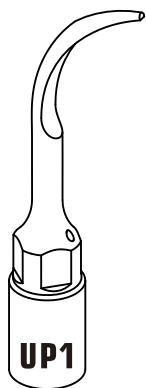

1

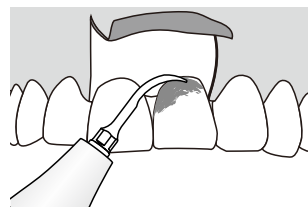

2

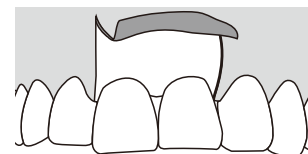

3

MODE: ROOT

POWER: PERIO

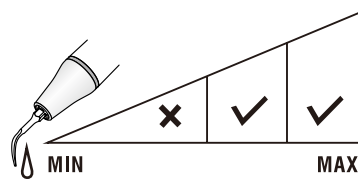

IRRIGATION

UP2

Inflammatory tissue removal and fractured root apex extraction.

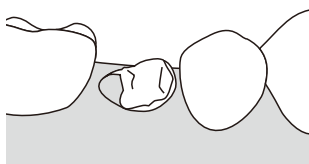
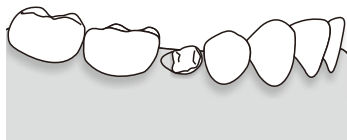
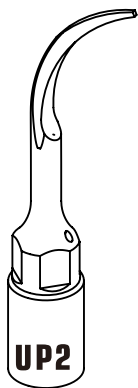

1

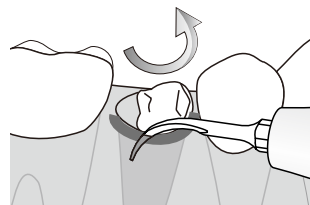

2

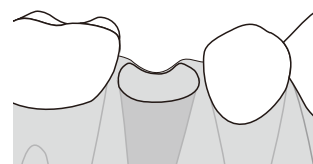

3

MODE: ROOT

POWER: PERIO

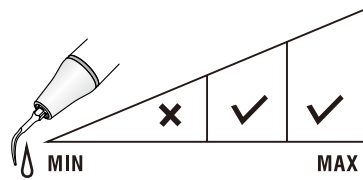

IRRIGATION

UP3

Recommended for angled periodontal gentle curetting scaling.

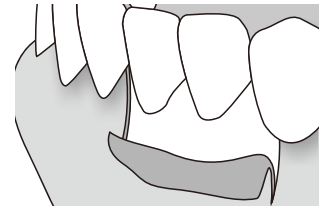
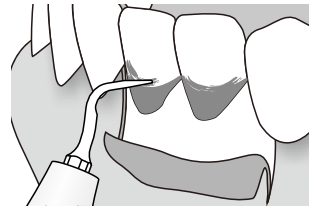
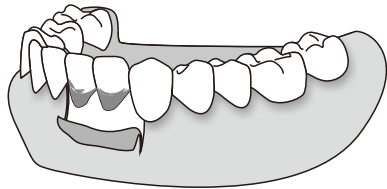
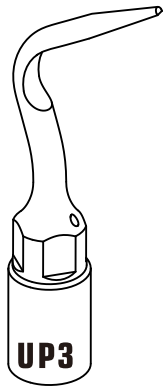

MODE: ROOT

POWER: PERIO

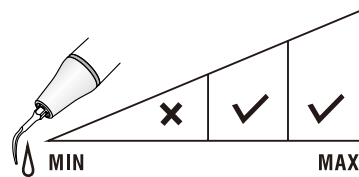

IRRIGATION

UP4

Diamond-coated(40µm) instrument for root debridement and root planning.

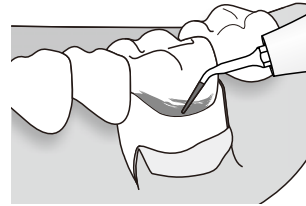
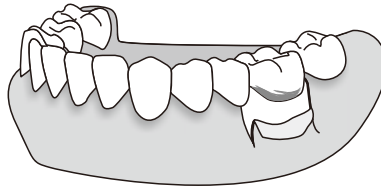
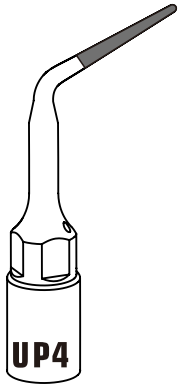

1

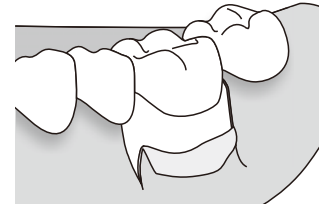

2

MODE: ROOT

POWER: PERIO

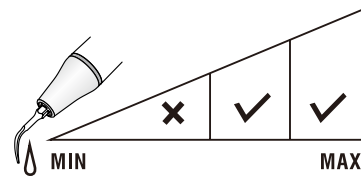

IRRIGATION

UP5

Recommended for root surface micro-smoothing.

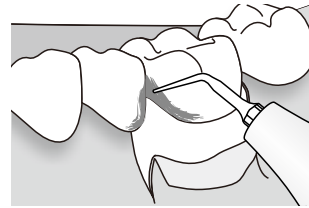
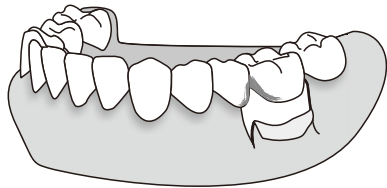
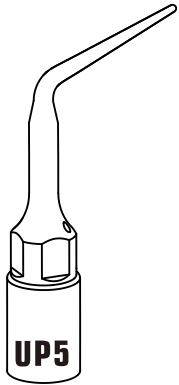

1

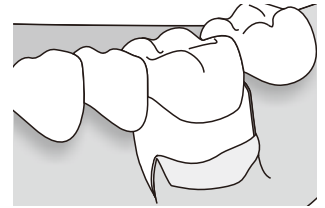

2

MODE: ROOT

POWER: PERIO

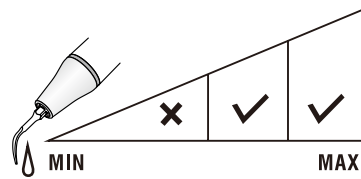

IRRIGATION

UP6

Diamond-coated(40µm) instrument for micro-osteoplasty: interproximal osteoplasty and root planning.

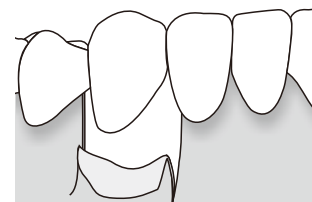
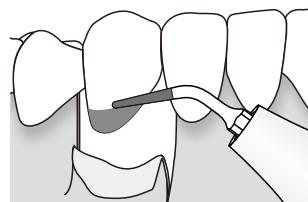
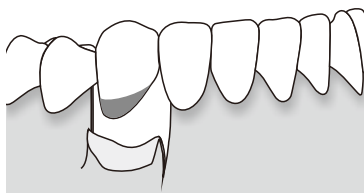
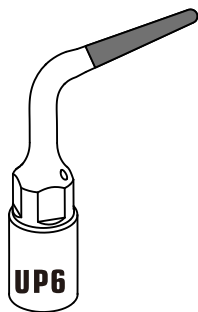

1

2

MODE: ROOT

POWER: Quality1, Quality2, Quality3
(Cortical/Spongious)

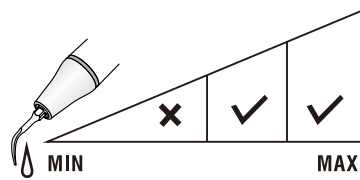

IRRIGATION

UP7

Diamond-coated(40 μ m) instrument for root canal orientation and removal of the calcifications located at the 1/3 part of root canal, it can also be used for micro-osteoplasty.

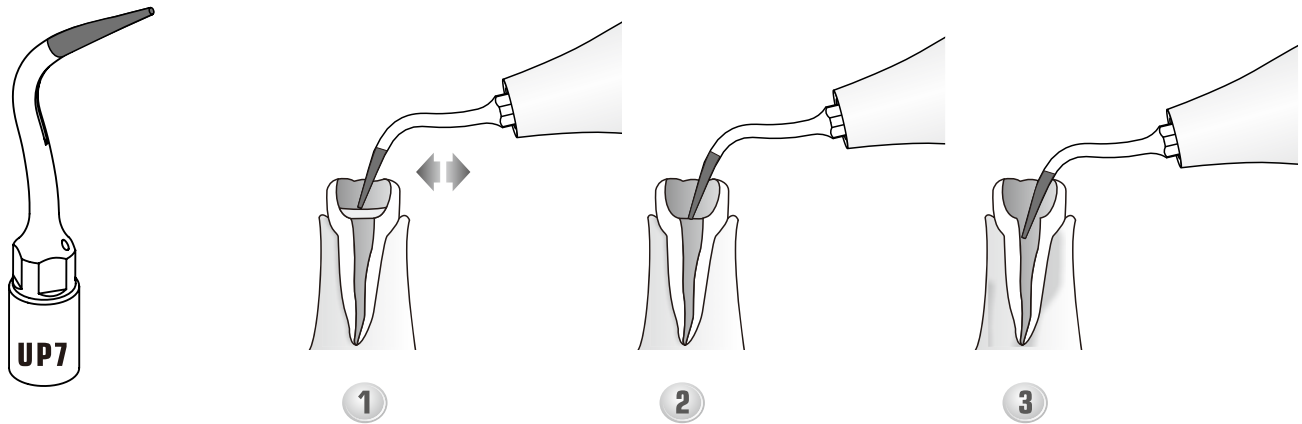

MODE: ROOT

POWER: Endo(Maximum power permitted)

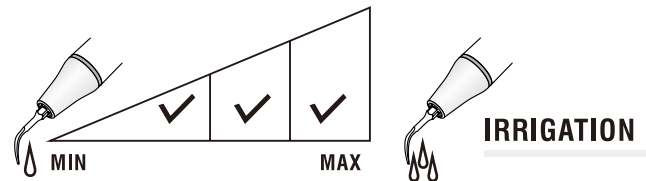

MODE OF ULTRASURGERY AND OTHER SPECIAL TIPS

	Tip Model	Compatible Brand
Scaling	GS1/GS2/GS3/GS4/GS5/GS6/GS7/GS8	Compatible with Sirona Scalers
Periodontics	PS1/PS3/PS3D/PS4	
Endodontics	ES1/ES2/ES3/ES3D/ES4/ES4D/ES5/ES5D/ PS4D/ES8/ES10/ES10D/ES11/ES11D/ES14 /ES15	
Scaling	GK1/GK2/GK3/GK4/GK5/GK6/GK7/GK11	Compatible with Kavo Scalers
Endodontics	EK8	
Scaling	GC1/GC2	
Periodontics	PC1	
Scaling	A1/A2	Compatible with Amdent Scalers
Bone surgery	US1/US1L/US1R/US2/US3/US4/US5/US6/ US13/US21/US25/	Compatible with WOODPECKER & Mectron Ultrasurgery
Sinus lifting	UL1/UL2/UL3/UL4/UL5/UL8	
Endodontics	UE1/UE2/UE3/UE4	
Exelcymosis	UC1/UC2/UC3/UC6/UC7	
Implantation	UI1/UI2/UI7/UI8/UI9	
Periodontal surgery	UP1/UP2/UP3/UP4/UP5/UP6/UP7	



www.glwoodpecker.com



Guilin Woodpecker Medical Instrument Co., Ltd.
Information Industrial Park, Guilin National High-Tech
Zone, Guilin, Guangxi, 541004 P. R. China

Tel:

Europe Sales Dept.: +86-773-5873196, +86-773-2125222

North America, South America &

Oceania Sales Dept.: +86-773-5873198, +86-773-2125123

Asia & Africa Sales Dept.: +86-773-5855350, +86-773-2125896

Fax: +86-773-5822450

E-mail: woodpecker@glwoodpecker.com, sales@glwoodpecker.com

Website: <http://www.glwoodpecker.com>



MedNet GmbH
Borkstrasse 10 · 48163 Muenster · Germany



ZMN/WI-09-036 1. 4-20170401