

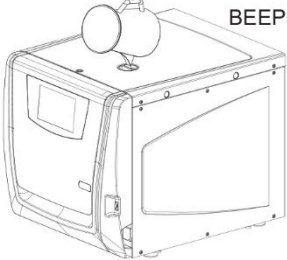

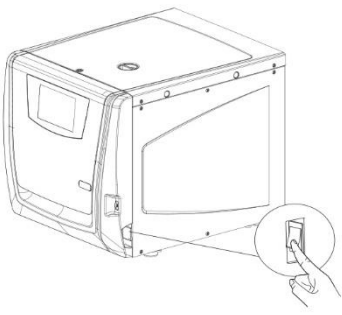



<p style="text-align: center;">1</p>  <p style="text-align: center;">BEEP</p> 	<p style="text-align: center;">2</p> 	<p style="text-align: center;">3</p>  
<p style="text-align: center;">4</p> 	<p style="text-align: center;">5</p> 	<p style="text-align: center;">6</p> 
<p style="text-align: center;">7</p> 	<p style="text-align: center;">8</p> 	<p style="text-align: center;">9</p> <p style="text-align: center;">INTERRUZIONE MANUALE MANUAL STOP</p>   <p style="text-align: right;">x 3 sec.</p> <p style="text-align: right;">x 3 sec.</p>

**MANUTENZIONE ORDINARIA
ORDINARY MAINTENANCE**

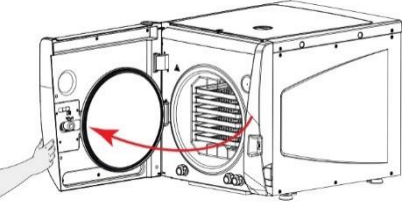
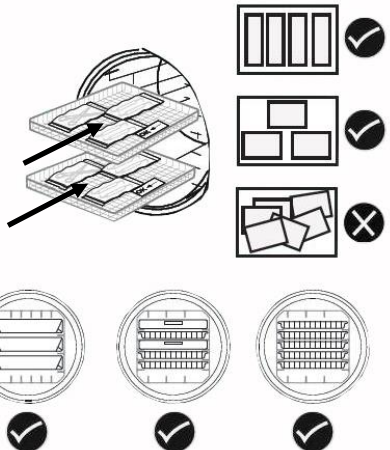
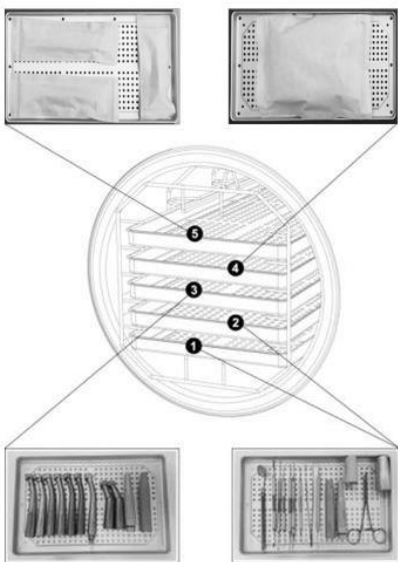
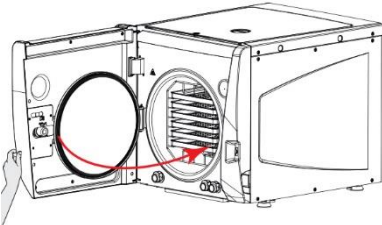
GIORNALIERA

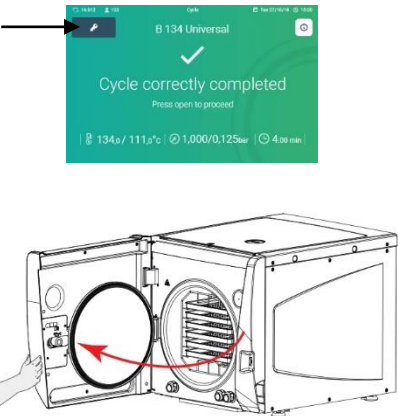
PULIZIA GUARNIZIONE E PARTE INTERNA DELLA PORTA
PULIZIA DELLE SUPERFICI ESTERNE

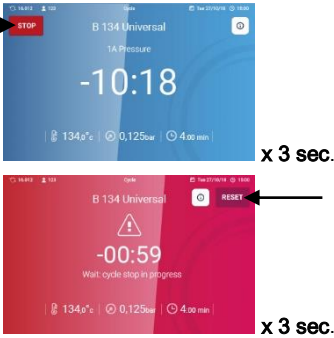
DAILY

CLEANING GASKET AND INTERNAL PART OF THE DOOR
CLEANING THE EXTERNAL SURFACES

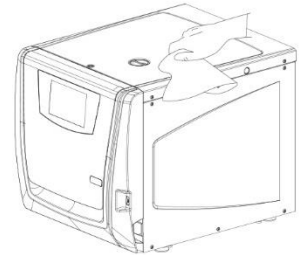
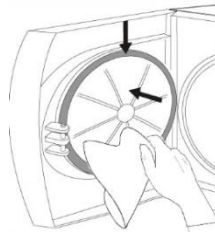

SETTIMANALE

PULIZIA DELLA CAMERA DI
STERILIZZAZIONE E ACCESSORI
DISINFEZIONE DELLE SUPERFICI ESTERNE

WEEKLY

CLEANING THE STERILIZATION CHAMBER
AND ACCESSORIES
DISINFECTION OF EXTERNAL SURFACES

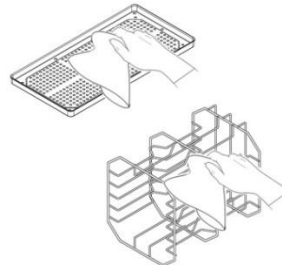
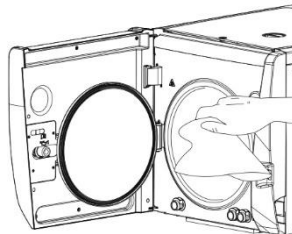

PERIODICA

VEDI MESSAGGI DI MANUTENZIONE PROGRAMMATA

PERIODIC

SEE PROGRAMMED MAINTENANCE MESSAGES

ANNUALE

CONVALIDA DELLA STERILIZZATRICE

ANNUAL

VALIDATION OF THE STERILIZER

**MANUTENZIONE PROGRAMMATA
MANUTENZIONE PROGRAMMATA**

250 CICLI

PULIRE FILTRO CAMERA
LUBRIFICARE VITE PORTA

250 CYCLES

CLEANING CHAMBER FILTER
LUBRICATE DOOR SCREW

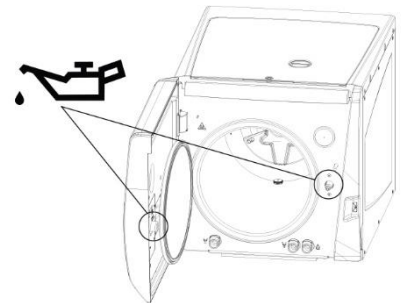
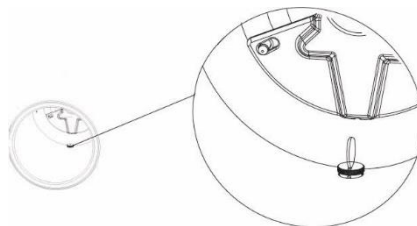

500 CICLI

PULIRE FILTRO ANTIPOLVERE
SOSTITUIRE FILTRO BATTERIOLOGICO
PULIRE SERBATOI ACQUA

500 CYCLES

CLEAN ANTI-DUST FILTER
REPLACE BACTERIOLOGICAL FILTER
CLEAN WATER TANKS

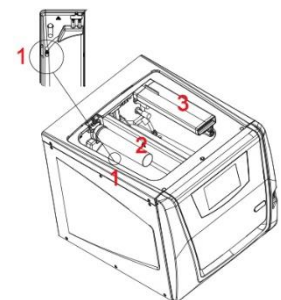
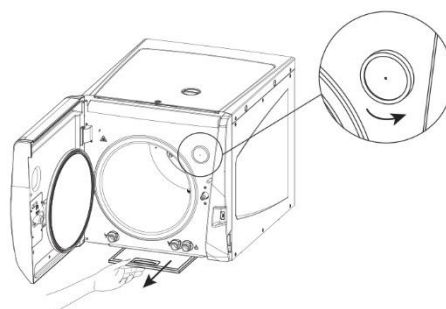

1000 CICLI

SOSTITUIRE GUARNIZIONE PORTA

1000 CYCLES

REPLACE DOOR GASKET

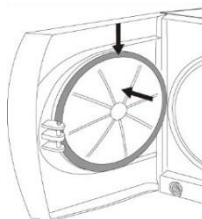

3000 CICLI

MANUTENZIONE PERIODICA
CONTATTARE ASSISTENZA TECNICA

3000 CYCLES

PERIODIC MAINTENANCE
CONTACT TECHNICAL ASSISTANCE

