

GEMINI **EVO**TM

810 + 980 DIODE LASER

USER MANUAL

ULTRADENT PRODUCTS INC



120W PEAK

SOUND

STANDBY

810

ACTIVE

NON SURGICAL

DECONTAMINATION

DEBRIDEMENT

APHTHOUS ULCER

HEMOSTASIS

2.0

AVERAGE WATTS
TIMER IN SECONDS

SURGICAL

INCISION / EXCISION

IMPLANT RECOVERY

TOOTH EXPOSURE

OPERCULECTOMY

GINGIVOPLASTY

GINGIVECTOMY

FRENECTOMY

PULPOTOMY

TROUGHING

AIMING

STANDBY

980

ACTIVE

PAIN RELIEF

7mm



3mm

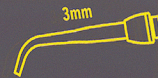

25mm



810

DUAL

980



ACTIVE
STBY



powered by aws



FEDERAL LAW RESTRICTS THIS DEVICE
TO SALE BY OR ON THE ORDER OF A
DENTIST OR PHYSICIAN OR OTHER
LICENSED MEDICAL PRACTITIONER

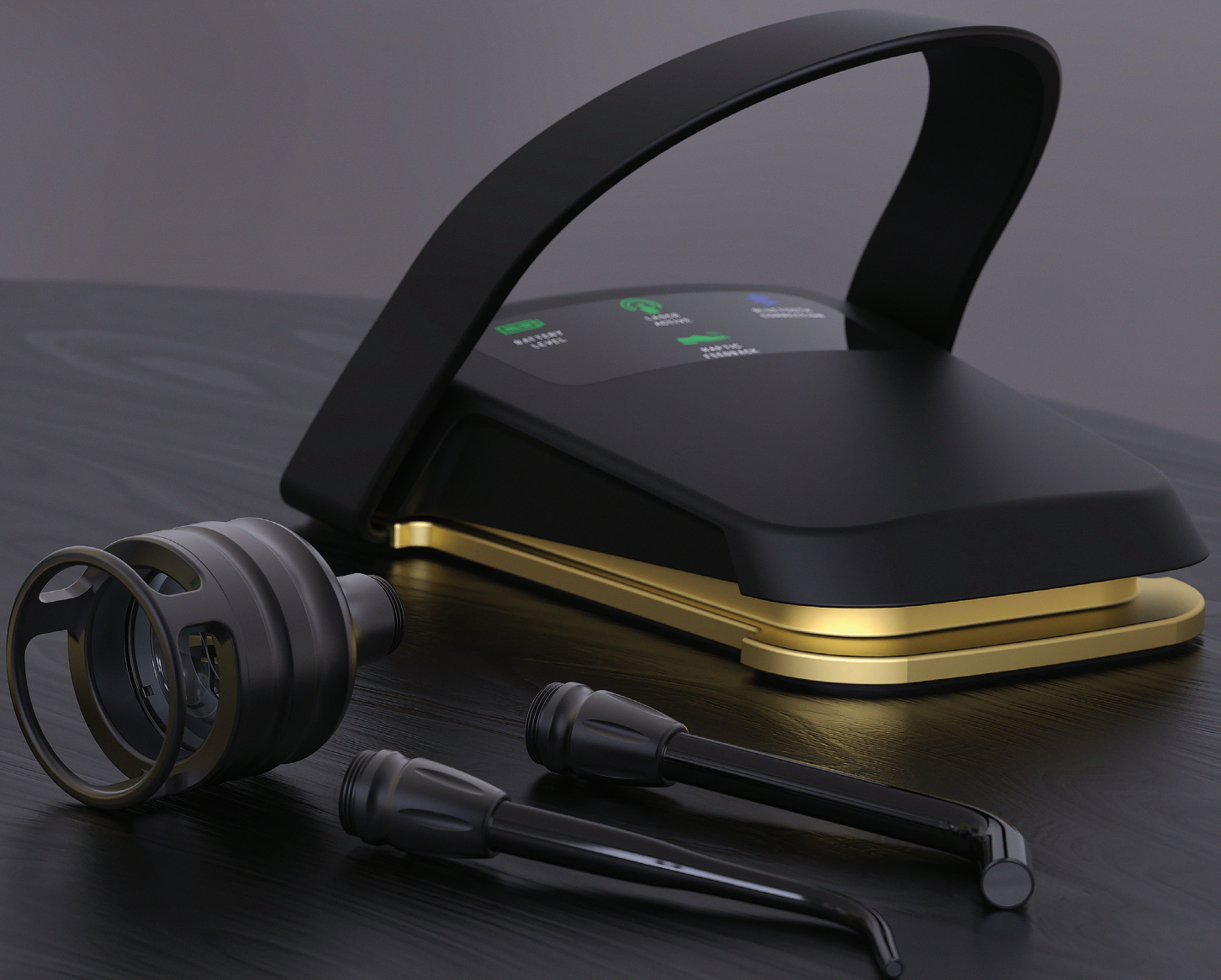

WARNINGS & CAUTIONS

Failure to comply with precautions and warnings described in this User Manual may lead to exposure to dangerous optical radiation sources. Please comply with all safety instructions and warnings.



CAUTION: Read these instructions carefully prior to using your Gemini EVO 810+980 soft tissue diode laser.



CAUTION: Ensure that all users are properly trained prior to use. Consult your distributor for training recommendations. Mandatory training on the Gemini EVO laser is done via this manual.



CAUTION: Do not modify this equipment without authorization of the manufacturer.

CAUTION: Laser fume and/or plume may contain viable tissue particles.



CAUTION: Always wind the fiber optic cable in a clockwise manner around the fiber wrap to avoid fiber breakage. (See Page 33).



CAUTION: Do not use in the presence of combustible or combustion supporting gases.

CAUTION: Always test activate the device outside the mouth before using on a patient.



CAUTION: This unit has been designed and tested to meet the requirements of electromagnetic, electrostatic, and radio frequency interference standards. However, the possibility of electromagnetic or other interference may still exist. Relocating the device may help to eliminate the interference.



CAUTION: Medical electrical equipment needs special precautions regarding electromagnetic compatibility (EMC) and needs to be installed and put into service according to the EMC information provided in pages 60-64 of this manual.



CAUTION: Periodically inspect laser eyewear for pitting and cracking.

CAUTION: In the event abnormal performance is observed, discontinue use and follow instructions in the service and troubleshooting section of this manual.

Safety is paramount when using any energy-based surgical instrument and your office should implement a safety program for the Gemini EVO 810+980 soft tissue diode laser. If your office does not already have a safety officer, one should be appointed to be responsible for understanding proper use, safe operation, and maintenance of the Gemini EVO laser system. Their duties should include training office personnel in all aspects of system safety and management of the Gemini EVO laser and all accessories. / ADDITIONAL TROUBLESHOOTING: For additional troubleshooting questions and tips call 1.801.553.4574. To check for the latest software updates, download the Gemini EVO App in the iOS or Android web store.

WARNINGS & CAUTIONS



WARNING: Visible and Invisible Laser Radiation – Avoid eye or skin exposure to direct or scattered radiation.
Class IV Laser Product



WARNING: Laser Safety Eye Protection **MUST BE WORN** by the Operator, Patient, Assistant, and anyone present when the laser is activated. Eye Protection must conform to Specification DIN EN207 Annex II of the Directive 89/686/EEC with wavelength protection of 810 nm-980 nm, and ± 10 nm of OD 5+.



WARNING: Never direct or point the beam at a person's eyes.



WARNING: Do not look directly into the beam or at specular reflections.



WARNING: Do not aim the laser at metallic or reflective surfaces, such as surgical instruments or dental mirrors. If aimed directly at these surfaces the laser beam will reflect and create a potential hazard.



WARNING: Never operate the laser without a fiber tip attached.



WARNING: Laser aperture at the end of the handpiece.
WARNING: Laser aperture warning label affixed to system handpiece.



WARNING: Always place the system into STBY mode when leaving the Gemini EVO 810+980 soft tissue laser unattended for a few minutes or between patients.



WARNING: Use of controls or adjustments or performance of procedures other than those specified herein may result in hazardous radiation exposure.



WARNING: Do not open unit housing at any time. Danger from optical radiation may exist.



WARNING: The use of accessories, other than those specified, except those supplied or sold by Ultradent Products, Inc., as replacement parts for internal or external components, may result in increased EMISSIONS or decreased IMMUNITY of the Gemini EVO 810+980 soft tissue laser. Refer to pages 60-64 for additional information.

WHAT IS IN THE BOX

The Gemini EVO 810+980 soft tissue laser includes the following.

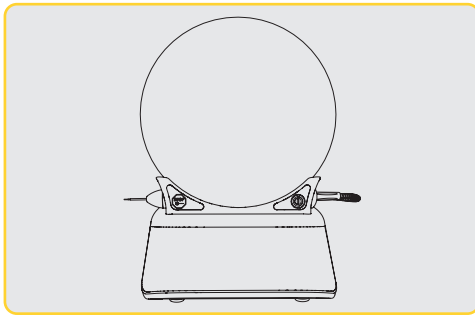

Laser Unit

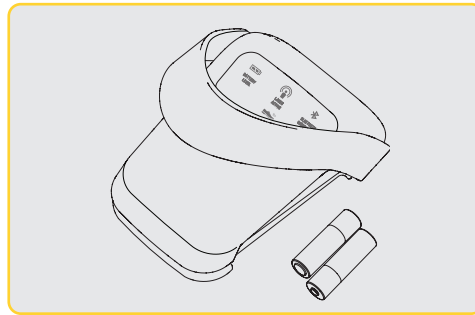

Activation Pedal with 2 AA Batteries

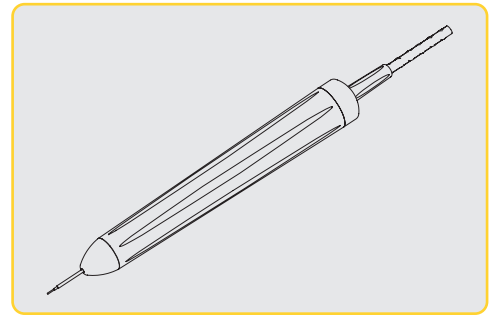

Fiber Delivery System

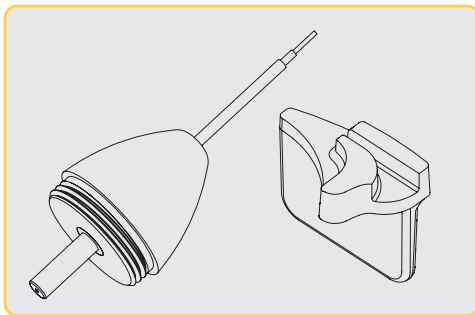

Pre-Initiated Disposable Tips (10)
Bending tool included in the tip box

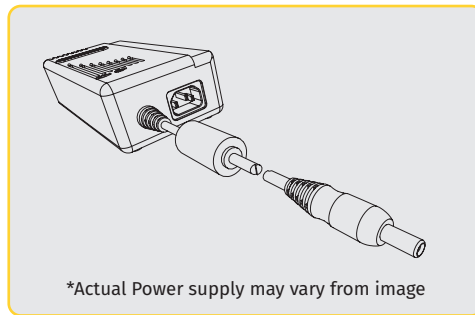

*Actual Power supply may vary from image

*DC Power Supply

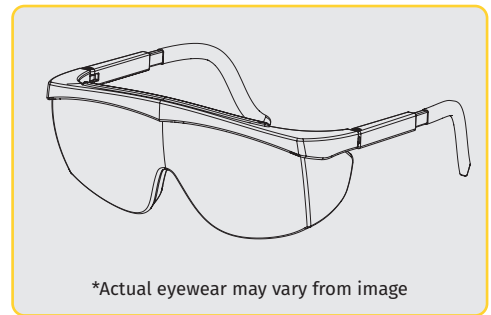

*Actual eyewear may vary from image

*Protective Eyewear (x3)

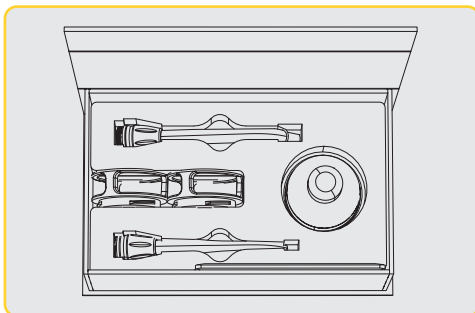

3 mm, 7 mm, and 25 mm PBM adapters

NOTE: The laser ships with the lithium ion battery and fiber delivery system already installed

NOTE: Use proper care when transporting the unit

ALSO INCLUDED: Laser Warning Sign, Laser Training Card Information and User's Manual.
Please note, Warranty Information is included in back of the User's Manual

WARNING: No modification of this equipment is allowed

UNPACKING INSTRUCTIONS

A manufacturer or dealer representative can provide assistance when you are ready to remove the laser from its shipping container. Please do not attempt to unpack the Gemini EVO 810+980 soft tissue laser or install the system without reading this manual first. If you are unsure about any aspect of the assembly, call your customer service representative or dealer for assistance.

SHIPPING CONTAINER INFORMATION

The shipping container you received with your Gemini EVO 810+980 soft tissue laser was specially designed to safely transport the device. In the unlikely event that you need to return the laser for service or repair, please retain the original shipping container.

TABLE OF CONTENTS

Overview

Display	08
Guided Touch Interface "GTI"	09
Laser Unit	10
Activation Pedal	11
Fiber Delivery System	12
Quick Start	13

Controls, Operation & Use

01 - Electronic Key Passcode	14
02 - Selecting a Wavelength	15
03 - Activation Pedal Connection	16
04 - Manual Power Adjustment	17
05 - Laser STBY and Active Modes	18
06 - Preset Procedure Settings and Customization	19-21
07 - Tip Illumination	22
08 - Haptic Sense "HS" - Activation Pedal and PBM adjustments	22
09 - Sound	23
10 - Aiming Light	23
11 - Photobiomodulation (PBM)	24-29
12 - Disposable Tip Operation	30-31
13 - Battery and Battery Level Indications	32
14 - Power Supply	32
15 - Fiber Wrapping	33
16 - Handpiece Magnet	34
17 - Operating Mode	34
18 - Emergency Stop	35
19 - Remote Interlock	35
20 - Adding New Activation Pedal and Pairing	36
21 - Transparent Electroluminescent Display	37
22 - Wi-Fi Connectivity and Dashboard	38-45

Cleaning and Sterilization Procedures	46-48
Procedural Recommendations	49
Facility & Environmental Considerations	50
General Safety Considerations	51-53
System Specifications	54
Service and Troubleshooting	55-58
Cybersecurity	59
Electromagnetic Environment Guidance	60-64
Labeling	65-67
Warranty	68

OVERVIEW - DISPLAY

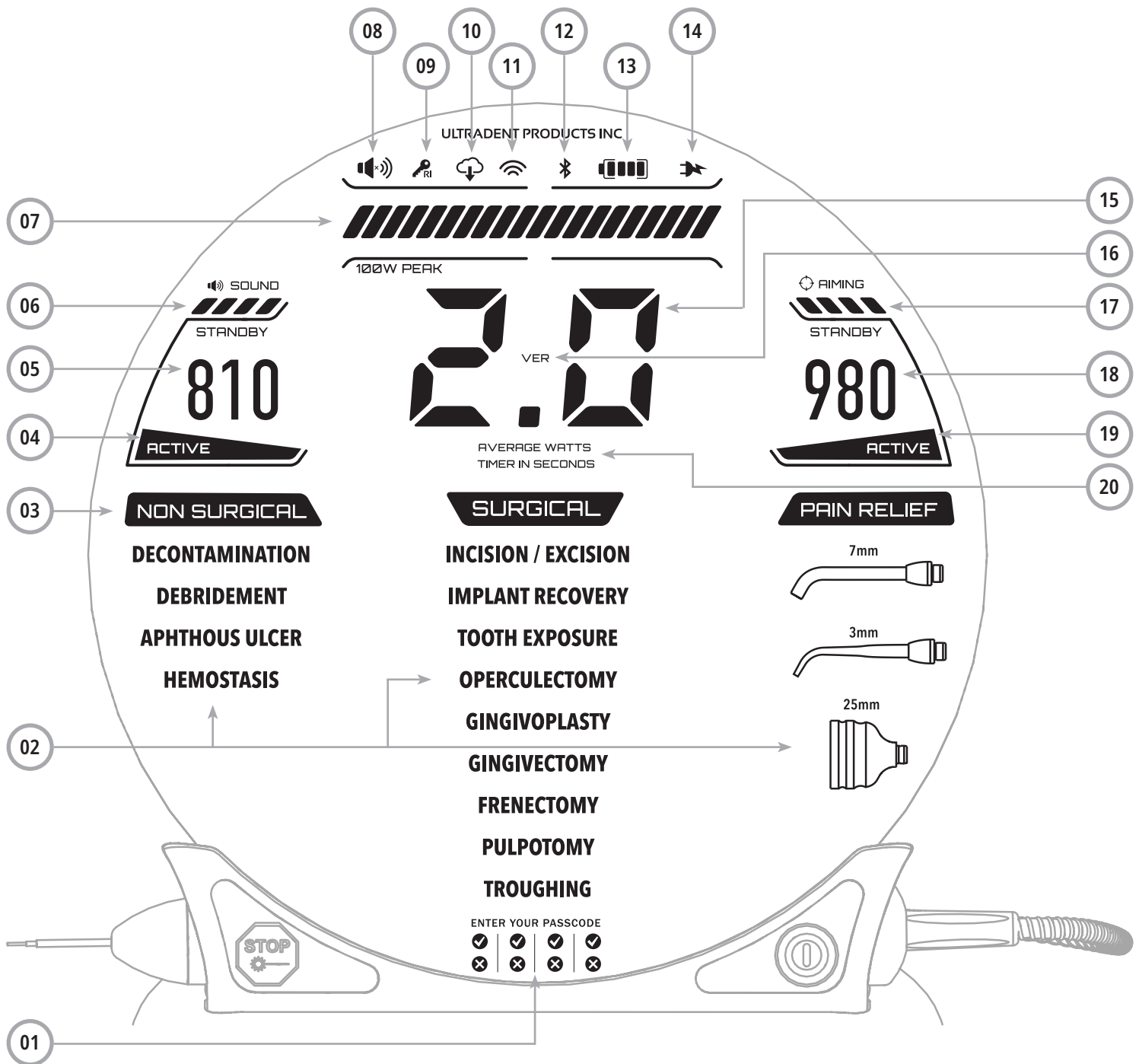

- 01 - ELECTRONIC PASSCODE
- 02 - PRESET PROCEDURES
- 03 - PRESET CATEGORIES
- 04 - 810 ACTIVE/STBY
- 05 - 810 WAVELENGTH
- 06 - SOUND LEVEL
- 07 - POWER BAR

- 08 - VOLUME INDICATION
- 09 - REMOTE INTERLOCK
- 10 - SOFTWARE UPDATE
- 11 - WI-FI STRENGTH
- 12 - BLUETOOTH
- 13 - BATTERY
- 14 - POWER SUPPLY

- 15 - POWER INDICATOR
- 16 - SOFTWARE VERSION
- 17 - AIMING LIGHT LEVEL
- 18 - 980 WAVELENGTH
- 19 - 980 ACTIVE/STBY
- 20 - VALUE TYPE INDICATOR

OVERVIEW - GUIDED TOUCH INTERFACE "GTI"

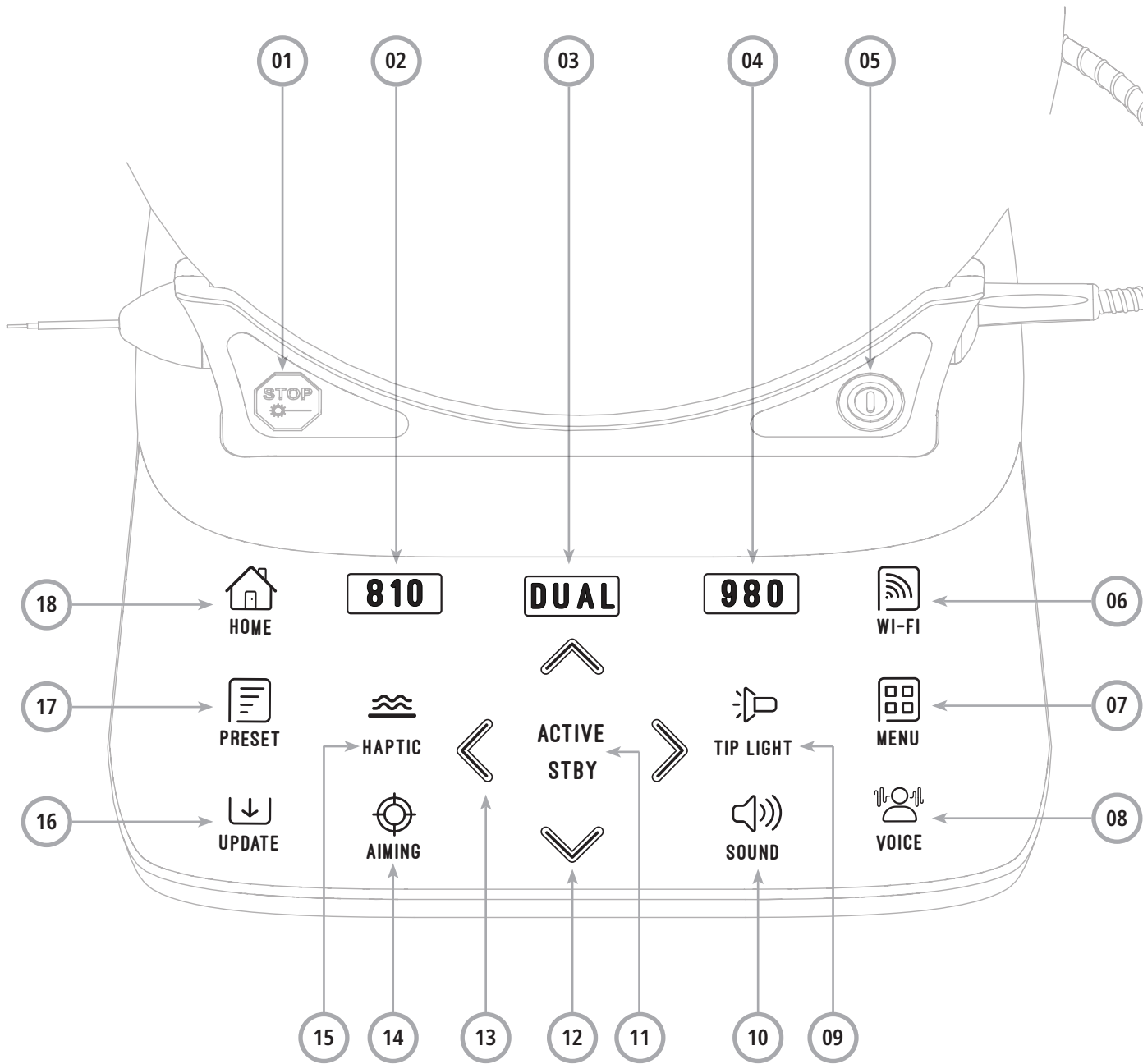

01 - EMERGENCY STOP
 02 - 810 WAVELENGTH
 03 - DUAL WAVELENGTH
 04 - 980 WAVELENGTH
 05 - ON/OFF
 06 - WI-FI INDICATOR
 07 - MENU SELECTION

08 - VOICE CONFIRMATION
 09 - TIP ILLUMINATION
 10 - SOUND
 11 - ACTIVE/STBY
 12 - UP/DOWN ARROWS
 13 - LEFT/RIGHT ARROWS
 14 - AIMING LIGHT

15 - HAPTIC SENSE
 16 - AVAILABLE UPDATES
 17 - PRESET PROCEDURES
 18 - HOME

OVERVIEW - LASER UNIT

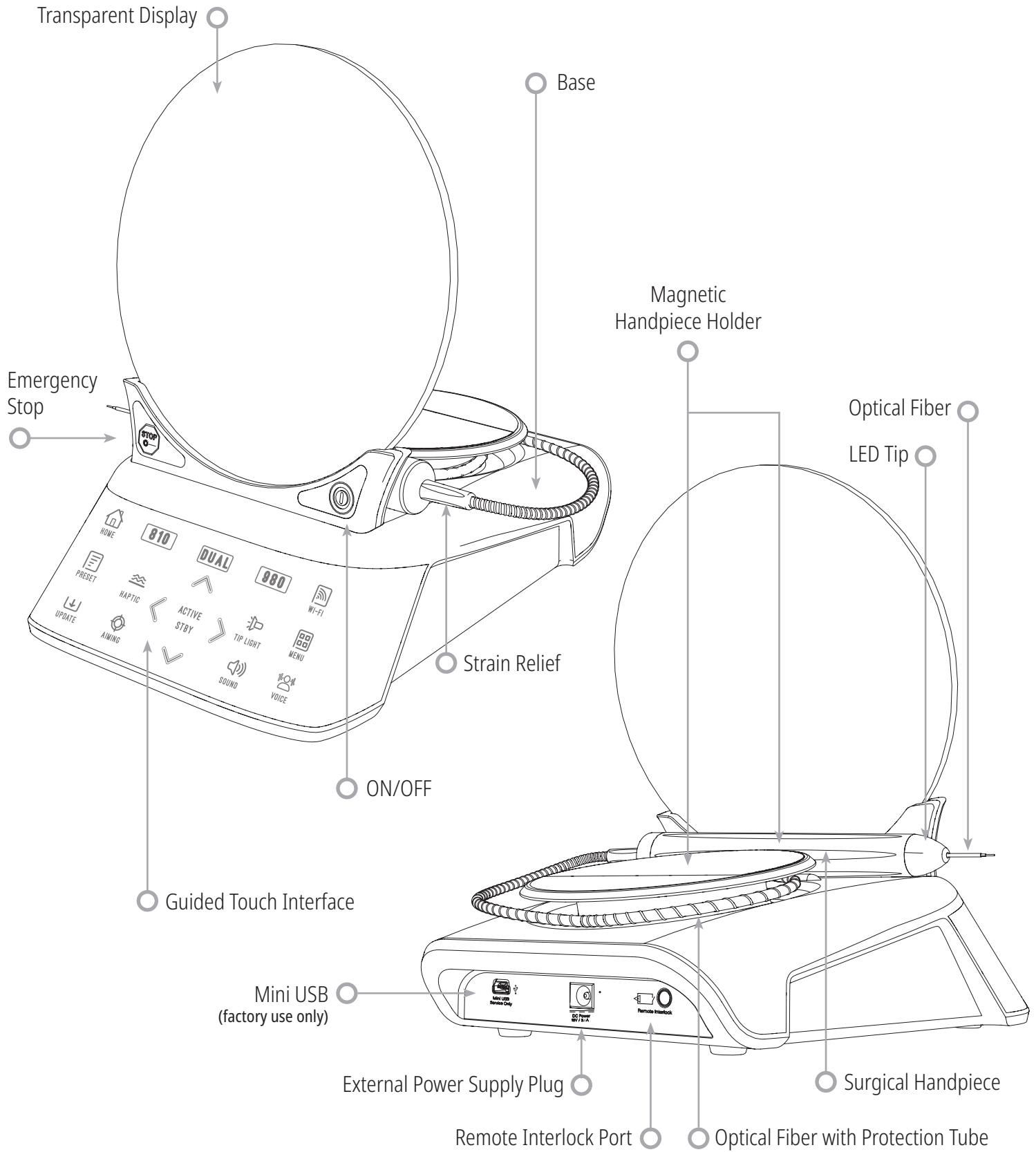

OVERVIEW - ACTIVATION PEDAL

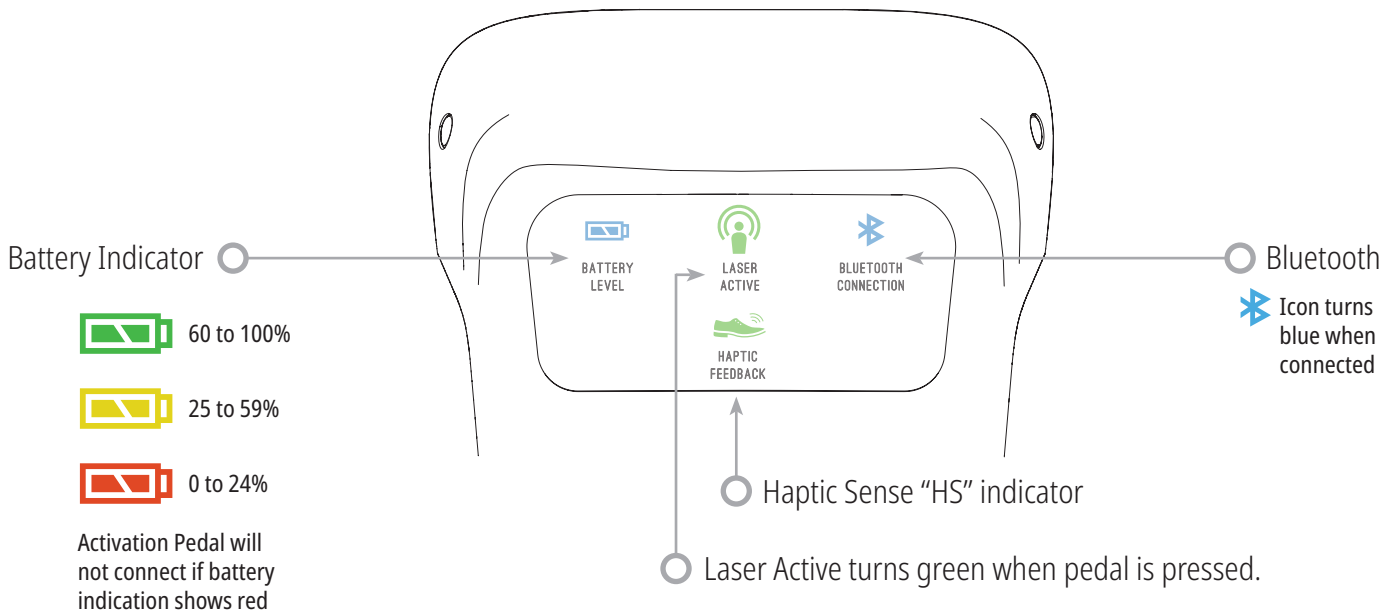
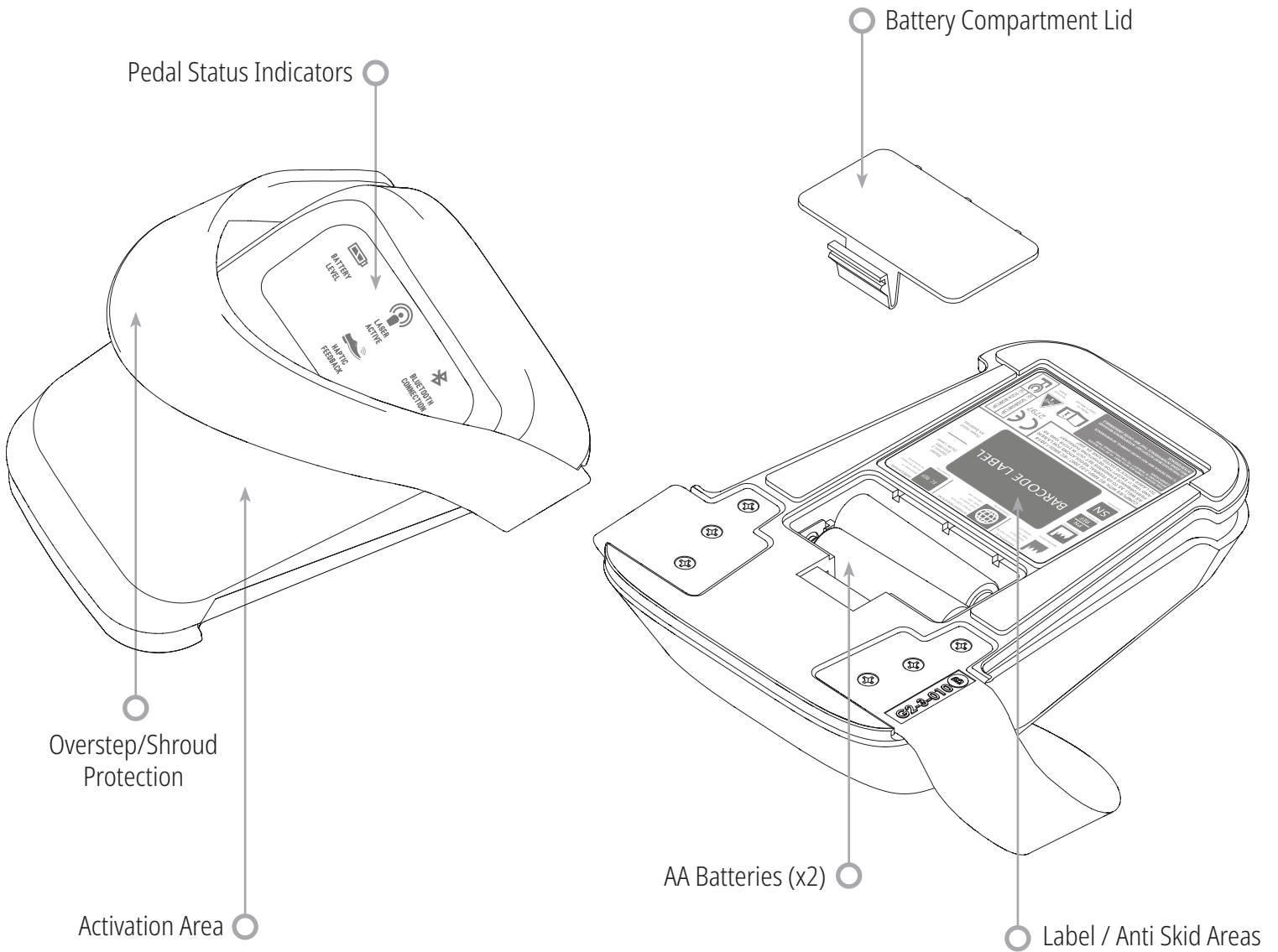

OVERVIEW - FIBER DELIVERY SYSTEM

The Fiber Delivery System is a unique and ergonomic optical cable that is non-detachable from the Laser Unit. The handpiece will require cleaning and sterilization after each patient treatment. Disposable tips are intended for single-use only and must be disposed of after each patient use.

Refer to pages 46-48 for cleaning and sterilization procedures.

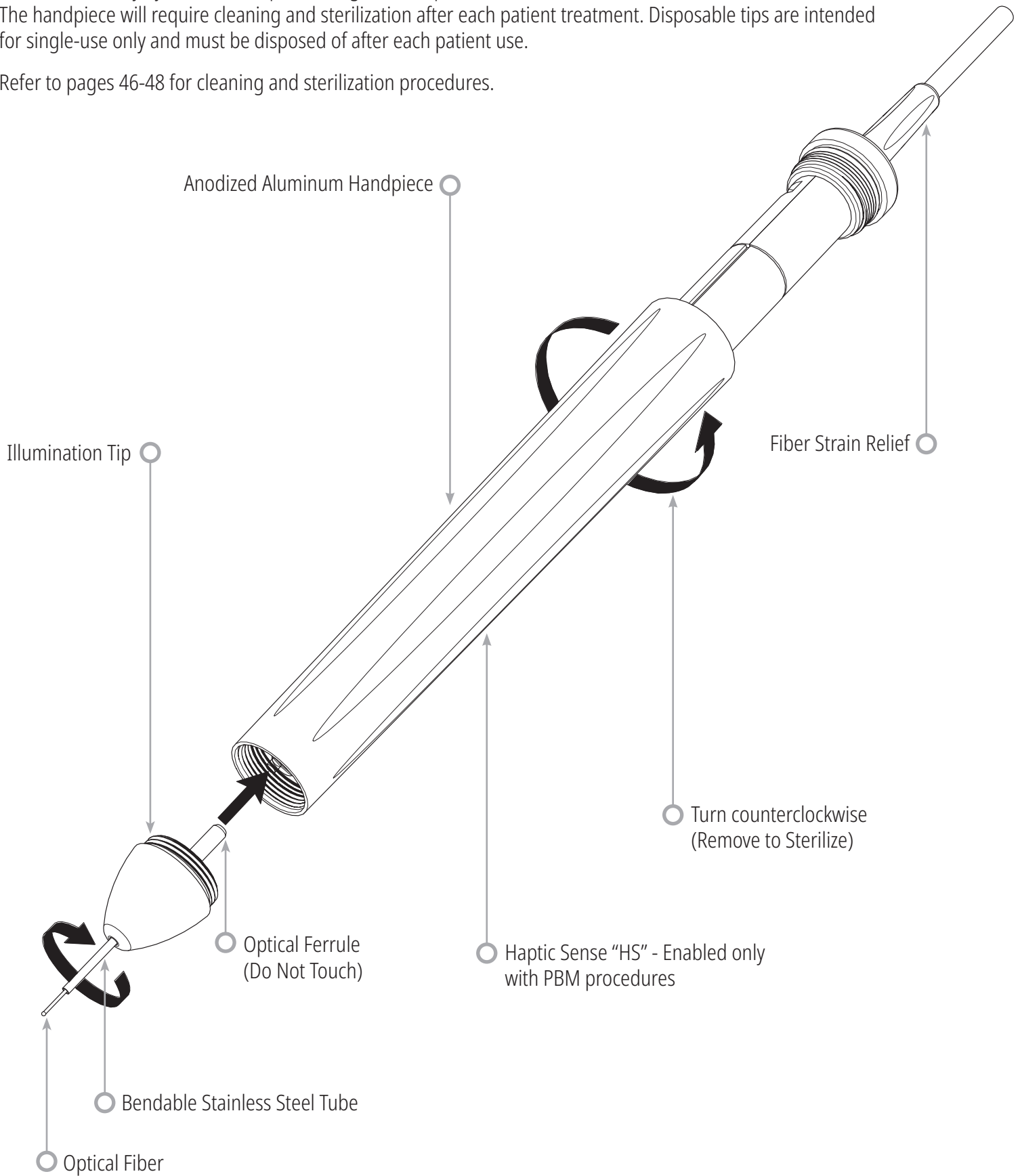

QUICK START



1. Download the mobile App

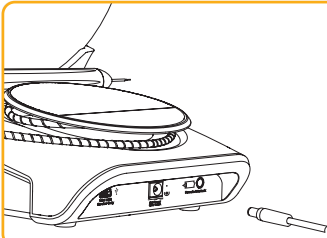
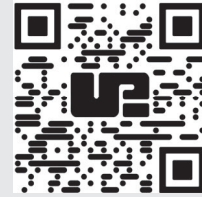

2. Plug In Power Supply
During initial setup use the AC/DC power supply for at least one hour to fully charge the battery. Plug the power supply into an AC outlet and connect to the corresponding connector on the rear of the system.

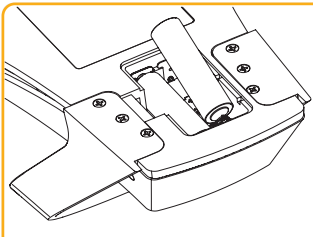

3. Insert AA Batteries into Activation Pedal
Install the (2) provided AA batteries into the wireless activation pedal. When replacing the AA batteries, we recommend an ALKALINE type battery.

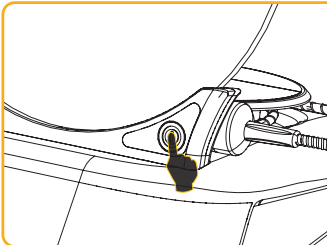

4. Turn Laser Unit ON
The Universal ON/OFF button is a membrane switch which requires pressure "click" in order to be activated.

ENTER YOUR PASSCODE



5. Enter Electronic Key Passcode
Enter the electronic key passcode on the Guided Touch Interface using the Up and Down arrow keys. The security code sequence is **UP, DOWN, UP, DOWN**. A checkmark icon will appear when the correct key is input.

810 DUAL 980

6. Select Your Desired Wavelength
Select the desired laser wavelength on the Guided Touch Interface:
810 nm, Dual or 980 nm Wavelength.

🔊 "Please select wavelength"

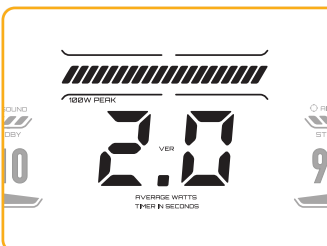

7. Select Your Desired Power Setting
Select your desired power setting, then activate the laser. (Pages 17-21)

01 - ELECTRONIC KEY PASSCODE

The Gemini EVO 810+980 soft tissue laser is equipped with an electronic key passcode. When you turn the Laser Unit on, the passcode key screen will be displayed at the bottom center of the screen. The correct passcode sequence should be entered on the Guided Touch Interface:

UP, DOWN, UP, DOWN

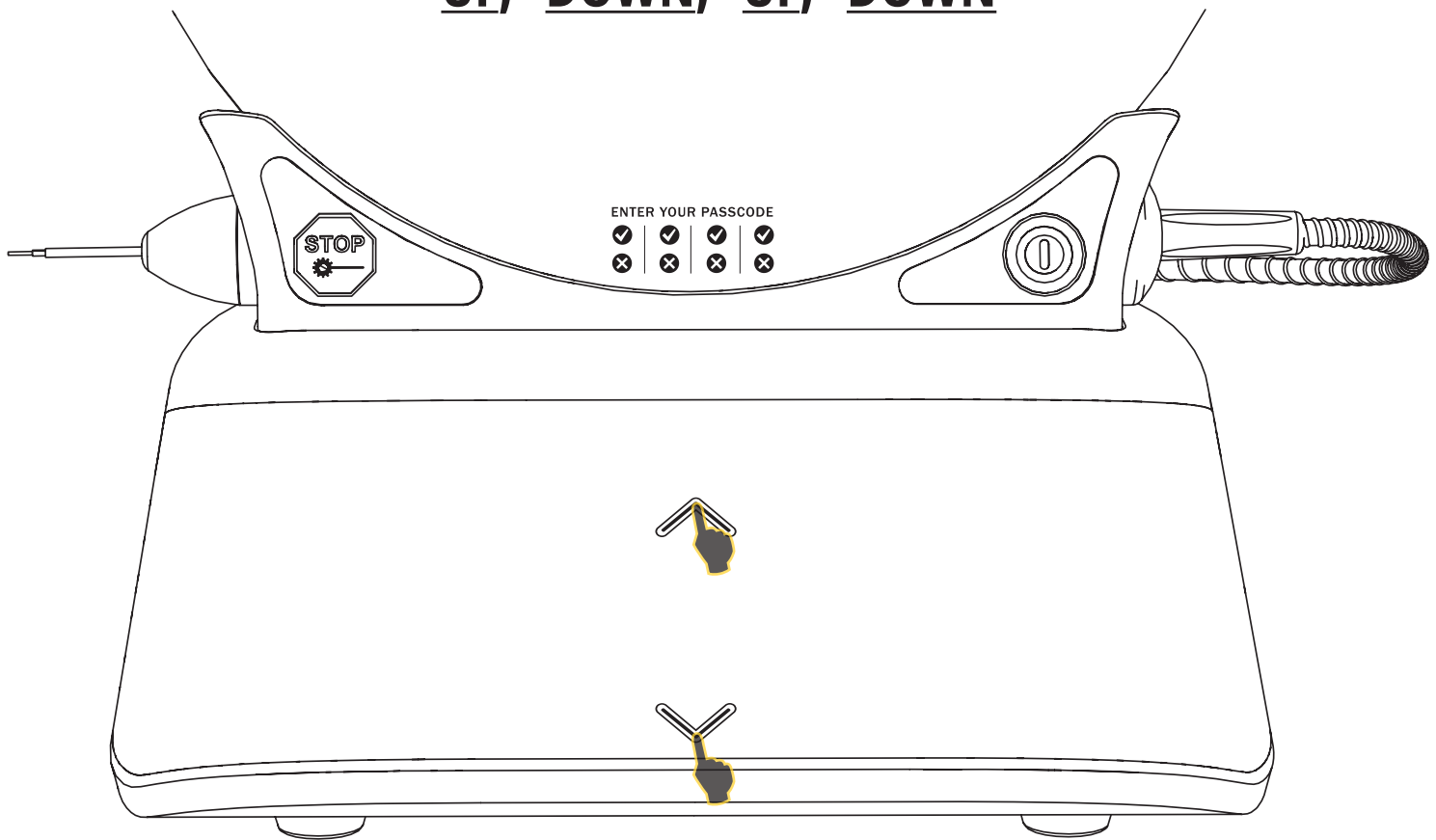

The Gemini EVO 810+980 soft tissue laser is equipped with Guided Touch Interface "GTI" which means only the icons that are relevant for a given procedure will be shown. When entering the electronic key passcode, only the UP and DOWN arrows will be shown as they are the only necessary icons to be touched while entering the passcode.

**THE GUIDED TOUCH INTERFACE AREA REQUIRES
AN EXTREMELY LIGHT TOUCH TO WORK EFFECTIVELY.**

**THE LIGHTER THE FINGER PRESSURE,
THE MORE LIKELY IT WILL SENSE THE TOUCH**

02 - SELECTING A WAVELENGTH

When the system is turned on, and the electronic passcode is properly input (Page 14), you will be prompted with voice confirmation "Please select wavelength" and two flashing wavelength graphics to select the desired wavelength of choice. The Gemini EVO 810+980 soft tissue laser can operate in three wavelength modes: 810 nm alone, 980 nm alone, or Dual Wavelength. A wavelength mode must be selected before proceeding further, but may be changed at any time.

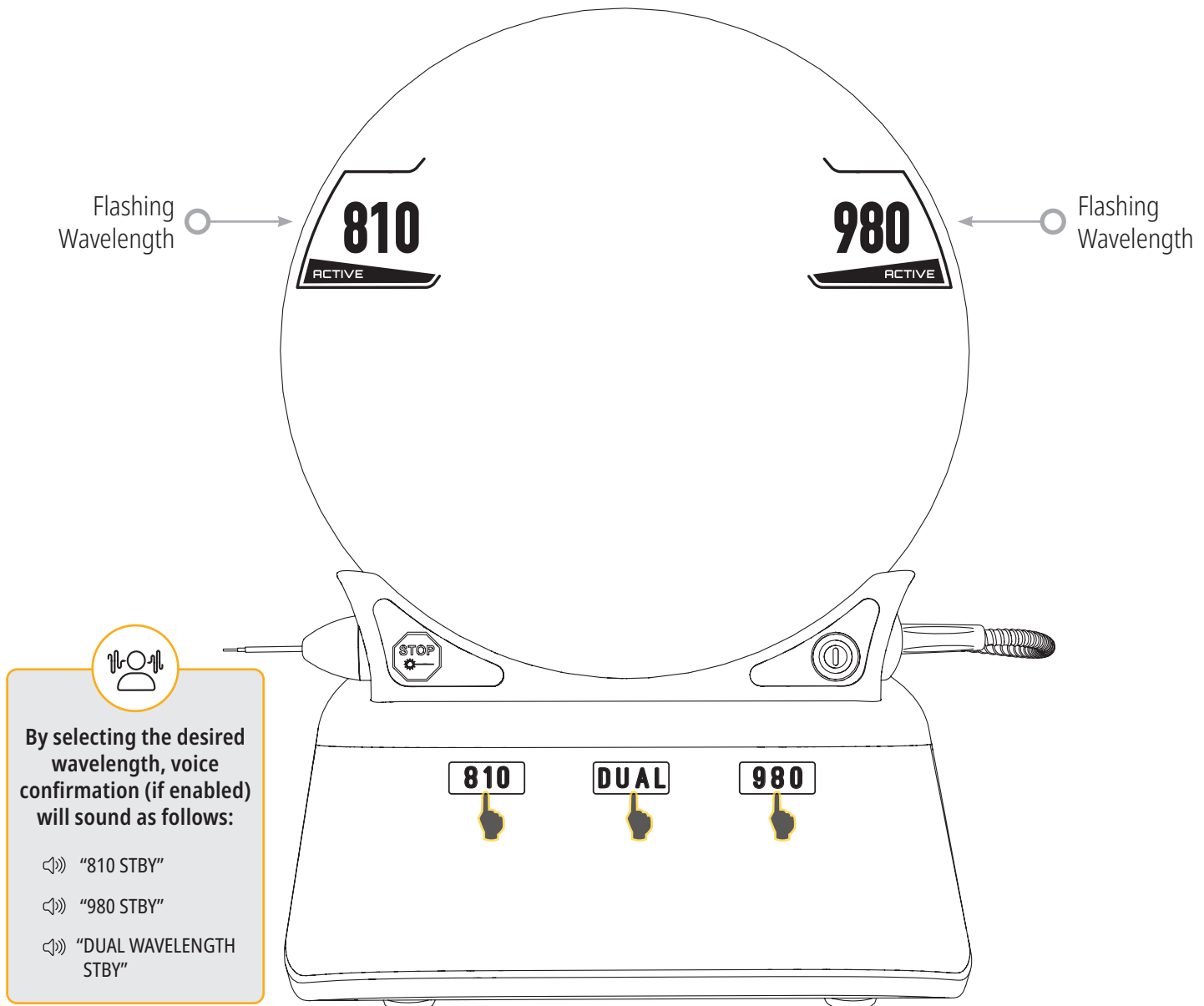

When selecting a wavelength, the 3 wavelength options 810 / DUAL / 980 will be shown as they are the only necessary icons to be touched while selecting a wavelength.

CONTROLS, OPERATION & USE

03 - ACTIVATION PEDAL CONNECTION

Connecting the Activation Pedal with your Laser Unit via Bluetooth for the first time is simple.

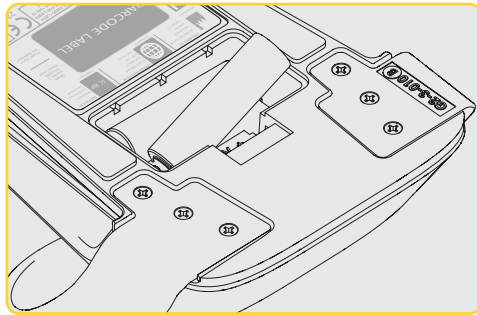

Install the provided 2 AA batteries

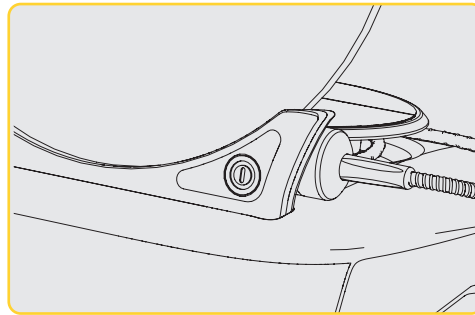

Turn the laser unit ON



Enter the Passcode

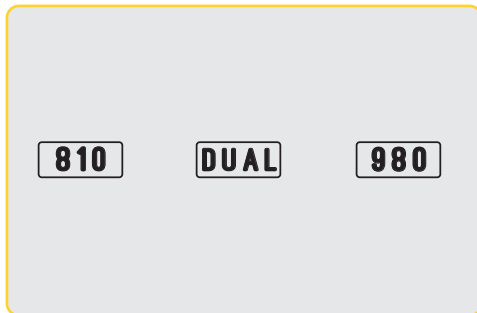

Select the wavelength of choice



Press Active to initiate the Bluetooth connection between the laser unit and pedal



Depress and release the Activation Pedal once. Connection is done automatically.

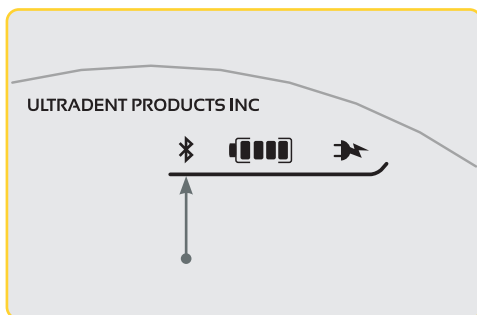

A Bluetooth indicator will appear on the display and Activation Pedal when it is properly connected and the Laser is in Active mode.

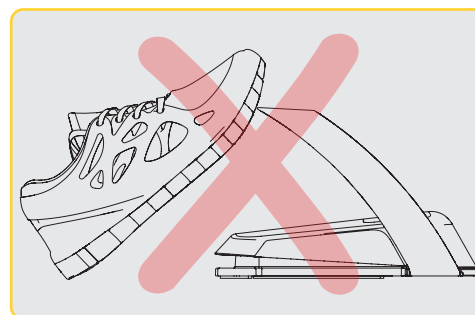

The Activation Pedal comes with a protective shroud to prevent accidental laser activation. Please do not step on the protective shroud as it could result in accidental damage to the Activation Pedal.

PAIRING A NEW ACTIVATION PEDAL

Follow the instructions on Page 36 to add a new activation pedal to an existing Gemini EVO device.

04 - MANUAL POWER ADJUSTMENT

The Gemini EVO 810+980 soft tissue laser can output up to a maximum of 2.0 watts of average power. To adjust the power setting manually, touch the **LEFT** and **RIGHT** arrows on the Guided Touch Interface. Each touch of an arrow raises or lowers the power by 0.1 watts. Touching and holding an arrow will increase the speed in which the power setting is raised or lowered. Touch the ACTIVE button to put the laser in active mode. Depress the activation pedal to initiate the laser.

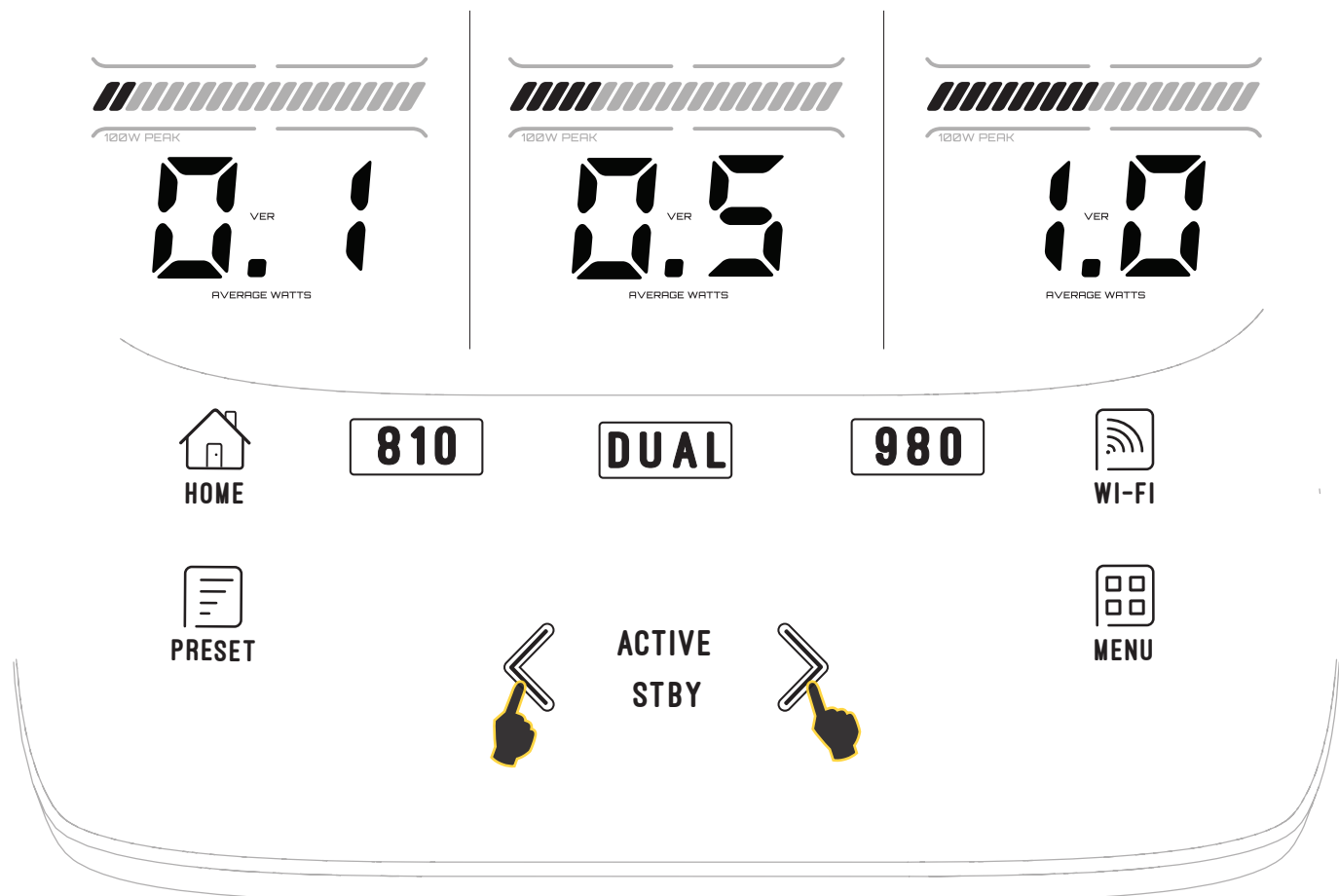

CLINICAL TIP

Optimal results will be achieved by regulating the power and the speed that the operator moves the fiber optic tip. Tissue charring is an undesirable after-effect of too much power or of the fiber tip moving too slowly. Always use the least amount of power that is required to complete your procedure. The ideal tissue response will show little or no discoloration after treatment and will result in less collateral damage and faster healing.

Avoid penetrating or damaging the periosteum, and do not attempt to use the laser on alveolar bone. Because the laser energy is attracted to melanin and hemoglobin, power must be reduced when treating patients with darker pigmented soft tissue.

05 - LASER STBY AND ACTIVE MODES

The Active/STBY Guided Touch Interface selection serves a **dual purpose**. It activates (ACTIVE) and deactivates the laser (STBY). By default, the system powers up in STBY mode. The laser cannot be activated prior to selecting a wavelength. Each time the ACTIVE/STBY selection is touched, the system toggles between Active and STBY modes. There is an audio confirmation (unless voice confirmation is muted), and an icon for either "ACTIVE" or "STANDBY" near each wavelength indicator. The red aiming beam and tip illumination are visible only when the laser is in Active mode.

When the system is in Active mode, touching any selection other than LEFT and RIGHT will return the system to the STBY mode. When the Activation Pedal is depressed in the Active mode, the outer indicator lines around each wavelength icon on the display flashes to provide a visual indication that the laser is firing. There is also an audio beep when laser is being fired. For safety purposes, a laser firing delay of 0.25 seconds was implemented in order to prevent accidental activation.

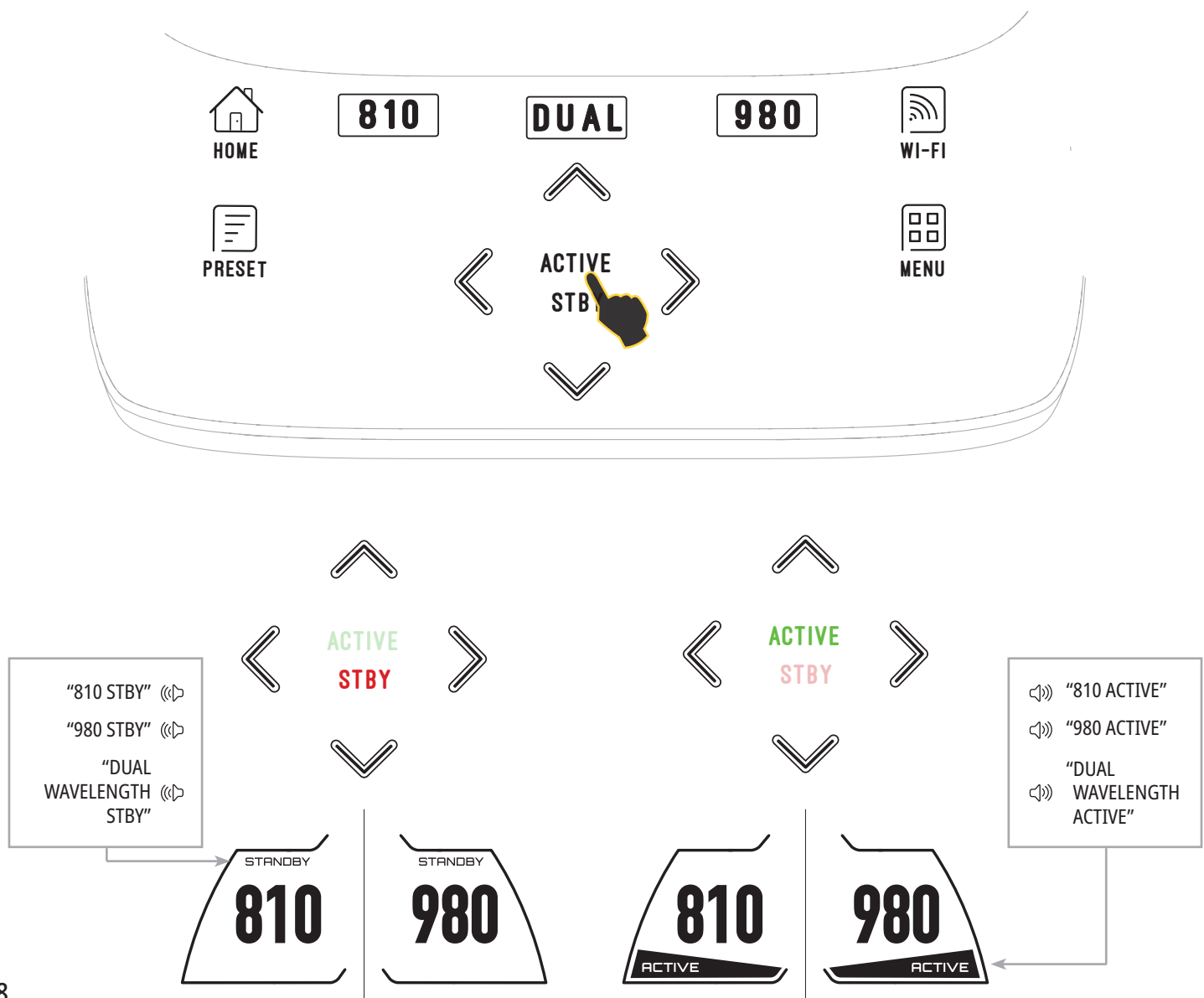

06 - PRESET PROCEDURE SETTINGS AND CUSTOMIZATION

Touch the PRESET selection to bring up all the preset procedures and categories on the display. A collection of pre-programmed procedures will be revealed on the display. Selecting the LEFT and RIGHT arrows will toggle between NON SURGICAL, SURGICAL, and PAIN RELIEF categories. Selecting the UP and DOWN arrows will toggle between procedures within each category. The corresponding power setting for each procedure is displayed on the Power Indicator when the procedure is highlighted.

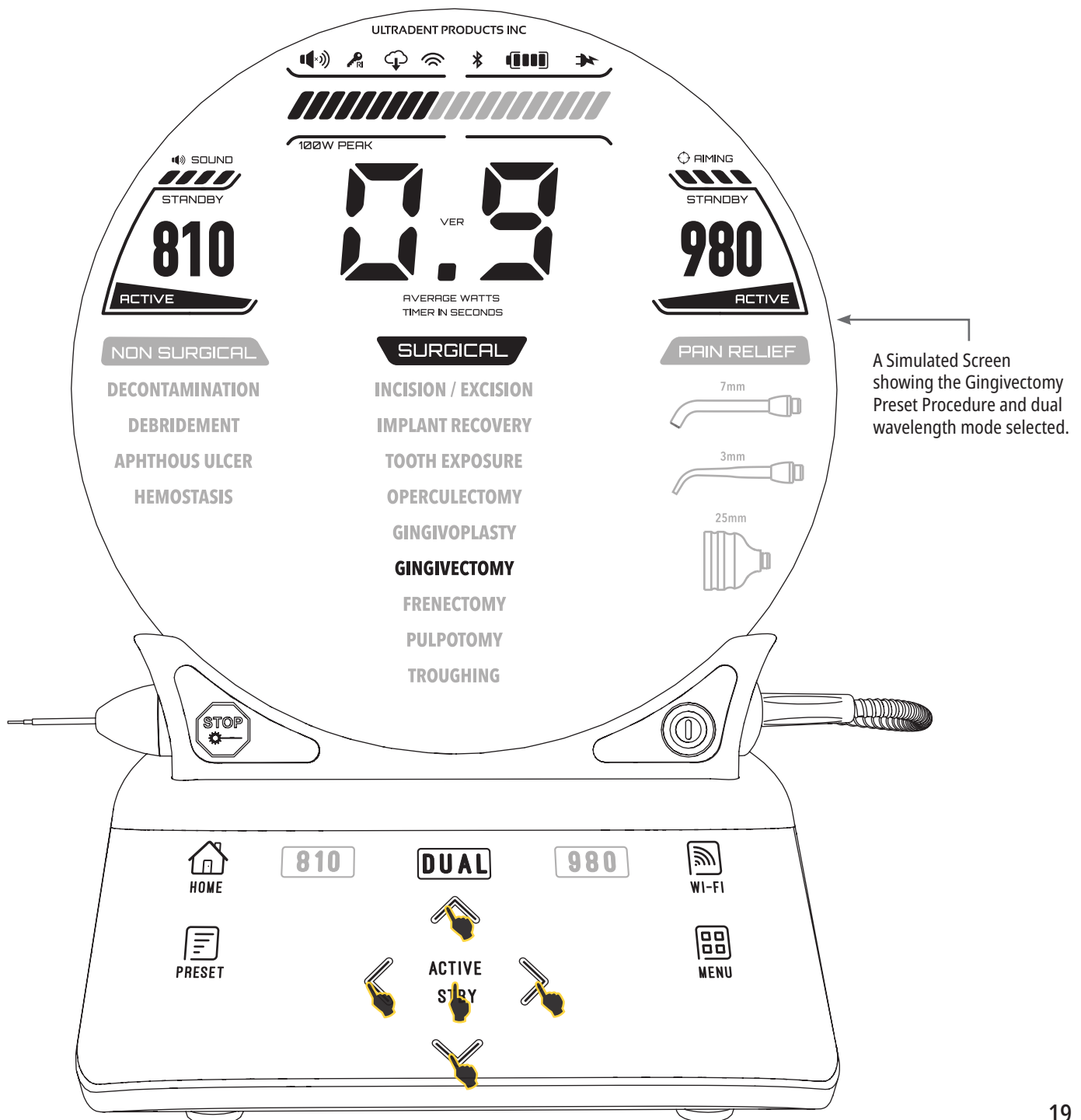

PRESET PROCEDURE SETTINGS AND CUSTOMIZATION

The Gemini EVO 810+980 soft tissue laser is pre-programmed with 16 procedures listed under three categories: NON SURGICAL, SURGICAL, and PAIN RELIEF. Within each category are the most commonly used procedures with suggested power settings. Always use the minimum amount of power necessary to perform a particular procedure. Manual power adjustment may be necessary depending on patient and procedural needs.

NON SURGICAL	Tissue Contact	810	DUAL	980
Decontamination	Yes	0.6w	0.5w	0.6w
Aphthous Ulcer	No	0.7w	0.6w	0.8w
Hemostatis	Yes	0.9w	0.8w	1.0w
Debridement	Yes	0.4w	0.3w	0.5w
SURGICAL	Tissue Contact	810	DUAL	980
Incision / Excision	Yes	1.1w	1.0w	1.2w
Implant Recovery	Yes	1.3w	1.1w	1.5w
Tooth Exposure	Yes	0.8w	0.7w	0.9w
Operculectomy	Yes	1.2w	1.1w	1.4w
Gingivoplasty	Yes	0.8w	0.7w	0.9w
Gingivectomy	Yes	1.0w	0.9w	1.1w
Frenectomy	Yes	1.2w	1.1w	1.4w
Pulpotomy	Yes	0.8w	0.7w	1.0w
Troughing	Yes	0.9w	0.8w	1.0w
PAIN RELIEF	Tissue Contact	810	DUAL	980
7 mm Tip	User choice	0.3w	0.3w	0.3w
3 mm Tip	User choice	0.3w	0.3w	0.3w
25 mm Tip	Spacer	1.0w	1.0w	1.0w

Note: Preset procedure settings are only a general recommendation from the manufacturer. They are not meant to replace the need for proper training or clinical judgment of the operator. The presettings are subject to changes through software updates and may therefore differ slightly from the settings indicated on this page. All power settings are shown in average power.

PRESET PROCEDURE SETTINGS AND CUSTOMIZATION

Gemini EVO 810+980 soft tissue laser preset procedure settings can be customized. To save your own procedure setting, press PRESET once to bring up preset procedures on the display and navigate to the procedure you would like to customize.

When a particular procedure is highlighted, press and hold PRESET ICON for 3 seconds.

You will hear two audible beeps and the power indicator value and power bar will start flashing on the display. Use LEFT/RIGHT arrows to adjust the new average power to the desired setting.

To save the setting, press and hold the PRESET ICON for 3 seconds again. You will hear two audible beeps when the setting has been saved.

To reset all preset procedure settings to the factory default, press and hold the PRESET ICON for 5 seconds. You will hear three audible beeps when the settings are reset.

Another way to customize the preset procedures is through the DASHBOARD. See page 45 for additional instructions.



Hold 3 seconds = Customize / Save
Hold 5 seconds = Factory Reset

07 - TIP ILLUMINATION

The Gemini EVO 810+980 soft tissue laser handpiece is equipped with a tip illumination light to provide better visibility of the surgical site during treatment. To toggle the light intensities between LOW, MEDIUM, HIGH, and OFF, touch the MENU icon and select TIP LIGHT on the Guided Touch Interface. Then use the arrows UP / DOWN to change LED intensities. LED will only stay on for 3 seconds as a preview when not in active mode. Tip Illumination icon shows Green color when this feature is enabled and Red when it is OFF.

Please note arrows UP / DOWN will appear and disappear according to the selected settings. As an example, if you select HIGH, the UP arrow will disappear indicating this is the highest setting available. The same behavior happens when you select OFF, in which the DOWN arrow will disappear.

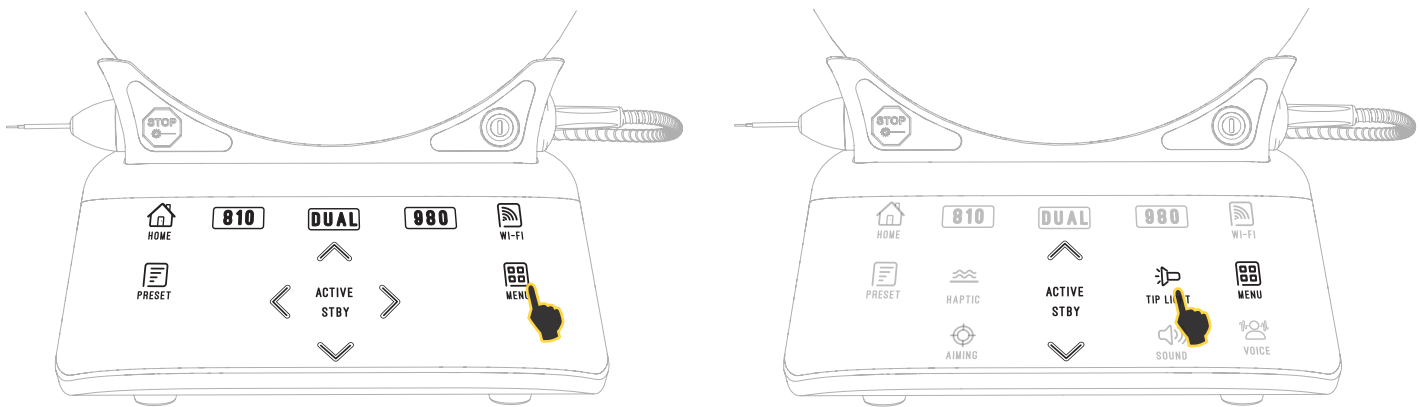

08 - HAPTIC SENSE “HS” - ACTIVATION PEDAL & PBM ADJUSTMENTS

The Gemini EVO 810+980 soft tissue laser is equipped with Haptic Sense “HS” in order to add an additional dimension of feedback while depressing the activation pedal or during PBM procedures. This feature will provide the user a buzzing sensation to the foot or hand while the activation pedal is depressed. To toggle the Haptic Sense “HS” between activation pedal and handpiece (PBM procedures only), press the haptic icon. Blue icon indicates Haptic Sense is available for activation pedal and Amber icon for handpiece (PBM procedures only). To adjust intensities between LOW, MEDIUM, HIGH, and OFF, touch the arrows UP / DOWN to change the intensities.

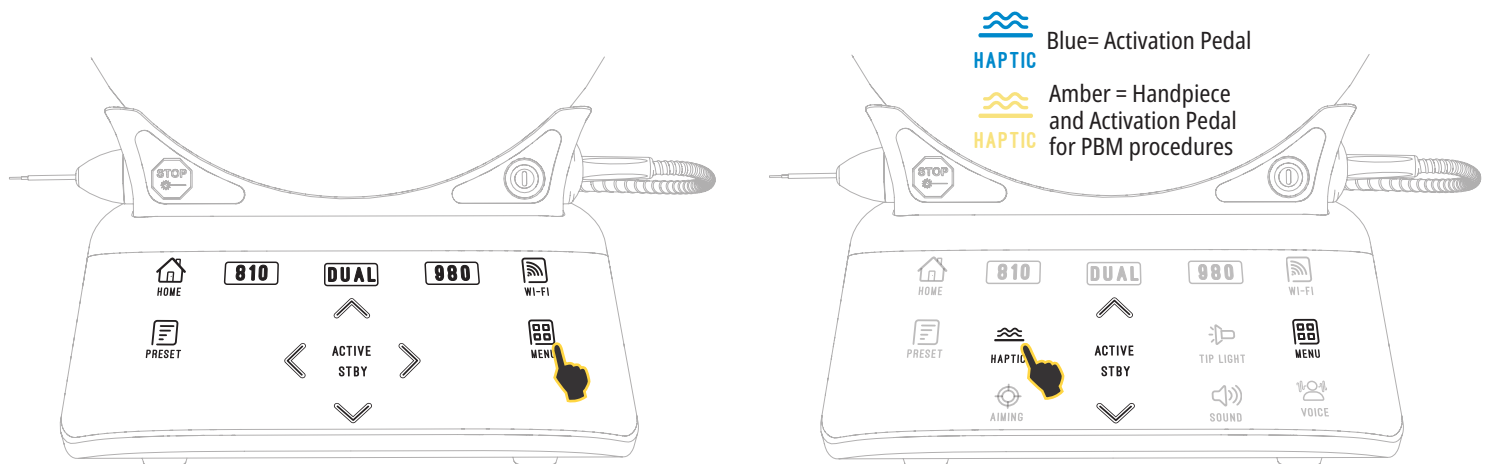

CONTROLS, OPERATION & USE

09- SOUND

To change the sound level, touch the MENU and then the SOUND icon on the Guided Touch Interface. Adjust the sound level by touching the Up / Down arrows. To exit, touch the MENU icon to save your selection. The system remembers the last used sound setting when it is powered on. When UP arrow disappears, this indicates the volume is all the way to max and vice versa. Icon shows Red when OFF.

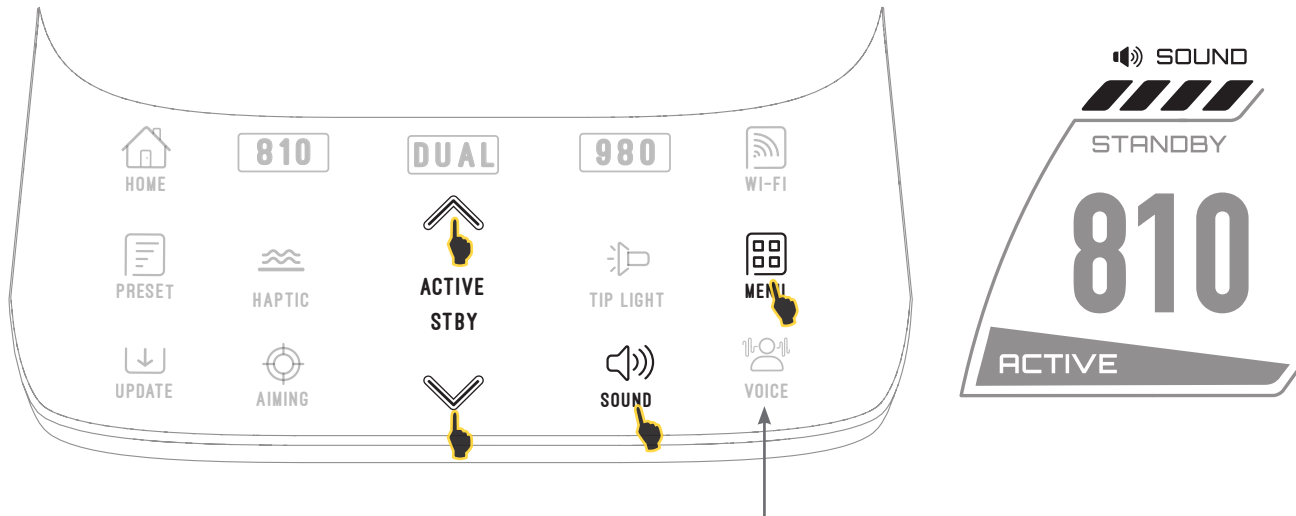

Voice Confirmation can be enabled and disabled by touching the voice confirmation selection on the Guided Touch Interface. Red icon shows disabled and Green enabled.

10 - AIMING LIGHT

To change the aiming light intensity, touch the MENU and then the AIMING icon on the Guided Touch Interface. Adjust the aiming light level by touching the Up / Down arrows. To exit, touch the MENU icon to save your selection. The system remembers the last used sound setting when it is powered on. When UP arrow disappears, this indicates the setting is all the way to max and vice versa. Icon shows Red when OFF.

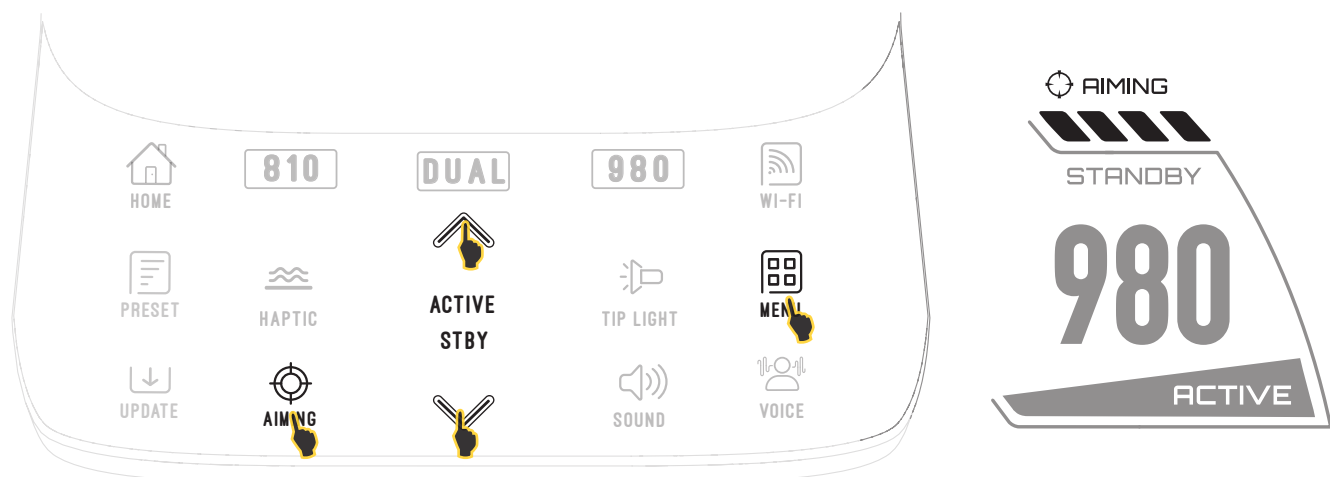

11 - PHOTOBIO-MODULATION (PBM) / WARNINGS & CAUTIONS



CAUTION: Do not connect or disconnect a PBM adapter while the Gemini EVO laser is turned on. Only connect or disconnect a PBM adapter when the Gemini EVO laser is inactive or standby mode.



CAUTION: Do not use any harsh chemicals or abrasives to clean the glass optics within a PBM adapter. Doing so may damage the glass.



CAUTION: Do not autoclave the 25 mm PBM adapter or spacers. Doing so will damage the components.



CAUTION: The spacers are single-use only to avoid possible cross-contamination. They must be disposed of after use in a bio hazard medical waste Sharps container.



CAUTION: Wavelength-appropriate eye protection must be worn at all times while using, and in proximity of, a PBM adapter while it is in use.



WARNING: The PBM adapters must only be used with a Gemini EVO laser. Do not attempt to use a PBM adapter with any other laser system or light source.



WARNING: Never look directly into a PBM adapter while the laser is active, even with safety eyewear on.



WARNING: Do not use the 25 mm PBM adapter without a spacer attached.

PBM COMPONENTS

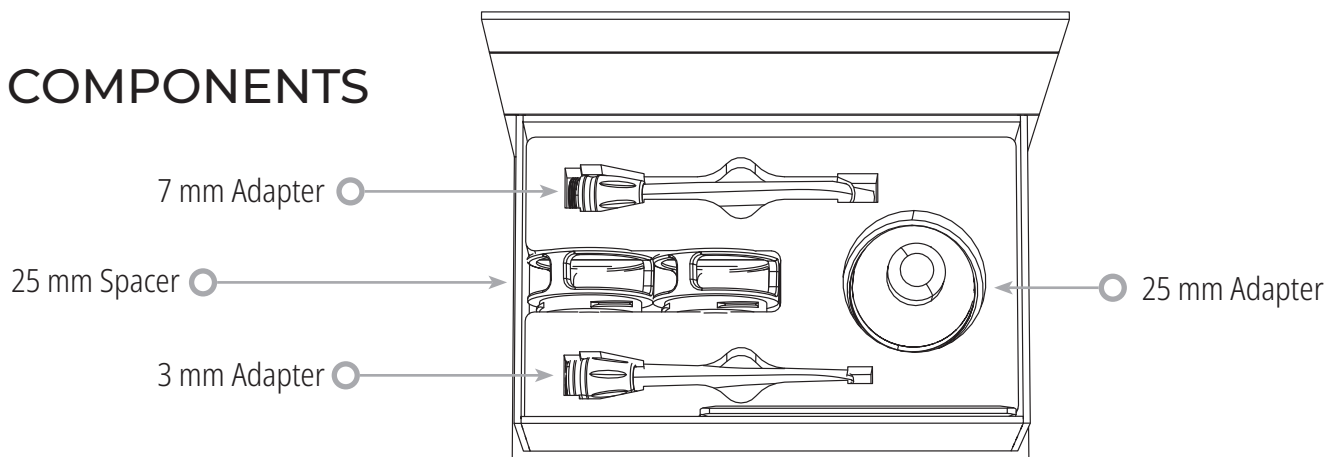

3 mm and 7 mm PBM adapters can be used intraorally

PBM ASSEMBLY (Attachment threading procedure applies to all PBM tips equally)

1. Remove the dust covers

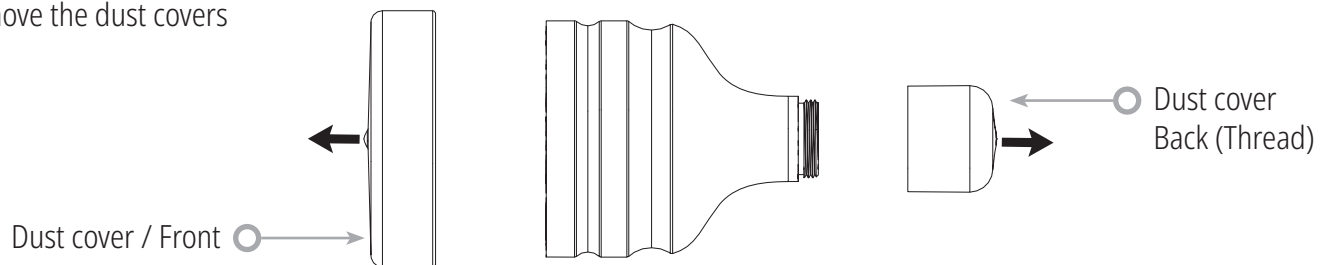

PBM dust covers for the 25 mm adapter should be wiped down with Caviwipes or equivalent product to avoid potential cross contamination.

2. Screw the PBM adapter onto the end of the Gemini EVO laser handpiece until it is tight.

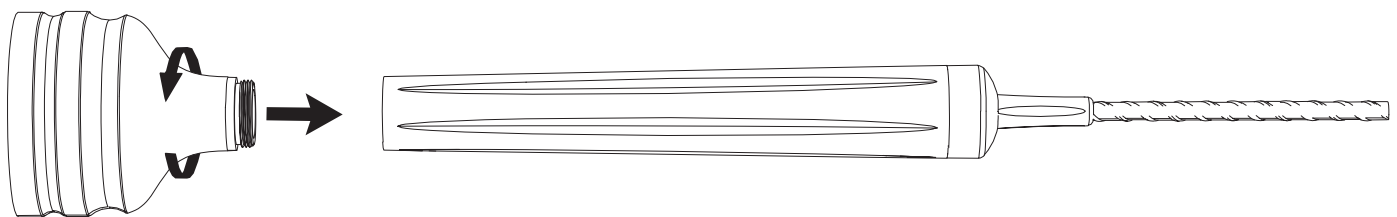

3. If using the 25 mm PBM adapter, a spacer must be attached to the end of the adapter for proper use. Simply screw the spacer onto the end of the 25 mm PBM adapter.

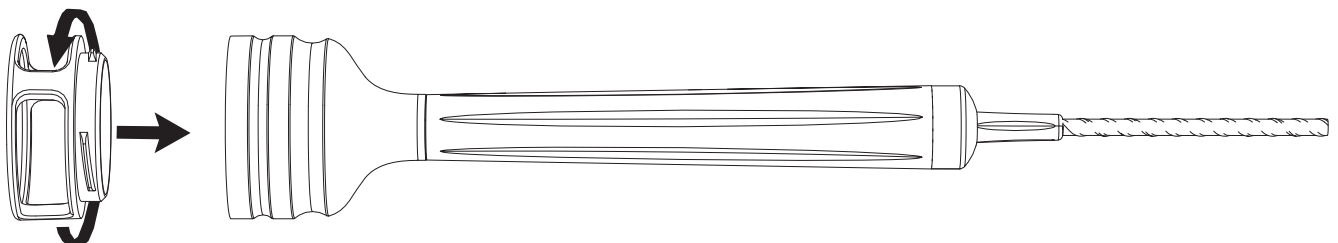

The PBM adapter is now ready to use. To remove the PBM adapter, unscrew it from the Gemini EVO laser handpiece, remove and discard the spacer, and re-install dust covers when not in use.

CONTROLS, OPERATION & USE

SELECTING AND ADJUSTING PBM PRESET

To enable Pain Relief, select PRESET on the Guided Touch Interface and navigate with the right arrow to the PAIN RELIEF category.

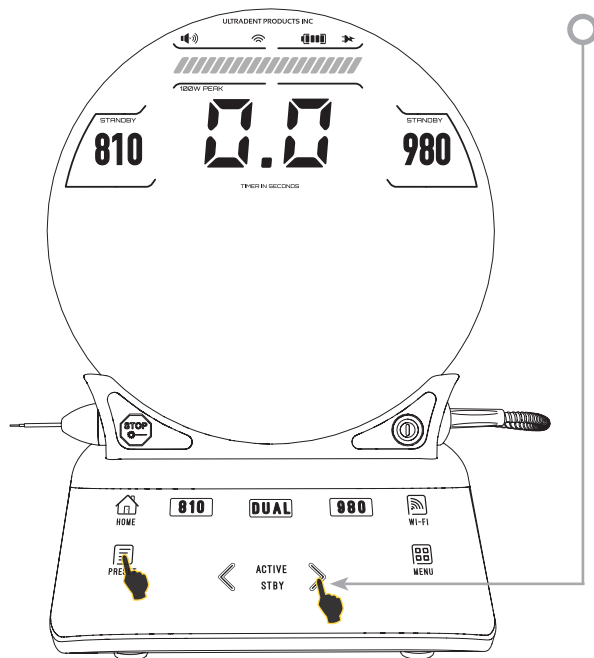

Use the UP / DOWN arrow to select the desired PBM adapter.

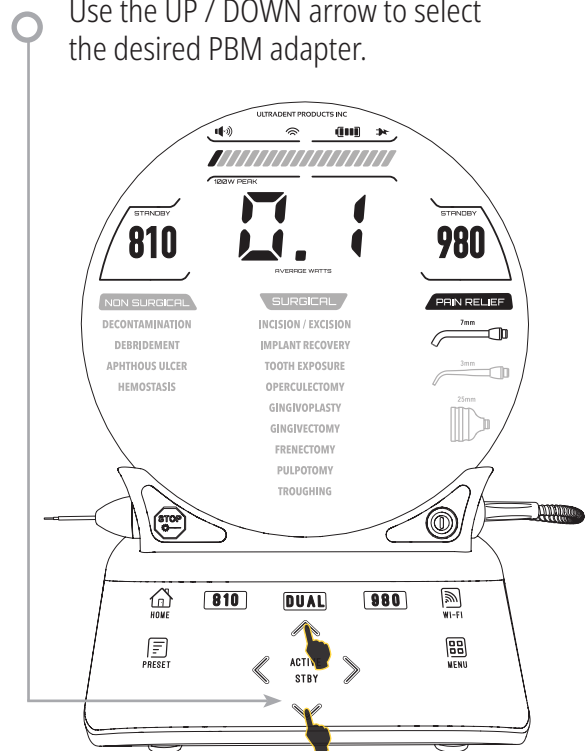

Click ACTIVE to select treatment time in seconds. Display will flash 0.0 seconds.



Using the right arrow select the time in seconds followed by ACTIVE to enable timer. Press and hold right arrow advances timer faster in 10 seconds increments.

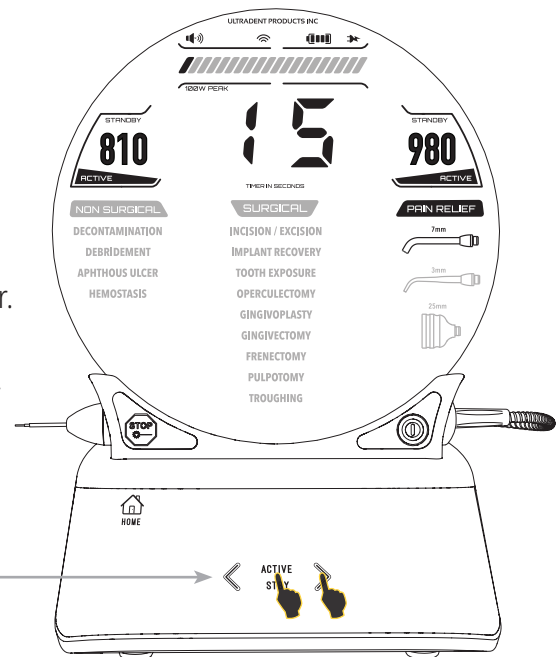

Laser unit is ready for PBM treatment. The timer counts down in seconds and stops automatically after treatment time is completed. If the activation pedal is released mid-treatment, the timer will pause and will resume when the pedal is depressed again.

USE RECOMMENDATIONS

Affected muscles and/or joints have to be exposed to an adequate level of laser energy over a period of time to provide effective results. Some cases may require more than one laser treatment, or a series of treatments, before significant improvement is reported. Repeat the treatment as necessary and monitor the progress of the patient's condition throughout the treatment.

Diode laser wavelengths, especially 810 nm, are well absorbed in melanin in the skin, which can lead to greater heating of the target tissues in patients with darker skin types. Power and treatment time should be taken into account for patients of varying skin pigmentation. Refer to the Fitzpatrick Skin Type Scale for proper skin classification.

Pain relief preset procedure settings are programmed into the Gemini EVO laser for ease of use. Always use professional clinical judgment when selecting the laser settings for pain therapy.

Monitor the patient and adjust the power and/or treatment time as necessary to ensure both efficacy and patient comfort. The preset procedure setting is not meant to be a clinical recommendation in any way.

When you are ready to begin treatment, hold the PBM adapter in contact with the target treatment area. The PBM adapter is designed to be held in a constant location for the duration of the treatment. If the desired treatment area is larger than the PBM adapter's spot size, move the adapter to a new location and start a new treatment only after the initial treatment time has elapsed.

PBM ADVERSE EVENTS & CONTRAINDICATIONS

If patient discomfort or reddening of the skin in the treatment area occurs at any time during treatment, you can do the following:

- Defocus the laser energy by moving the adapter a few centimeters back from the skin
- Decrease the treatment time
- Stop treatment

If blistering of the skin occurs, or the patient feels a burning sensation, immediately stop treatment and rinse the area with cool water or place a cold pack on the affected area for at least 5 minutes. Afterwards, apply a burn ointment or spray. **DO NOT USE ICE.**

- Do not use over articles of clothing
- Do not treat open wounds
- Do not apply ointment, creams, lotions, or heating lotion patches at, or in close proximity to, the treatment area.
- Do not apply therapies prior to treatment that could change body temperature, such as ultrasound, ice/heat pack, electrical stimulation, or heating patches.

PBM ADVERSE EVENTS & CONTRAINDICATIONS

- Avoid treatment sites with tattoos.
- Different implant materials will respond differently to laser energy and heat; be aware of any implants and their location; avoid direct exposure to laser energy or heat at the site of the implant.
- Excessive fatty tissue is known to transmit heat without much attenuation, therefore increase distance or decrease treatment time.
- Muscle tissue closer to the skin surface may experience a higher absorption of heat; carefully monitor skin temperature and reduce treatment time as necessary.
- Patients with swelling and/or inflammation may be sensitive to heat; reduce treatment time as necessary to ensure comfort during treatment.
- Patients with tender or sensitive skin may be hypersensitive to heat; reduce treatment time as necessary to ensure comfort during treatment.
- Scar tissue has been associated with poor circulation and reduced cooling through heat transport by blood; reduce treatment time as necessary to avoid overheating.
- Do not treat directly over the site of any known primary malignant carcinoma or secondary metastasis except for palliative care with informed consent and oncologist permission.
- Do not treat pregnant women as the effects of photobiomodulation therapy on the fetus are unknown.

PBM ADAPTER MAINTENANCE

When using the 25 mm PBM adapter, a spacer must be attached to the end of the adapter for proper use. The disposable spacers are supplied non-sterile by the manufacturer and should be wiped with isopropyl alcohol wipes by the operator prior to use. The spacers are intended for single-use only and should never be autoclaved or reused to prevent damage or cross-contamination.

The 25 mm PBM adapter is also provided non-sterile by the manufacturer and can be wiped as needed using isopropyl alcohol wipes. Do not submerge the 25 mm PBM adapter in any type of cleaning solution. **DO NOT AUTOCLAVE** the 25 mm PBM adapter.

Use the included cleaning cloth to gently wipe the glass optics of the 25 mm PBM as needed. Do not use any harsh chemicals or abrasives to clean the glass optics within the 25 mm PBM adapter. Doing so may damage the glass.

The 7 mm and 3 mm PBM adapters can be cleaned and sterilized per the instructions on pages 46-48.

PBM ADAPTER SPECIFICATION

	25 mm PBM Adapter	7 mm PBM Adapter	3 mm PBM Adapter
Dimensions	63 x 41 x 41 mm	100 x 24.7 x 14.9 mm	100 x 20.5 x 14.9 mm
Weight	76 grams	50 grams	50 grams
Spot Size	4.91cm ²	0.38 cm ²	0.07 cm ²
Power (under preset)	1.0 Watt Average	0.3 Watt Average	0.3 Watt Average
Power Density	204 mw/cm ²	780 mw/cm ²	4244 mw/cm ²

PBM DOSAGE TABLE

Time in Seconds	25 mm PBM Dose (J/cm ²)	7 mm PBM Dose (J/cm ²)	3 mm PBM Dose (J/cm ²)
03	0.6	2.3	12.7
06	1.2	4.7	25.5
09	1.8	7.0	38.2
12	2.4	9.4	50.9
15	3.1	11.7	63.7
18	3.7	14.0	76.4
21	4.3	16.4	89.1
24	4.9	18.7	101.9
27	5.5	21.1	114.6
30	6.1	23.4	127.3
33	6.7	25.7	140.1
36	7.3	28.1	152.8
39	8.0	30.4	165.5
42	8.6	32.8	178.2
45	9.2	35.1	191.0
48	9.8	37.4	203.7
51	10.4	39.8	216.4
54	11.0	42.1	229.2
57	11.6	44.5	241.9
60	12.2	46.8	254.6

12 - DISPOSABLE TIP OPERATION

The disposable fiber tip is relatively flexible, but can be broken if bent at an angle that is too sharp. Use the provided bending tool* to bend the tip to the desired angle. Do not bend the tip any more than the bending tool allows.

Protein debris from gingival tissue accumulates on the fiber tip during surgery and the heat that develops will deteriorate the optical efficiency. Fibers can fracture if a blackened area greater than 3–4 mm develops.

Replace the disposable, single-use fiber optic tip as necessary and for each new patient. The tips are provided in a sealed package. Each tip contains a pre-cleaved, pre-stripped piece of fiber. They are designed for single-use only and must be discarded after use.

For easy storage, you can clip and slide bending tool on the black optical fiber cable when the laser is not in use.

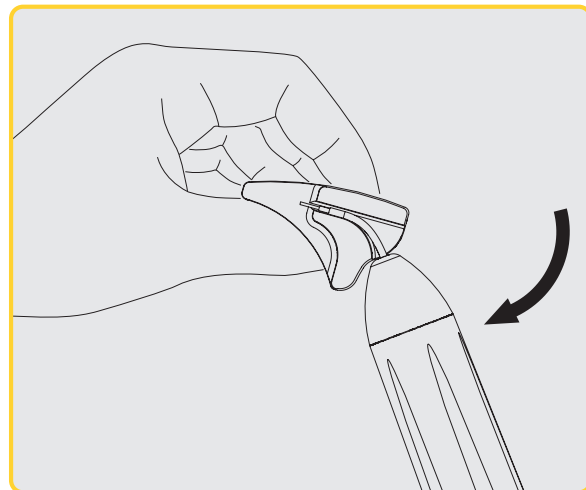
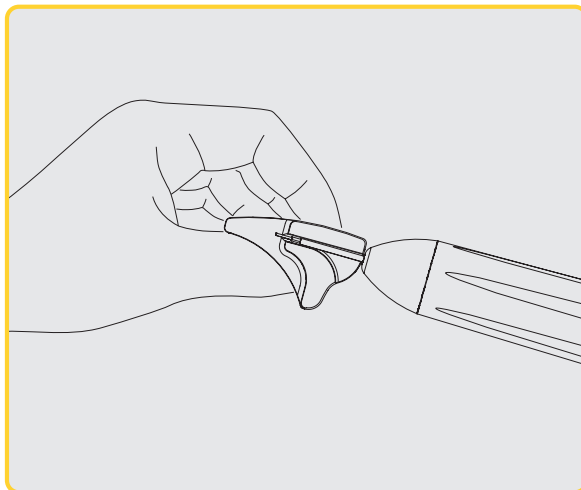
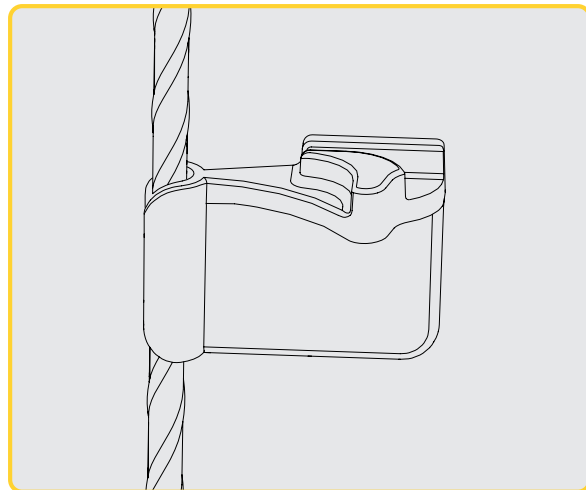
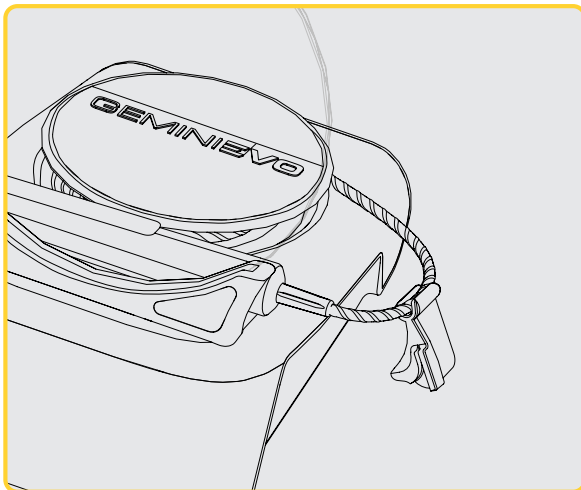

*Only use the bending tool with CLEAN tips prior to use. If the bending tool contacts a tip that has been used on a patient it must be disposed of in an infectious waste container (SHARPS).

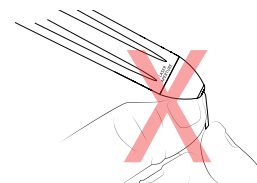
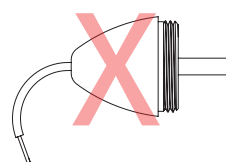
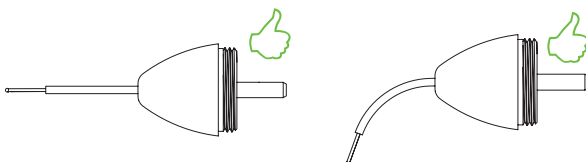

DO NOT OVERBEND TIP / DO NOT BEND WITH FINGER

DISPOSABLE TIPS

Gemini EVO laser's single-use 5 mm fiber tips are unique in that they come pre-initiated. That means there is black pigment added to the end of each fiber tip to help focus laser energy at the tip. All procedures that require the removal or cutting of soft tissue require an initiated tip.

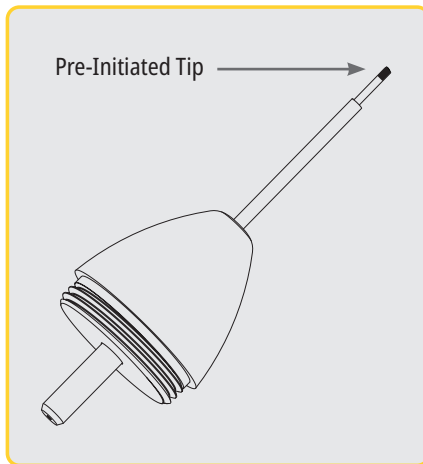

To ensure that the tip stays initiated when wiping the tip with isopropyl alcohol before a procedure, activate and fire the laser at 1 watt of average power for 1-2 seconds prior to wiping the tip. This action will ensure that the pre-initiation does not wipe off during the cleaning process.

Should you start treating a patient with an un-initiated tip, and then need to initiate the tip to continue treatment, rub the tip on articulating film while firing the laser on a low power setting. This will melt some dark pigment onto the fiber tip, thereby initiating it.

Laser procedures that do not remove tissue, such as decontamination or aphthous ulcers, do not require the laser tip to be initiated. Use a 7 mm un-initiated tip for these types of procedures.

If you are using a new pre-initiated 5 mm tip and want to un-initiate it, simply rub off the pigment at the end of the fiber tip with gauze and isopropyl alcohol. This pigment removal must occur before firing the laser with that tip.

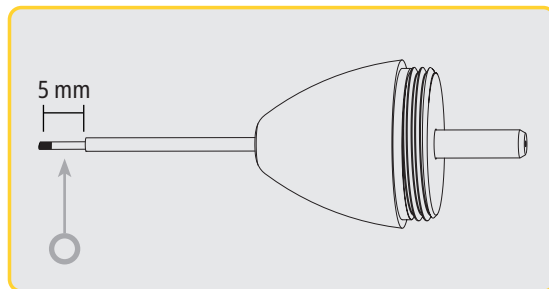

5 mm Tips (Pre-Initiated)

Surgical procedures such as Incision/Excision, Implant Recovery, Tooth Exposure, Operculectomy, Gingivoplasty, Gingivectomy, Frenectomy, and Troughing are some of the procedures recommended with a 5 mm tip.

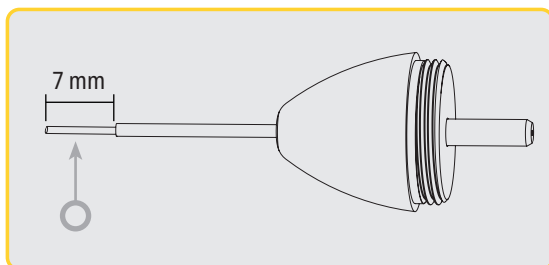

7 mm Tips (Un-Initiated)

Decontamination and Aphthous Ulcer are some of the procedures recommended with a 7 mm tip.

13 - BATTERY and BATTERY LEVEL INDICATIONS

The Gemini EVO 810+980 soft tissue laser is equipped with a Lithium-Ion battery capable of delivering a full day of laser usage. Simply connect the provided power supply to the rear of the unit and charging will start immediately.

It is recommended to fully charge the laser unit prior to initial use after unpacking.

The battery level indicator is located at the upper right corner of the display and shows battery percentage remaining.

 100% Usage Time: 2.0 Hours of consecutive max power of 2.0W

 75% Usage Time: 1.5 Hours of consecutive max power of 2.0W

 50% Usage Time: 1.0 Hour of consecutive max power of 2.0W

 25% Usage Time: 30 min of consecutive max power of 2.0W

 "Please connect power supply" reminder.

 0% Minimum of 60 minutes of charging is required before first use

To preserve battery life, the laser unit goes into "Inactivity" mode within 10 minutes of inactivity.

The Lithium-Ion battery has a typical lifespan of 2 years, at which time it is advised that the battery be replaced.

14 - POWER SUPPLY

Use only the provided 18V, 3.6A AC/DC power supply for charging the system battery and as an alternate laser power source. During initial setup use the AC/DC power supply for one hour to fully charge the battery.

Plug the power supply into an AC outlet and connect to the corresponding connector on the rear of the Laser Unit. Only use the power supply provided with the system.

WARNING: To avoid the risk of electric shock, this equipment must only be connected to a supply mains with protective earth.

ONLY USE THE 18V POWER SUPPLY WITH THE GEMINI EVO 810+980 DIODE LASER. OTHER POWER SUPPLIES INCLUDING THE POWER SUPPLY FROM OTHER GEMINI LASER PRODUCTS CAN CAUSE DAMAGE TO YOUR GEMINI EVO LASER UNIT.

15 - FIBER WRAPPING

A fiber wrapping system was built within the Laser Unit in order to provide a safe and convenient way to manage and store the optical fiber system. To store the fiber properly, always wrap in a clockwise direction to protect and store the fiber optic cable when not in use.

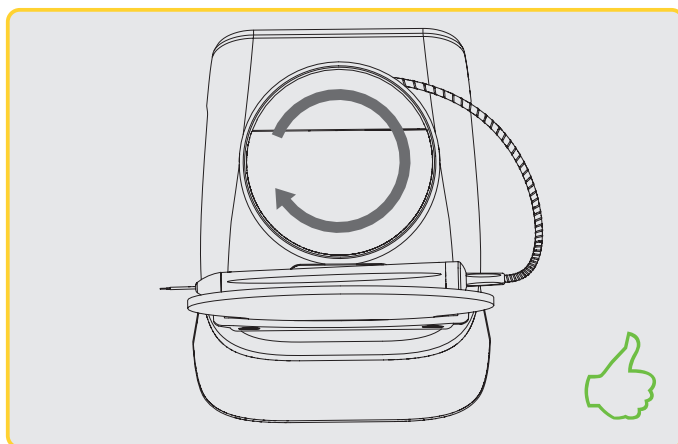
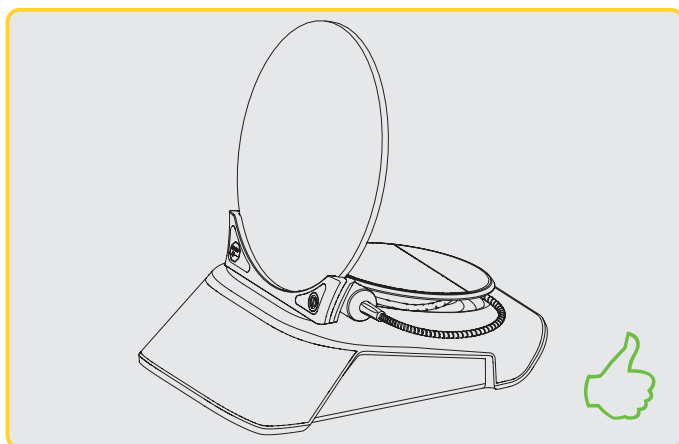

CAUTION: AVOID DAMAGING THE FIBER. Do not wrap the fiber in a counterclockwise direction. Doing so will possibly damage the optical fiber, preventing the use of the laser.

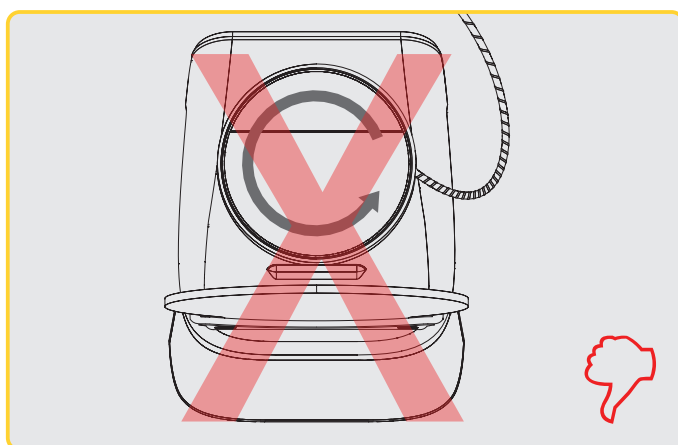
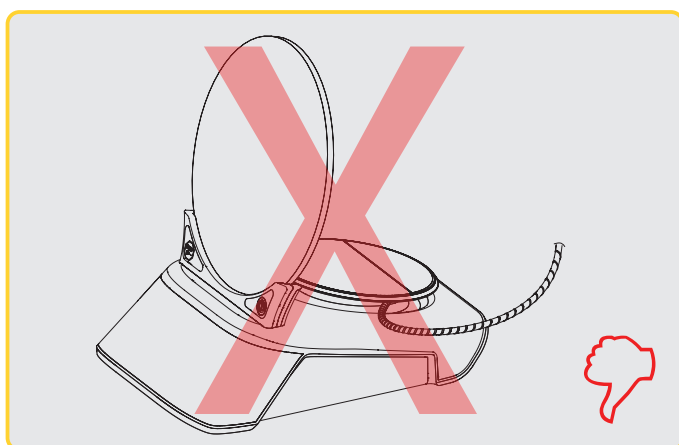

The fiber optic cable conducts laser energy from the laser diodes to the target tissues. These fibers are made of a thin glass silica. Note that there are potential hazards when inserting, steeply bending, or improperly securing the fiber optic tips to the handpiece. Failure to follow these recommendations may lead to damage of the fiber or delivery system, and/or harm to the patient, staff, or laser operator.

16 - HANDPIECE MAGNET

The Gemini EVO 810+980 soft tissue laser is designed with a magnet that will secure the surgical handpiece in place when the laser is not in use. Gently place the handpiece behind the transparent display or over the “rounded pad” of the laser unit and the magnet will hold the handpiece in place.

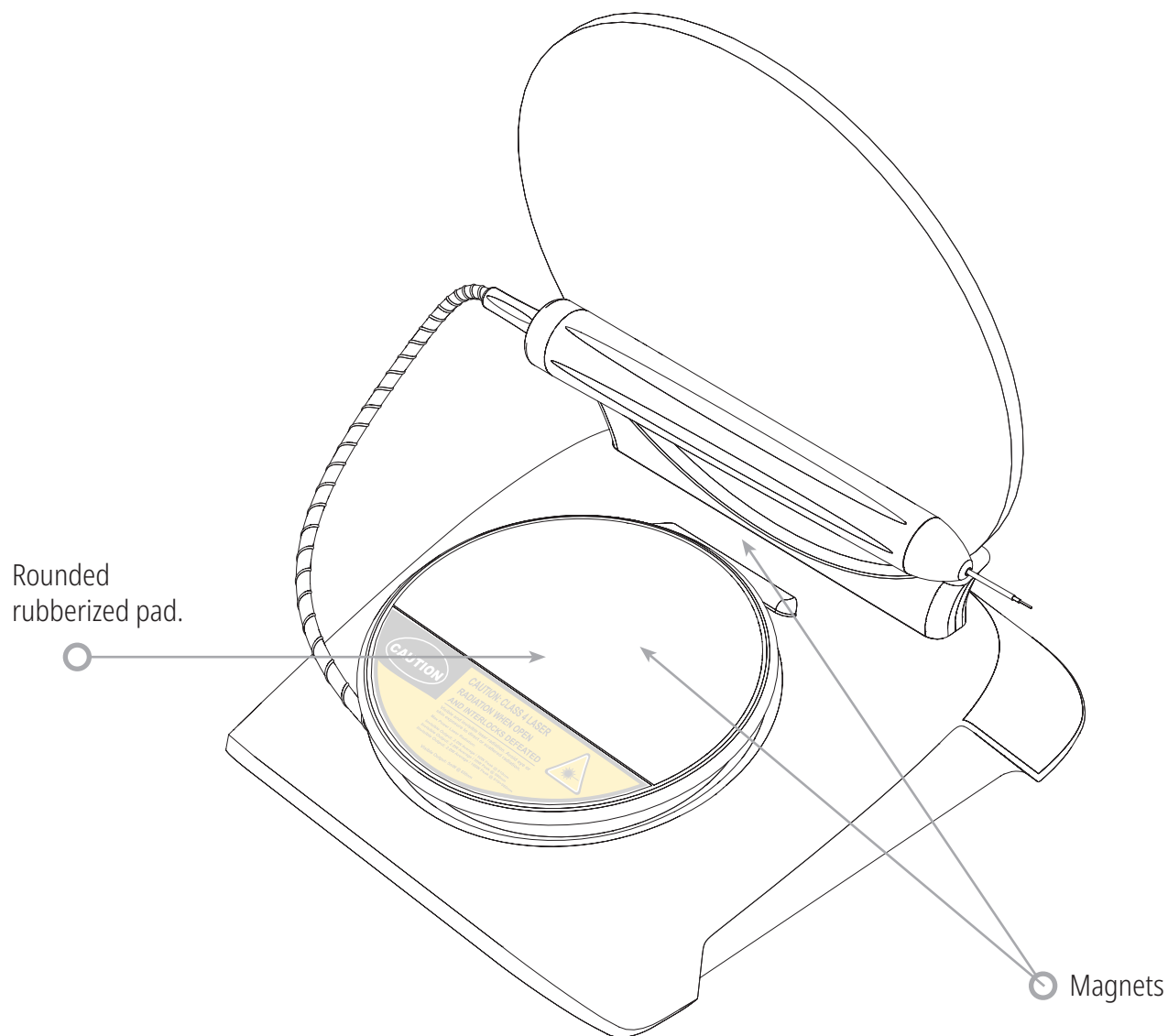

17 - OPERATING MODE

The Gemini EVO 810+980 soft tissue laser will only deliver energy in Pulsed “temporal emission mode” and is optimized to provide the operator ideal control of target tissue temperatures and efficiency of energy delivered. The pulse width is fixed and not user adjustable. The operator will only need to adjust the laser wavelength and average power.

18 - EMERGENCY STOP

The Gemini EVO 810+980 soft tissue laser can be immediately deactivated in any mode, at any time, and in any power setting by pressing the red STOP button located in the front left of the system.

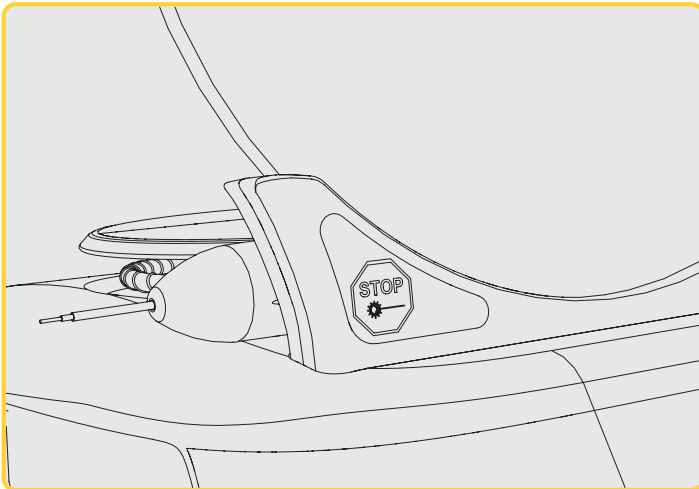

19 - REMOTE INTERLOCK (Switch not Included)

The Gemini EVO 810+980 soft tissue laser provides a remote interlock feature that enables a clinician to establish a dedicated laser treatment room with a remote interlock connector. A switch on the entrance door is attached and is electronically wired into the Laser Unit via 3.5 mm plug jack. When the door to the room is opened, the connector/switch provides an electrically open circuit that deactivates laser emissions. To use the remote interlock feature, an interlock connector/switch and cable must be purchased. Contact the manufacturer for assistance.

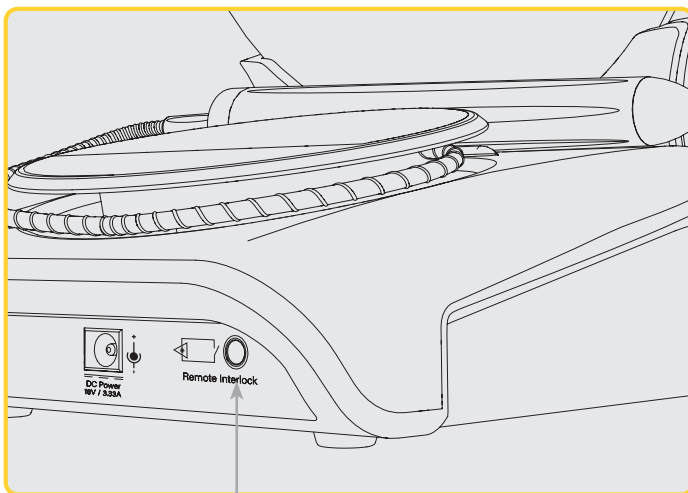

○ 3.5 mm Plug Port

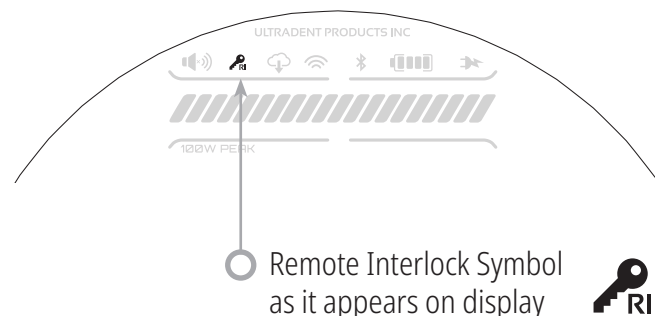

20 - ADD NEW ACTIVATION PEDAL OR RECONNECT / PAIR BLUETOOTH CONNECTION

In certain instances, your office may need to have an additional Activation Pedal with the same Gemini EVO device, or you may lose your Bluetooth pairing connection. In either case, follow the instructions below to properly reconnect and establish Bluetooth pairing connection with your Gemini EVO unit. **For a successful pairing, the sequence below must be followed:**

1 DEPRESS THE PEDAL

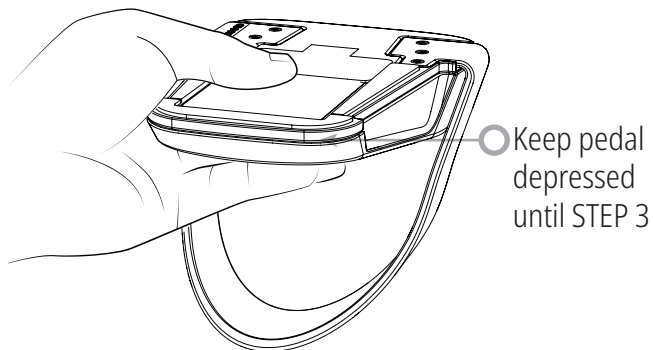

If batteries are installed, remove both of them. Keep the pedal depressed until the completion of STEP 3.

2 INSTALL BATTERIES

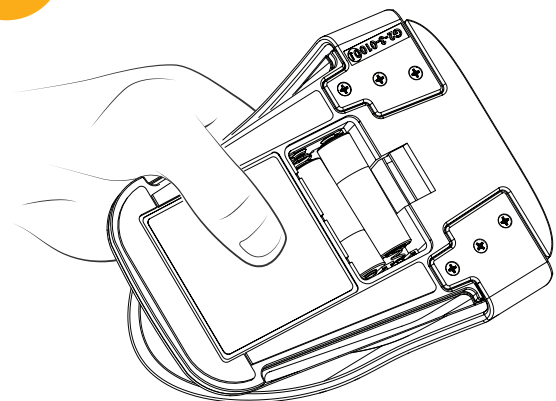

Keep the pedal depressed. Install the 2 batteries and keep the pedal depressed for 15 seconds.

3 FLASHING ICONS

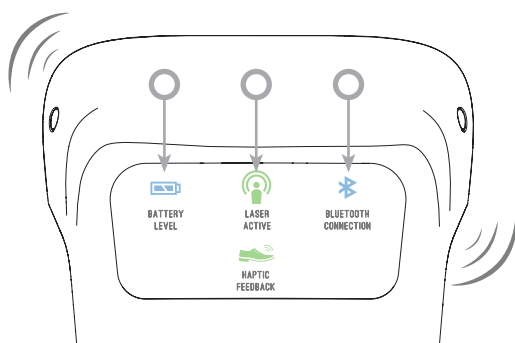

Activation Pedal icons will flash simultaneously along with the haptic feedback indicating pairing mode sequence has started. You can now release the pedal.

4 PAIRING

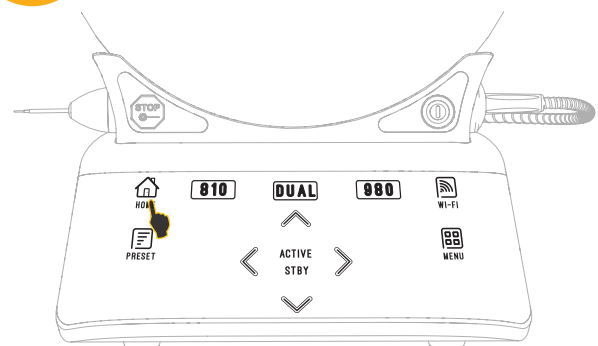

Press and hold the HOME icon for 5 seconds.

🔊 "Bluetooth Pairing Enabled"

5

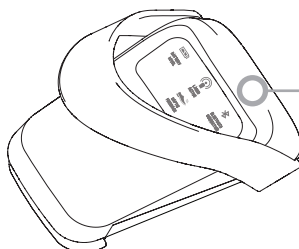

Activation Pedal automatically connects to your Gemini EVO device.

🔊 "Bluetooth Pairing Successful"

21 - TRANSPARENT ELECTROLUMINESCENT DISPLAY

The Gemini EVO 810+980 soft tissue laser is designed with transparent electroluminescent display that can provide high resolution viewing angles from up to 160 degrees of field of view.

The transparent display was specially designed with over 80% transparency and an arch of 15 degrees for optimal viewing angle from any direction. The light is generated by a thin film, less than 2 microns thick, of specially designed electroluminescent phosphor.

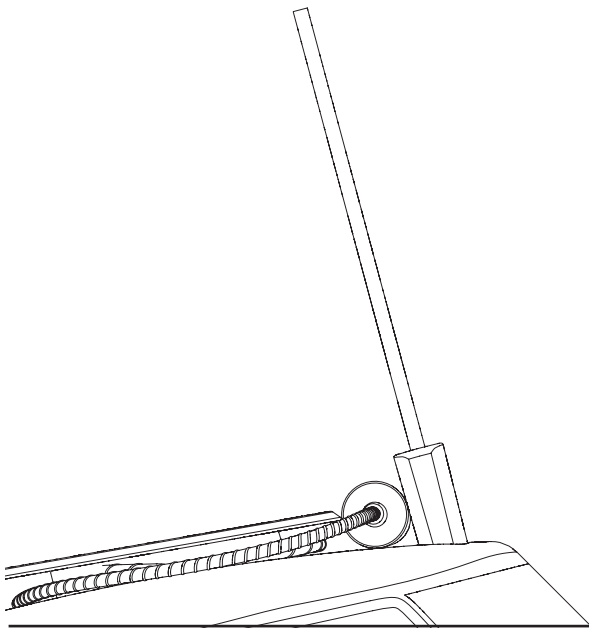

DISPLAY SPECIFICATIONS

Display type:	Electroluminescent
Transparency:	80%
Brightness:	300 cd/m ²
Color:	Broadband Yellow
Peak Wavelength:	582 nm
Voltage:	~195V AC
Response time:	1.8ms
Glass type:	Soda lime
Glass thickness:	4.1 mm fused
Thin Film Thickness:	~2 micron

DO NOT GRAB DISPLAY THIS WAY

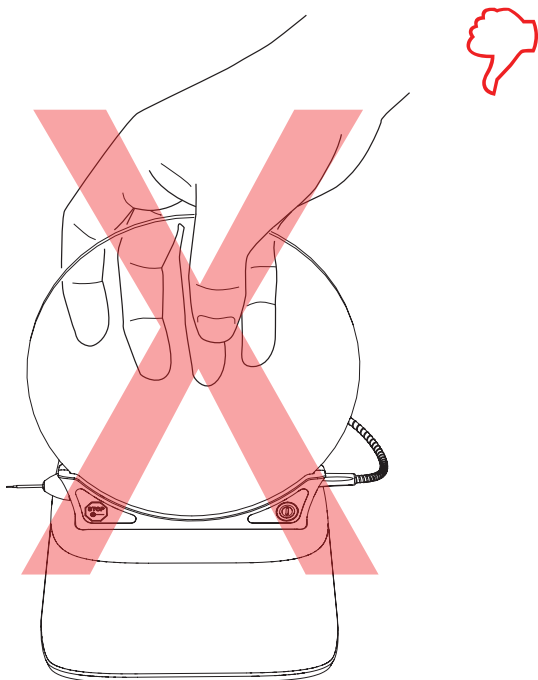

GRAB UNIT BY THE BASE

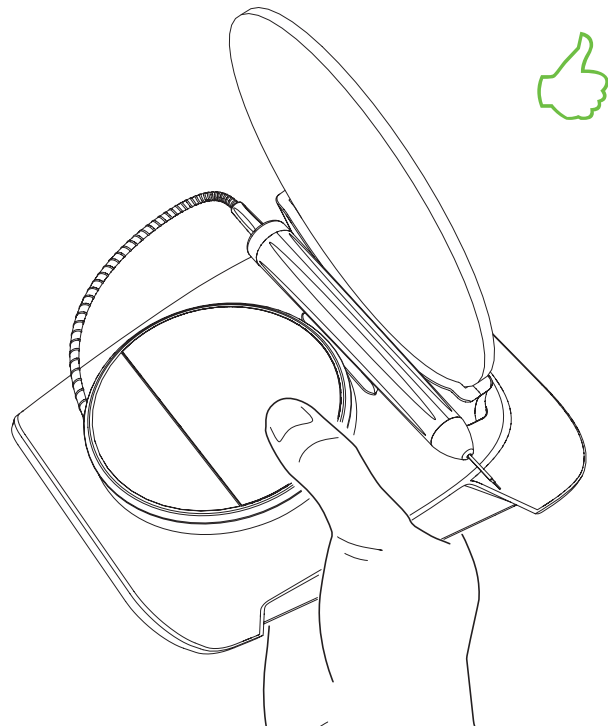

22 - ENABLING WI-FI CONNECTIVITY VIA APP

The Gemini EVO 810+980 soft tissue laser enables you to bridge your location's existing Wi-Fi network directly to the Gemini EVO unit. This provisioning enables your Gemini EVO unit to receive internet connection, allowing the user to receive important performance updates, technical support, track procedures, and a multitude of other features.

To properly enable Wi-Fi connectivity, please follow the steps below:

	1.	<h3>Download the mobile App</h3> <p>The Gemini EVO Laser App is available for iOS and Android devices. On your mobile app store, search for Gemini EVO laser.</p>	
	2.	<h3>Registering and authenticating your device</h3> <p>Once you have the App installed, select "I need an account" and follow the easy step-by-step instructions to register your laser. Registering your unit is an important step to allow your Gemini EVO laser to receive internet connection. You will receive an authentication code via email.</p>	
	3.	<h3>Scan your laser</h3> <p>Your Gemini EVO unit contains a unique QR code located on the bottom of your unit or activation pedal. Point your phone camera to the QR code and the app will scan the laser unit. You can nickname your Gemini EVO laser any name you like and click SAVE.</p>	
	4.	<h3>Enabling Wi-Fi</h3> <p>After saving your device name above, follow the simple steps on the App in order to enable the laser unit to start talking to your local Wi-Fi network.</p> <ol style="list-style-type: none">1. Turn the Gemini EVO unit ON2. Enter passcode3. Select wavelength (any wavelength)4. Press and hold the Wi-Fi icon for 3 seconds. "Wi-Fi Setup in Progress" voice confirmation is heard. Move to next step to select a local Wi-Fi.	

MOBILE APP & DASHBOARD

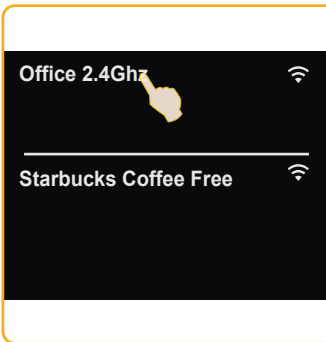

5.

Selecting a Wi-Fi network

A list of Wi-Fi networks will be displayed. Please select the Wi-Fi network associated to your office location and enter appropriate password. Please note the Gemini EVO Laser Wi-Fi is compatible with 2.4 GHz networks only. **If you have a secure firewall or Anti-Virus software, you may need to contact your network administrator in case there are difficulties connecting to your local Wi-Fi network.**

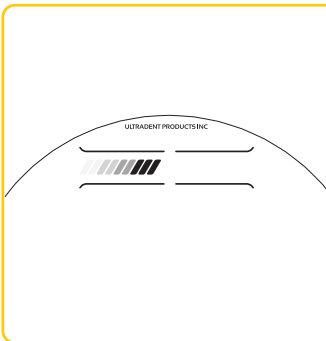

6.

Establishing a Wi-Fi Connection

After selecting the appropriate Wi-Fi network and entering the password, the Gemini EVO unit will establish a secure connection with your local Wi-Fi. The Wi-Fi connection between your local Wi-Fi network to the Gemini EVO unit can take up to 2 minutes to complete. The Gemini EVO unit displays a progress bar on the electroluminescent display. Upon connection the App displays the main page shown below.

The screenshot shows the main dashboard of the mobile app. At the top, there is a yellow header bar with the text "YOUR OFFICE NAME" and a three-dot menu icon. Below the header, there are two columns of icons. The left column includes: a Wi-Fi icon, an "Updates" icon (a square with a downward arrow), a "Devices" icon (a QR code), a "Videos" icon (a play button), and a "Log Out" icon (two people with arrows). The right column includes: a "Status" icon (a gear), a "Warranty" icon (a camera), a "Dashboard" icon (a pie chart), a "User Manual" icon (an open book), and an "Account" icon (a person with a gear). Labels with arrows point to these icons from both sides of the phone. On the left side, labels include: "Gemini EVO laser name given during registration" (pointing to the header), "Wi-Fi connectivity status Green = Connected to Wi-Fi Red = Not connected to Wi-Fi" (pointing to the Wi-Fi icon), "Latest available software update" (pointing to the Updates icon), "Add / Remove Gemini EVO devices" (pointing to the Devices icon), "Videos, Instructions, Techniques" (pointing to the Videos icon), and "Log in and out different users" (pointing to the Log Out icon). On the right side, labels include: "Edit name registered" (pointing to the three-dot menu), "Overall Laser unit information Green = Receiving status Red = Not receiving status" (pointing to the Status icon), "Extended warranty availability and status" (pointing to the Warranty icon), "Usage statistics" (pointing to the Dashboard icon), "Up to date User's Manual" (pointing to the User Manual icon), and "Account info / Change personal information" (pointing to the Account icon).

Similar to identical user interface for Android users. Layout is subject to change based on future updates on all platforms.

MOBILE APP & DASHBOARD

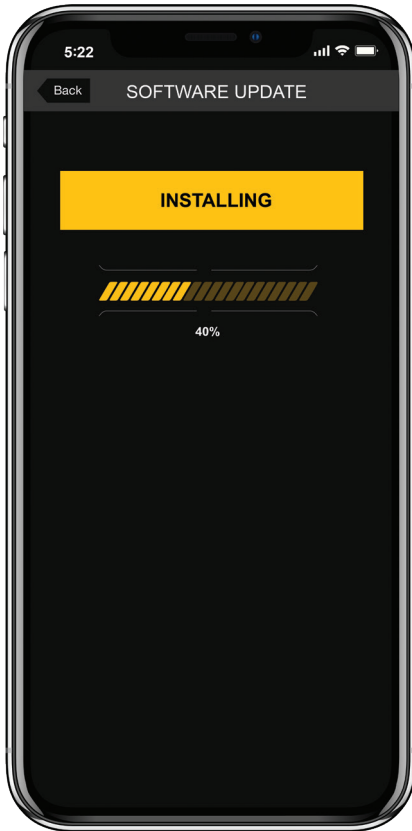

Updates

With the iOS and Android App, you can perform automatic updates directly to your Gemini EVO laser. Automatic updates are extremely important as it enables your Gemini EVO laser to utilize the latest and greatest improvements.

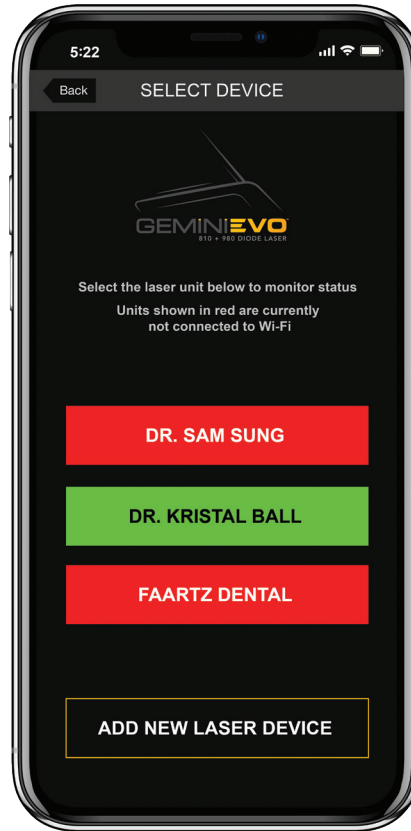

Devices

This page will enable you to add or remove a Gemini EVO device from your registered account. You can have multiple Gemini EVO devices registered with one account. Units shown in green are currently online. Units shown in red are currently offline.

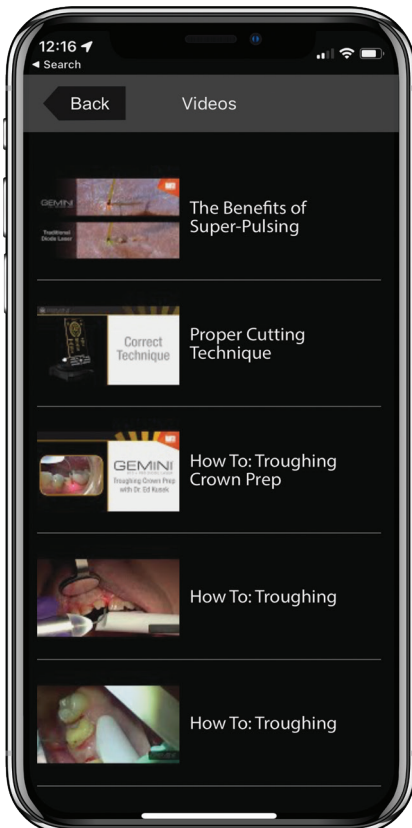

Videos

The videos tab will show you several of the procedures that can be performed with the Gemini EVO laser. Additionally, we will upload the latest techniques and customer tips as reference.

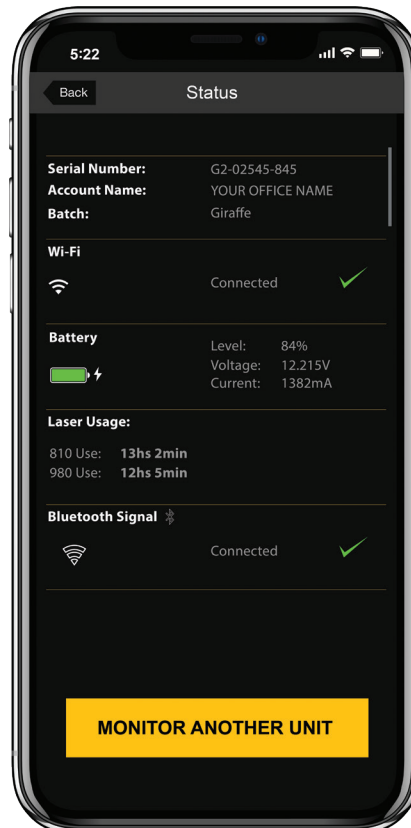

Status

The status tab will show several important status conditions such as the health of your battery, the strength of your Wi-Fi connection, and the ability to add and remove another Gemini EVO laser from your account. The Status page is the overall health of your Gemini EVO device.

(Reference image only actual screen may be different)

MOBILE APP & DASHBOARD

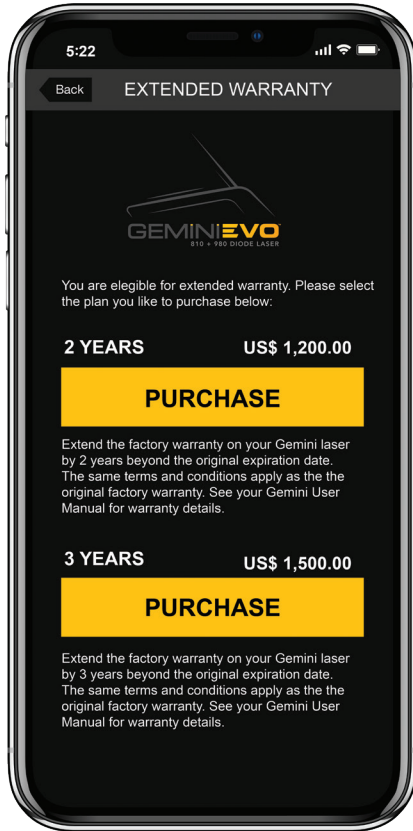

Warranty

With the iOS and Android apps, you can purchase extended warranty if qualified. The Gemini EVO laser comes with 2 years limited factory warranty. You can extend your factory warranty to an additional 24 or 36 months. Warranty starts from shipment day. Prices shown are subject to change.

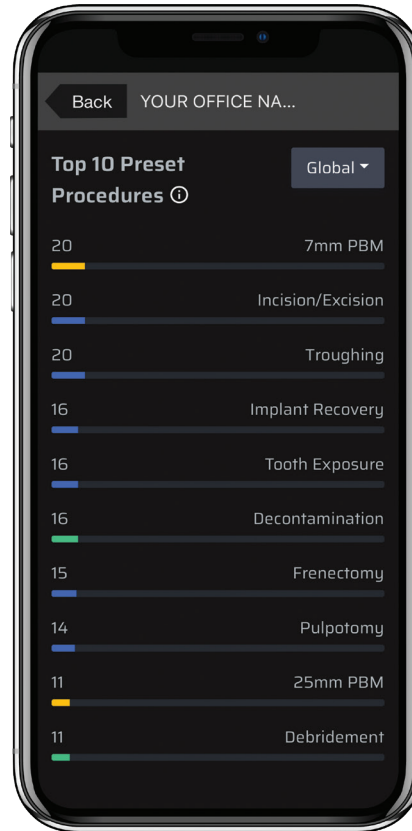

Dashboard

With the Gemini EVO app, you can track how many procedures have been performed by category, see which wavelength mode is used the most, as well as the overall laser usage time of this Gemini EVO device.



User Manual

With the iOS and Android apps, you can have access to the user's manual at any time. The user's manual will always contain the latest update, enabling you to always have access to the latest documentation.

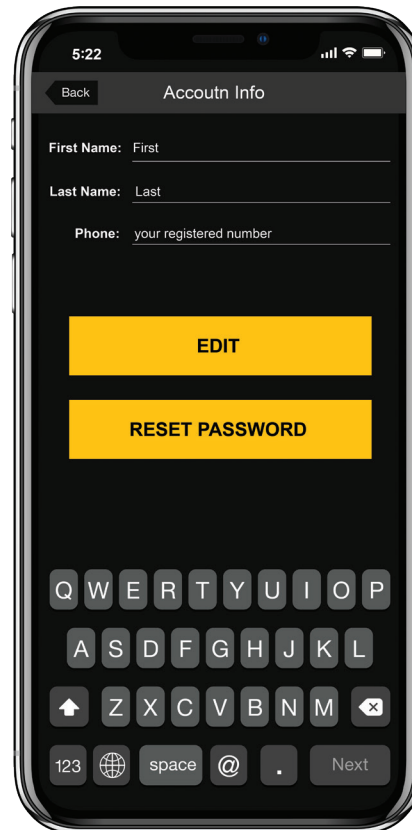

Account

The account page allows you to change your registered name, phone number, and product nickname. This is an important feature in case the Gemini EVO device is exchanged with another office.

MOBILE APP & DASHBOARD

WEB INTEGRATION VIA THE DASHBOARD



Once connected to Wi-Fi, the GEMINI EVO 810+980 Soft Tissue Laser will share data with the DASHBOARD, which will enable you to visualize several parameters of your laser. In order to get access to the Dashboard, the user must have completed the registration process via the iOS or Android App.

Login to dashboard.geminievo.com and use the same login credentials created within the App for iOS and Android devices.

The Dashboard is being constantly improved. Some of the features listed might be different and updated/improved since product inception. Our goal is to always improve the system based on customer feedback. If you have an improvement suggestion, please email it to feedback@azenamedical.com and we will do our best to analyze and implement it into our next update cycle.

MENU

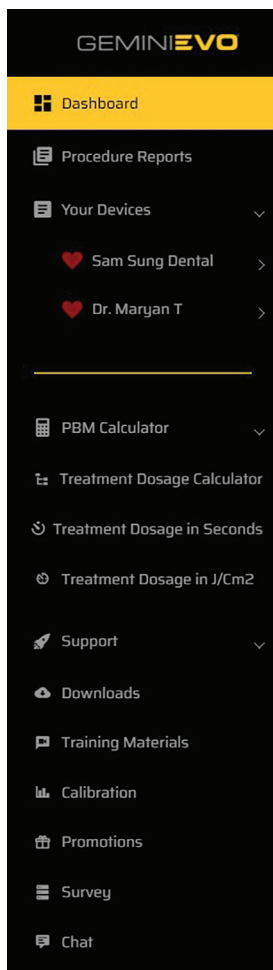

The main menu features several well organized links to help the user manage their Gemini EVO device. Some of the available features are:

- Get overall visual of everything happening with your Gemini EVO
- Procedure Reports displays all procedures performed, time, power settings; great for patient notes

Select All	Date of Procedure	Procedure Type	Power	Wavelength	Treatments	Dosage	Procedure Length	Serial Number	Time
<input type="checkbox"/>	Dec 7th 2021	Gingivectomy	0.9 Watts	DUAL			2 mins, 25 sec	00057	7:35:42am
<input type="checkbox"/>	Dec 6th 2021	Manual	1.2 Watts	DUAL			25 sec	00708	1:26:17pm
<input type="checkbox"/>	Dec 6th 2021	Manual	1.2 Watts	DUAL			35 sec	00708	1:24:25pm

- Vitals showing the overall health of your Gemini EVO device
- Customize preset settings and procedure fees for ROI tracking
- PBM Calculator lets you visualize PBM treatments based on pain level, tissue color, or time

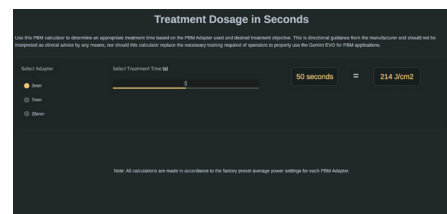
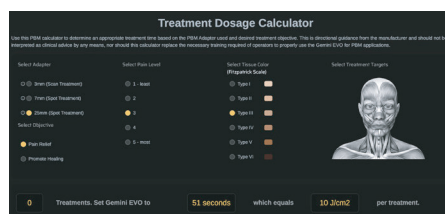

- Download the latest electronic version of this User's Manual
- Watch the latest training videos
- View the calibration of your Gemini EVO and download the certificate
- Get access to special promotions only available via the Dashboard
- Help us improve Gemini EVO by taking a quick product survey
- Talk to us live via the support chat available during business hours

MOBILE APP & DASHBOARD

DASHBOARD

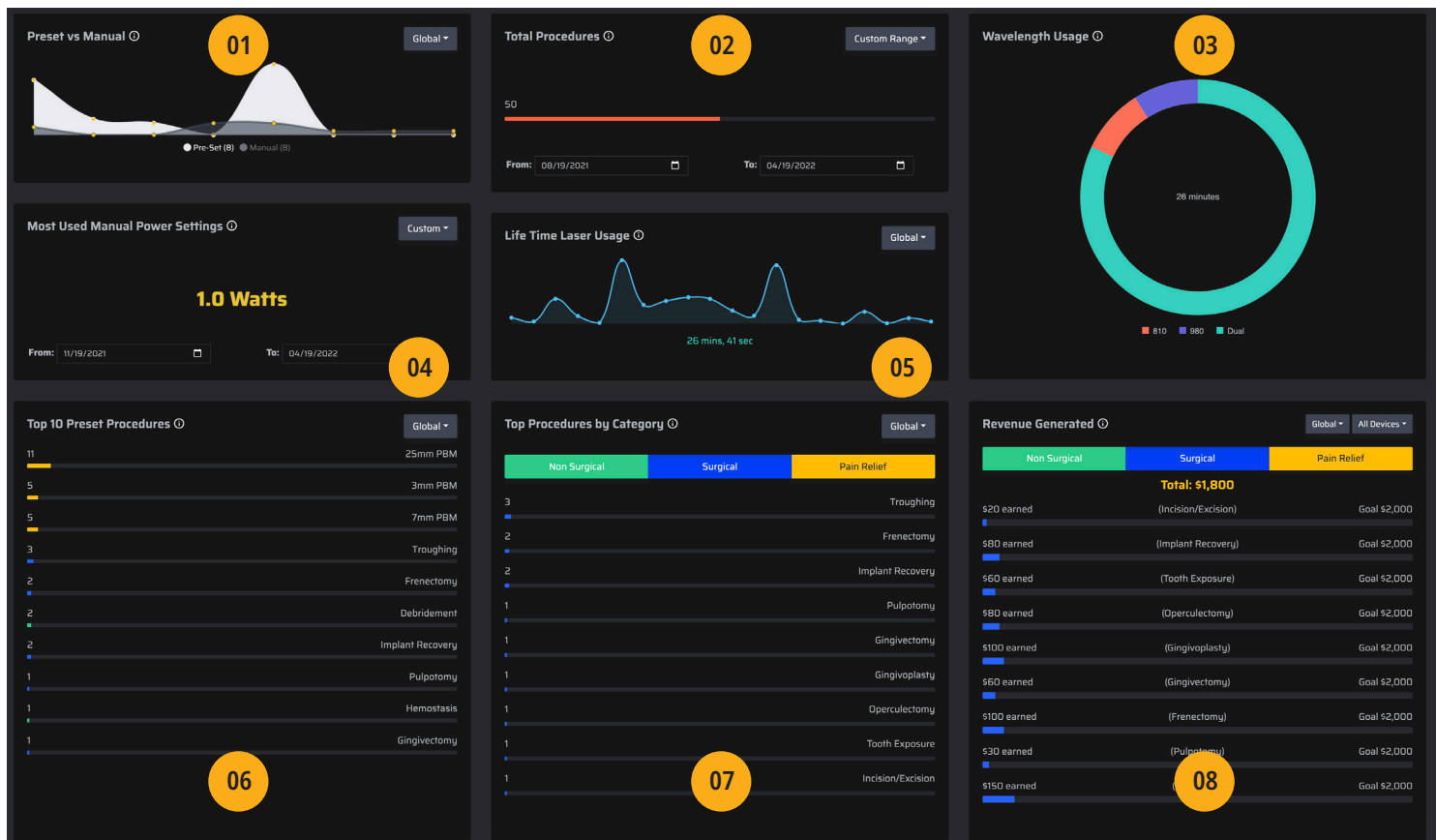

01 - Pre-Set vs Manual

This feature shows graphically the procedures performed manually vs with pre-sets. This is a good way to visualize which procedure method the user is more comfortable using.

02 - Top Procedures

This feature shows graphically the top procedures performed. As with all statistics, the user can select today's day, week, month or a custom range to be displayed.

03 - Wavelength Usage - Global

This feature will display graphically which wavelength the user has used the most.

04 - Most used manual power settings

This feature will display graphically the most commonly used average power in manual mode.

05 - Lifetime Laser Usage

This feature will display the total amount of time the laser has been used. This is similar to a car odometer. It stays with the device.

06 - Top 10 Preset Procedures

This feature shows the top procedures performed by name and by category. This is a good way to visualize which procedure is most performed by the user.

07 - Total Procedures by Category

This feature shows the total amount of procedures performed in a specific period of time.

08 - Revenue Generated

After adding the price and revenue goal of each procedure for the user's practice, the revenue report will automatically display the revenue earned and goal progress for each procedure.

MOBILE APP & DASHBOARD

DASHBOARD - VITALS - UNIT SPECIFIC

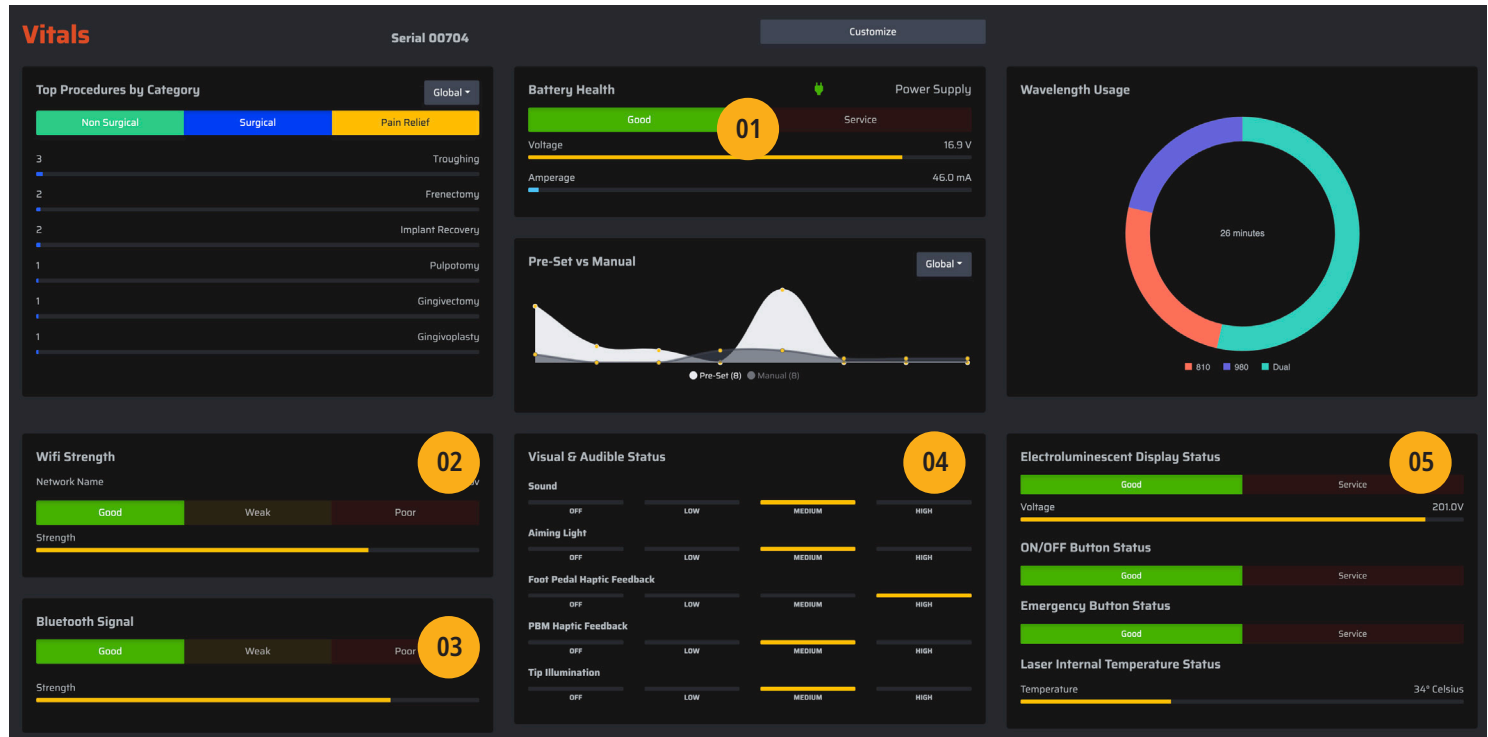

The vitals page will display specific information about your Gemini EVO device by unique serial number. This type of information is helpful while troubleshooting or visualizing a feature when the user has a functionality issue.

01 - Battery Health

The Gemini EVO is constantly monitoring its battery for maximum efficiency. At any point if the battery requires service or replacement, the SERVICE alert will be red. Under battery health you can also visualize when the unit is being powered by the power supply.

02 - Wi-Fi Strength

Once connected to your local Wi-Fi network, vitals page will show the quality of your network and name of the local network you are connected to. Under poor network conditions, the Dashboard information might be slightly delayed.

03 - Bluetooth Signal

When your Gemini EVO connects with your activation pedal under ACTIVE mode, the network strength bar will be

displayed. If connection shows weak or poor, move your activation pedal closer to the Gemini EVO device.

04 - Visual and Audible Status

Visual and Audible settings are the most common settings used with Gemini EVO. Being able to quickly visualize those settings will help you get an overall overview of your selections. Under haptic feedback settings, which shares the same icon on the Guided Touch Interface, this feature will allow you to see both haptic settings on a single screen.

05 - Display / ON-OFF Buttons and Laser Temperature

Your Gemini EVO is constantly monitoring its own performance. If there is any issue with any of these items, the SERVICE alert will be red indicating a possible problem. This information is important for customer service and will help them troubleshoot further.

DASHBOARD - CUSTOMIZE

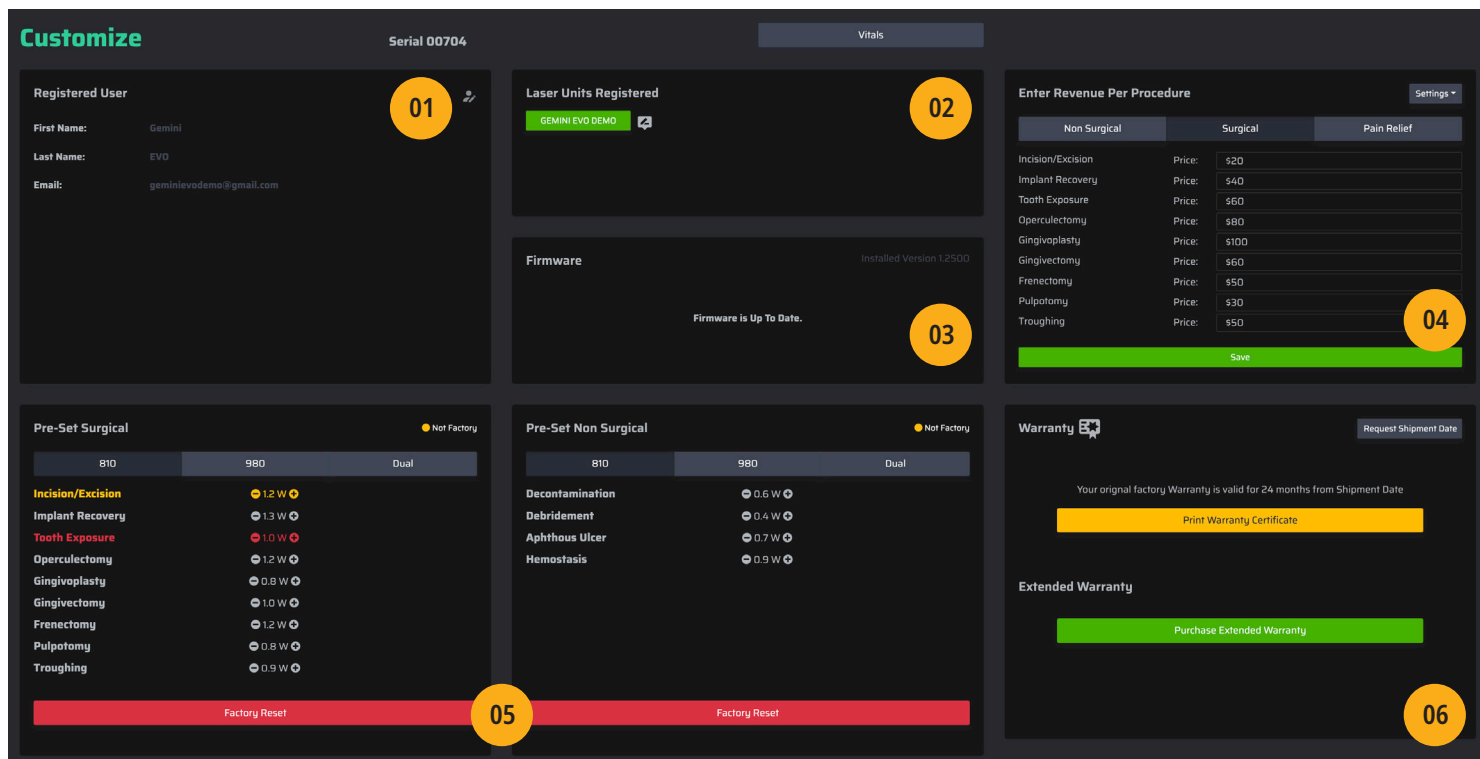

The customization page enables you to customize settings on your Gemini EVO device.

01 - Registered User

This is where you can change your registered name and phone number. E-mail address is your login information and in order to change that the user must call customer service.

02 - Laser Unit Registered

You can change the name of your Gemini Evo. You can also change the name over the iOS and Android apps.

03 - Firmware - Software Updates

You can update your Gemini EVO to the latest software when an update is available by simply clicking UPDATE. You can also update your Gemini EVO via the iOS and Android apps along with the update icon on your Gemini EVO Guided Touch Interface.

04 - Revenue Tracker

You can add the price of each procedure per your office's fee schedule. Additionally you can set goals for each procedure and track your objectives under the main dashboard. If your device is outside the United States, you can change currency by selecting the top right menu.

05 - Custom Presets

Your Gemini EVO comes with preset procedures settings where the power is already set for optimal performance. At times, it may be necessary to change these settings. In order to do that, simply select the + / - icon to adjust to the new preset power. Procedures that show yellow as preset are custom selected by the user within recommended power range for that particular procedure. Procedures that show red as preset are custom selected by the user but are outside of the recommended range by the manufacturer. All procedures can be factory reset by clicking factory reset button.

06 - Extended Warranty

When available based on serial number, extended warranty option may be listed for purchase. Simply follow the on-screen instructions to purchase 2 or 3 years of extended warranty. A Warranty certificate will be available for download after purchase.

CLEANING AND STERILIZATION PROCEDURES

GUIDELINES

The Gemini EVO™ 810 + 980 Soft Tissue Laser is not supplied in sterile condition, nor must it be sterilized before use with the exception of the handpiece, 3 mm PBM, and 7 mm PBM tips. The following cleaning and sterilization procedures are recommended before the initial use and after each subsequent use:

1. The disposable fiber tips are supplied non-sterile by the manufacturer and should be wiped with isopropyl alcohol wipes by the operator prior to use. The tips are to be discarded in an infectious waste container (SHARPS) after each use. There is no reuse or reprocessing procedure indicated for the disposable fiber tips.
2. The aluminum handpiece, 3 mm, and 7 mm PBM adapters are also provided non-sterile by the manufacturer and should be cleaned and sterilized prior to initial use and after each use following these instructions:

CLEANING

The cleaning process is intended to remove blood, protein, and other potential contaminants from the surfaces and crevices of reusable accessories. This process may also reduce the quantity of particles, microorganisms, and pathogens present. Cleaning must be performed within a maximum of 1 hour after the procedure and always prior to sterilization:

1. After use, carefully remove the disposable fiber tip from the handpiece and dispose of in an infectious waste container (SHARPS).
2. Clean the handpiece and attached fiber cable by using one CaviWipes® towelette, or equivalent product, to completely pre-clean exposed areas of all gross debris. Be sure to wipe the threaded area where the disposable tip attaches. The same procedure applies for 3 mm and 7 mm PBM adapters. PBM adapters must be removed from handpiece prior to cleaning.
3. An FDA-cleared barrier sleeve, made for dental instruments, should be used on the 3 mm and 7 mm Intraoral PBM adapters before being used. Discard after each use and follow proper sterilization instructions.
4. Use a new towelette to thoroughly wet all pre-cleaned areas—keeping all areas wet for 2 minutes at room temperature (68° F/20° C). Repeated use of towelettes may be required to ensure that the surfaces remain visibly wet.
5. Visually inspect the handpiece to ensure there is no visible debris remaining. If necessary, continue wiping with CaviWipes towelette until all visible debris is removed.
6. Wipe all exposed areas of the handpiece shell with isopropyl alcohol wipes to remove any residue left by the CaviWipes towelette.

WARNING:

**THE GEMINI EVO™ 810 + 980 SOFT TISSUE LASER AND ITS COMPONENTS
CANNOT BE CLEANED WITH AN AUTOMATED CLEANING PROCESS.**

CLEANING AND STERILIZATION PROCEDURES

STEAM STERILIZATION

The steam sterilization process is intended to destroy infectious microorganisms and pathogens. Always perform the sterilization procedure immediately after cleaning and prior to use, and only use FDA-cleared (USA) or CE-marked (Europe) sterilization accessories such as sterilization pouches and autoclave trays.

1. Place the handpiece shell, 3 mm and/or 7 mm PBM adapters in a separate single-wrap, self-seal autoclave pouch.
2. Place on an autoclave tray with paper side down; do not stack other instruments on top of the pouch.
3. Place the tray inside the autoclave chamber and set the cycle to 135° C (275° F) for a minimum of 10 minutes with a dry time of 30 minutes. This suggested extended sterilization cycle of 135 degrees C (275 degrees F) for a minimum of 10 minutes with a dry time of 30 minutes is considered by the United States Food and Drug Administration to be a standard sterilization cycle. We recommend sterilizers and accessories (such as sterilization wraps, sterilization pouches, chemical indicators, biological indicators, and sterilization containers) that have been cleared by the USFDA for the selected sterilization cycle specifications.

It is recommended to use a sterilizer and any accessories that are capable of reaching 135 degrees C (275 degrees F) and capable of reaching a 10-minute cycle with a 30 minute dry time such as the Getinge Sterilizer 533LC (FDA 510k #K070657) along with an FDA-cleared sterilization pouch such as Chex-all 3x8”(FDA 510k #K162258).

4. Once the cycle is completed, remove the tray and let the sterilized item cool and dry. The handpiece, 3 mm and/or 7 mm PBM adapters must remain in the sterilization pouch until used in order to maintain sterility.
5. Visually inspect handpiece shell or 3 mm/7 mm PBM adapter to ensure product is not degraded. Below are the criteria for the degradation for the respective items:

A visual and mechanical inspection of the PBM adapters and aluminum handpiece after each sterilization should be conducted to ensure adapters have not degraded and lost performance. Unacceptable deterioration includes cracked glass, delamination of anodized material, a non-uniform circular spot when checking the aiming light on a flat surface and not being able to fully thread onto the handpiece. In the event the adapters have cracked glass or a non-circular aiming light spot, please send the adapters back to the manufacturer for review.

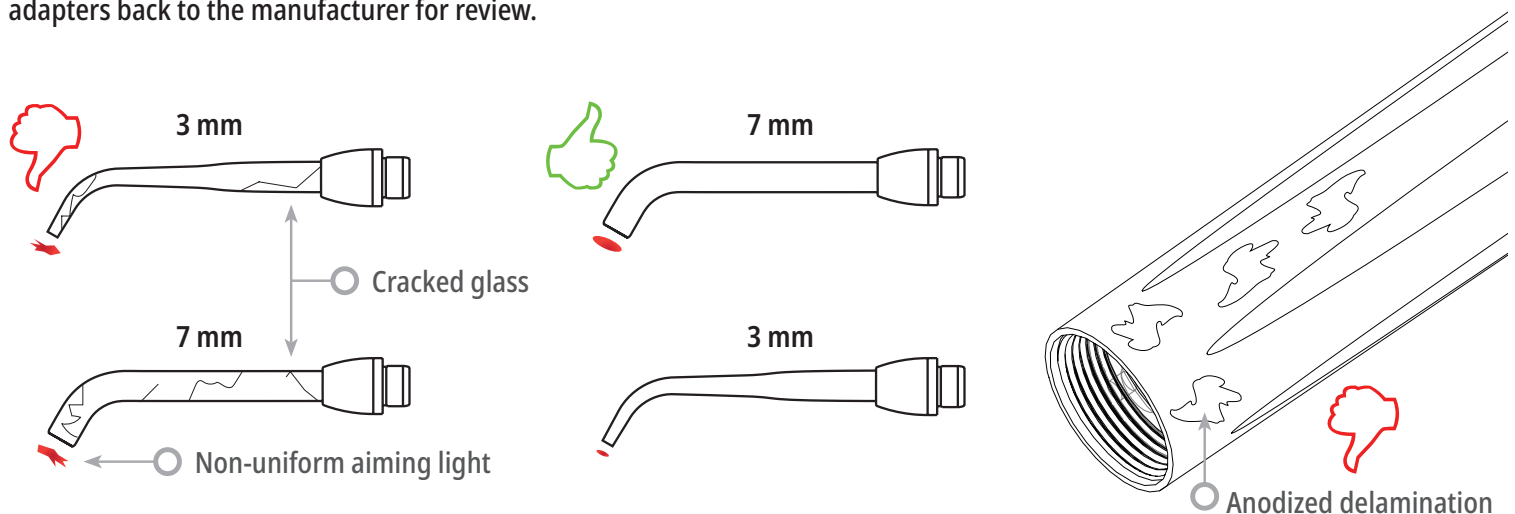

CLEANING AND STERILIZATION PROCEDURES

Remove / reassemble the handpiece shell or 3 mm/7 mm PBM adapter following the instructions below.

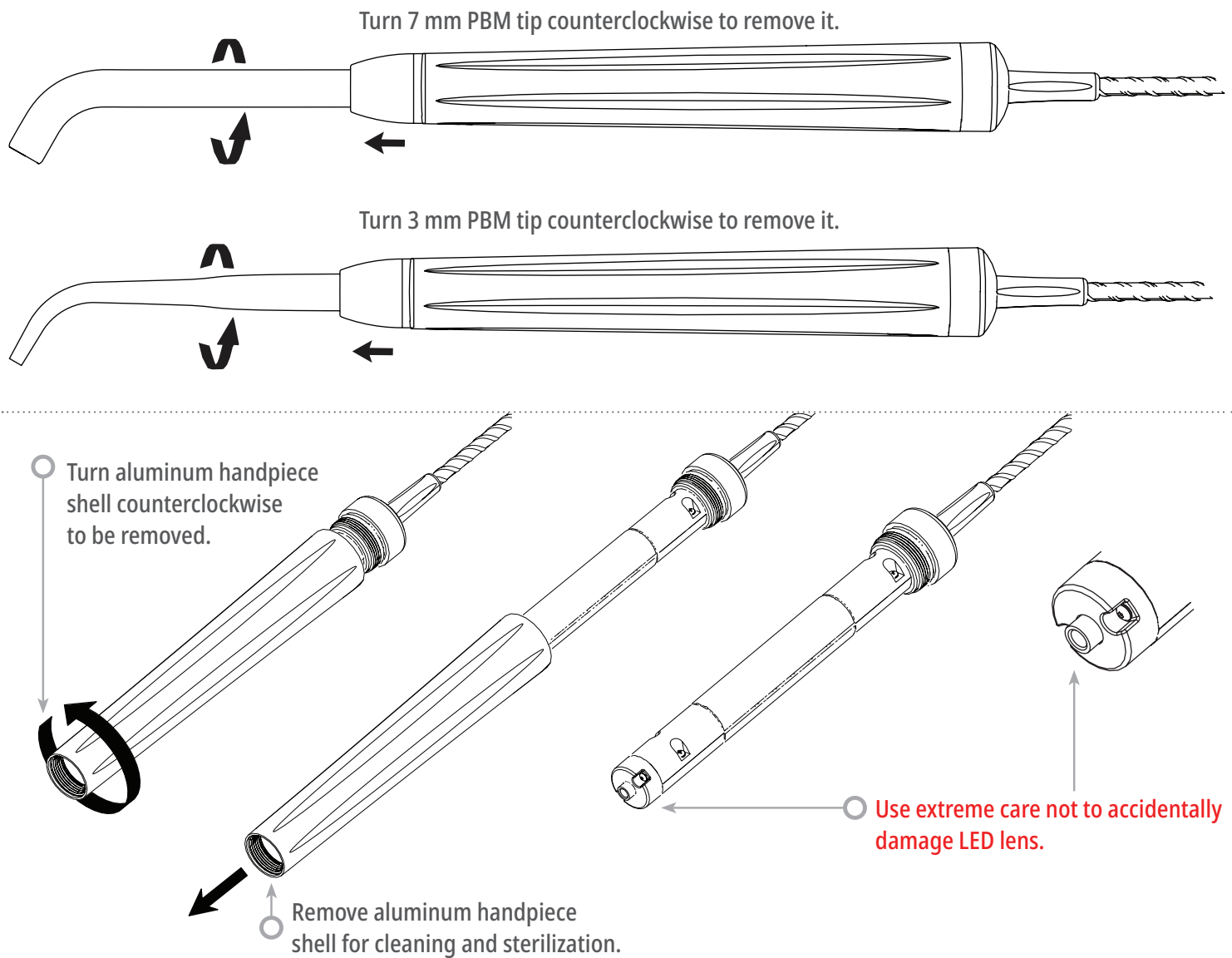

To reassemble, slide the handpiece shell onto the handpiece body and turn clockwise to tighten.

NOTE: The exterior of the laser unit is not routinely contaminated by procedures. The Guided Touch Interface and electroluminescent display should be covered with a protective clear adhesive barrier film, replaceable after each patient. If the exterior of the laser unit should become contaminated, it should be wiped down with CaviWipes, or equivalent product, then re-covered with a new protective plastic cover. We recommend wringing out any cleaning wipes before use to avoid dripping liquid on the laser unit.



DO NOT SPRAY ANY DISINFECTANT DIRECTLY ON THE LASER UNIT, BECAUSE IT WILL DAMAGE THE TRANSPARENT ELECTROLUMINESCENT DISPLAY.

DO NOT USE ABRASIVE MATERIALS TO CLEAN THE LASER OR THE DISPLAY.

PROCEDURAL RECOMMENDATIONS

GUIDELINES

The following procedure guidelines are provided as a guide only and have been developed based on information provided by experienced laser users and educators. Always review the patient's history to evaluate possible contraindication for use of local anesthesia or other complications.

All clinical procedures performed with the Gemini EVO 810+980 soft tissue laser must be subjected to the same clinical judgment and care as with traditional techniques and instruments. Patient risk must always be considered and fully understood before clinical treatment. The clinician must completely understand the patient's medical history prior to treatment.

INDICATIONS FOR USE

The Gemini EVO 810+980 soft tissue laser is intended for the incision, excision, vaporization, ablation, and coagulation of oral soft tissues including marginal and inter-dental gingival and epithelial lining of free gingiva and the following specific indications:

- Excisional and incisional biopsies
- Exposure of unerupted teeth
- Fibroma removal
- Frenectomy
- Frenotomy
- Gingival troughing for crown impressions
- Gingivectomy
- Gingivoplasty
- Gingival incision and excision
- Hemostasis and coagulation
- Implant recovery
- Incision and drainage of abscess
- Leukoplakia
- Operculectomy
- Oral papillectomies
- Pulpotomy
- Pulpotomy as an adjunct to root canal therapy
- Reduction of gingival hypertrophy
- Soft tissue crown lengthening
- Treatment of canker sores, herpetic and aphthous ulcers of the oral mucosa
- Treatment of aphthous ulcers.
- Vestibuloplasty
- Tissue retraction for impression
- Lesion (tumor) removal.

Laser Periodontal Procedures

- Laser soft tissue curettage.
- Laser removal of diseased, Infected, Inflamed and necrosed soft tissue within the periodontal pocket.
- Removal of highly inflamed edematous tissue affected by bacteria penetration of the pocket lining and junctional epithelium.
- Sulcular debridement (removal of diseased, infected, inflamed and necrosed soft tissue in the periodontal pocket to improve clinical indices including gingival index, gingival bleeding index, probe depth, attachment loss and tooth mobility)
- Reduction of bacterial level (decontamination) and inflammation

Pain therapy

- Topical heating for the purpose of elevating tissue temperature for a temporary relief of minor muscle and joint pain and stiffness, minor arthritis pain, or muscle spasm, minor sprains and strains, and minor muscular back pain, the temporary increase in local blood circulation; the temporary relaxation of muscle.

All procedures listed in this manual are safe if performed by a licensed, trained professional. The potential side effects to the patient can include swelling, inflammation, redness of the skin, scarring, tissue pigment changes, and infection after treatment. All of these conditions can be reduced by cautiously following the appropriate aftercare or post-operative care instructions.

FACILITY & ENVIRONMENTAL CONSIDERATIONS

GUIDELINES

In addition to receiving proper training in the use of soft-tissue dental lasers, users should be familiar and experienced with these procedures using electrosurgical devices or traditional instruments before performing them on patients with the Gemini EVO 810+980 soft tissue laser. Non-experienced users should seek appropriate training guidance before attempting clinical treatments with the Laser system.

In order to ensure the safe use of the Gemini EVO 810+980 soft tissue laser in your facility, please check to make sure that the proposed location is compatible with the specifications listed below.

POWER REQUIREMENTS

External AC/DC Power Supply - Use only the provided Gemini EVO laser power supply. Every Gemini EVO laser power supply shows the corresponding label below. DO NOT use any other power supply.

Input Power: 100-240V; 50-60Hz, 1.5A

Output Power: 18 V, 65W



HEATING AND VENTILATION

Operating environmental conditions to be within 10° - 40°C (50° - 104°F), and 95% relative humidity or less. Transportation and storage environmental conditions to be within 0° - 40°C (32° - 104°F), and relative humidity of 95% or less. Atmospheric pressure to be within 70kPa – 106kPa in operating, transportation and storage conditions.

COMBUSTIBLE CHEMICALS AND GASES

All gases that are combustible or support combustion and are used in the operatory area where the Gemini EVO 810+980 soft tissue laser is being operated must be turned off during the procedure. Cleaning supplies or other flammable chemical compounds should be stored in an area away from the surgical site in order to avoid possible combustion. Do not use in the presence of supplemental therapeutic oxygen supplies for patients with respiratory or related diseases.

PLUME EVACUATION

Plume evacuation should be addressed when vaporizing tissues. A high volume vacuum system should be used and 0.1 micron or less high filtration masks that are suitable for virus and bacterial control should be worn by clinicians.



CAUTION: LASER FUME AND/OR PLUME MAY CONTAIN VIABLE TISSUE PARTICULATES

OPERATORY ACCESS DURING LASER USE

Access to the treatment area should be restricted while the lasers are in use. A sign indicating "LASER IN USE" should be placed in a designated area adjacent to the treatment area entry location.

GENERAL SAFETY CONSIDERATIONS

GUIDELINES

Safe use of the Gemini EVO 810+980 soft tissue laser is the responsibility of the entire dental team including the doctor, any system operators, and the dental office safety officer. In order to properly assess the favorable conditions of treatment, below is a pre-treatment checklist to help ensure treatment to your patient is safe:

- Ask the patient about allergy to local or topical anesthetics.
- Make sure the laser warning sign is posted in the operating area.
- Make sure the patient and operator(s) are all wearing laser protective eyewear specific to Gemini EVO laser.
- Have the patient fill out an informed consent form for laser treatment. Form templates are typically available from your laser training provider.
- If performing a non-surgical procedure, use an un-initiated fiber tip.
- If performing a surgical procedure, use an initiated fiber tip.

Adjust the laser power settings as needed to fit the clinical circumstances of the case. The preset procedure settings built into Gemini EVO laser are simply a manufacturer's recommendation. Optimal power level may vary case by case

MARKETING REQUIREMENTS REGARDING MEDICAL DEVICE SAFETY (USA)

The United States Food and Drug Administration (FDA) has control over the sale and use of all medical devices including the Gemini EVO 810+980 soft tissue laser. Manufacturers of products subject to performance standards under the Federal Food, Drug, and Cosmetic Act, Chapter V, Subchapter C - Electronic Product Radiation Control are required to certify compliance with the regulations and furnish various reports to the Center for Devices and Radiological Health (CDRH).

For manufacturers of medical lasers (such as the Gemini EVO 810+980 soft tissue laser system), additional review by the FDA of the safety and effectiveness of the device is required. Companies who intend to market a medical laser or equivalent device must receive authorization from the FDA before the device is permitted into commercial distribution. The premarket notification (510k) process used for the Gemini EVO 810+980 soft tissue laser system is applicable for devices that are documented to be substantially equivalent to existing legally marketed Class II devices.

STATUTORY LICENSURE FOR DENTAL LASER USE

Usually, states or provinces do not have a specific licensure requirement for use of surgical laser devices by dentists. Many states do, however, require hygienists who will be using lasers to attend licensure training that includes both a lecture and hands-on experience.

The license applicants are then required to pass a proficiency test for certification prior to using lasers. These courses are usually taught by members of the Academy of Laser Dentistry who possess instructor credentials. Such training would be appropriate for use of the Gemini EVO 810+980 soft tissue laser system.

OSHA PROVISIONS

Worker safety is the responsibility of the employer and is regulated by OSHA (Occupational Safety and Health Administration), a division of the U.S. Department of Labor. OSHA recognizes ANSI standard Z136.1 as a source for analyzing safety with respect to medical lasers.

GENERAL SAFETY CONSIDERATIONS

For more information see OSHA Technical Manual (TED1- 0.15A) Section III, Chapter 6, 1999. A safety program is recommended for the safety of your patients and office staff in connection with the use of the Laser. It is also recommended to check and comply with applicable state and provincial safety and health organization requirements.

CONTRAINDICATIONS

Exercise caution for general medical conditions that might contraindicate a local procedure. Such conditions may include allergy to local or topical anesthetics, heart disease, lung disease, bleeding disorders, and immune system deficiency, or any medical conditions or medications that may contraindicate use of certain light/laser type sources associated with this device. Medical clearance from patient's physician is advisable when doubt exists regarding treatment.

The Gemini EVO 810+980 soft tissue laser is not indicated for hard tissue procedures. The Laser is attracted to melanin, hemoglobin, and to some extent, water. Avoid prolonged exposure of the energy when working in and around the cervical areas of the tooth. Due to the thin layer of enamel in this area, energy may be absorbed by the hemoglobin in the pulp and pulpal hyperemia may occur. Extended exposure to such energy could cause patient discomfort and even lead to possible pulpal necrosis.

EYE AND SKIN PROTECTION

While the Gemini EVO 810+980 soft tissue laser is in use, doctors, system operators, auxiliary staff, patients, and anyone in the operatory must wear the appropriate safety eyewear that has been designed for use with the 800-plus nm wavelengths associated with lasers. Eye protection must conform to Specification DIN EN207 Annex II of the Directive 89/686/EEC with optical density of OD+5 for the wavelength range of 800nm-1000nm.

Nominal Ocular Hazard Distance (NOHD) is the distance from the source of laser emission to the point where it no longer exceeds its Maximum Permissible Exposure (MPE – highest level of laser radiation to which a person may be exposed without hazardous effects or adverse biological changes in the eyes or skin). The Nominal Hazard Zone (NHZ) is the space within which the level of direct, reflected, or scattered radiation during normal operation exceeds the appropriate MPEs. The outer limit of the NHZ is equal to the NOHD. The NOHD for persons NOT wearing recommended safety glasses is shown in Table 1 below.

Table 1: NOHD (INCHES/CM)

RADIATION SOURCE	MPE $\mu\text{j}/\text{cm}^2$	DIVERGENCE ANGLE	WITHOUT EYE PROTECTION
FIBER OPTIC TIP	1.50	14.5° (+/- 1°)	77 in / 196 cm
PBM 25 mm	1.50	4.5° (+/- 1°)	244 in / 620 cm
PBM 7 mm	1.50	68° (+/- 1°)	16 in / 42 cm
PBM 3 mm	1.50	68° (+/- 1°)	16 in / 42 cm

NEVER POINT THE LASER TIP DIRECTLY AT THE FACE, EYES, OR SKIN OF ANYONE WHILE EMITTING ENERGY.

GENERAL SAFETY CONSIDERATIONS

EMERGENCY SHUTDOWN OPTIONS:

Perform any of these actions to terminate laser emissions in the event of a real or perceived emergency:

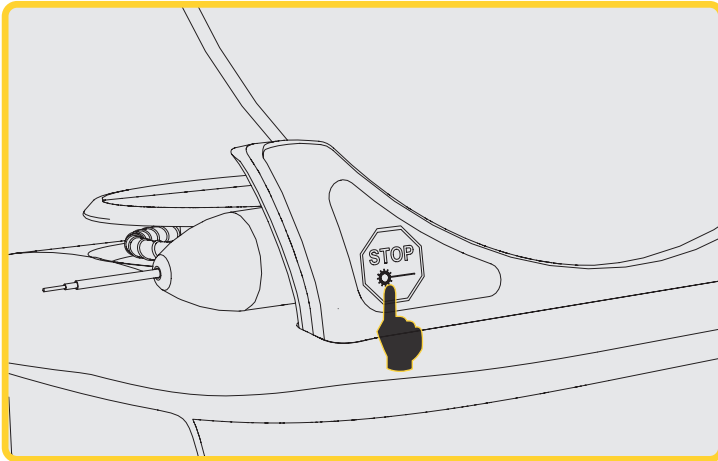

Press the emergency "STOP" button.

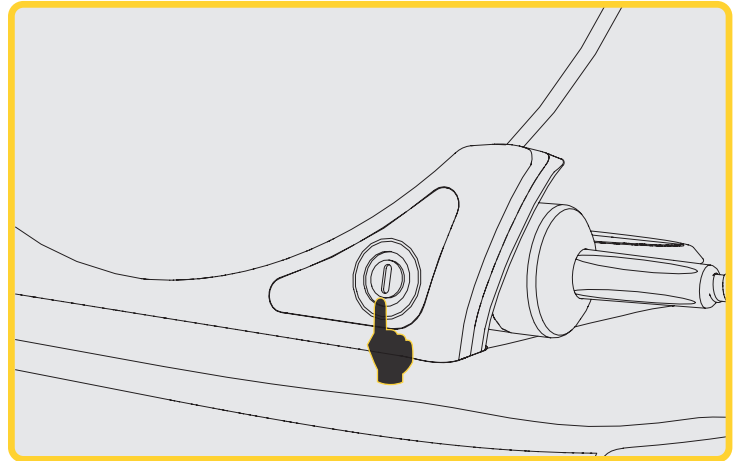

Press the "ON/OFF" button.

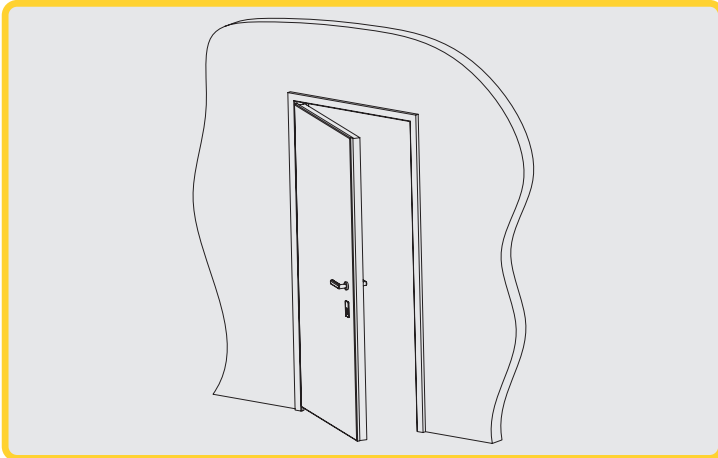

Remote Interlock open circuit deactivates the Laser
(Remote Interlock switch provided by request)



Touch the ACTIVE/STBY Guided Touch Interface selection

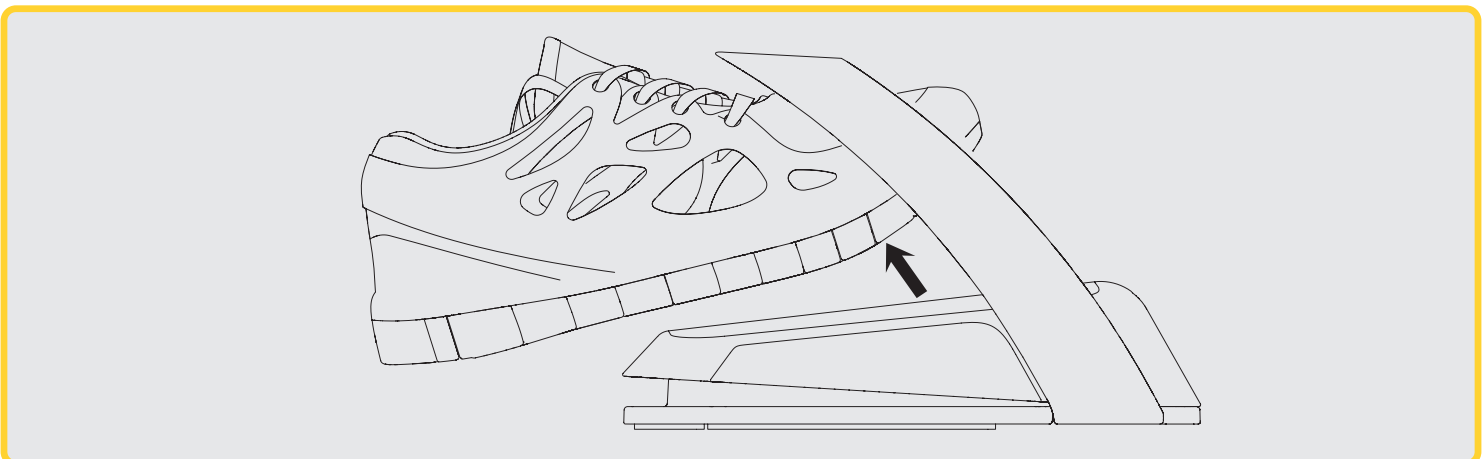

Release your foot from the Activation Pedal

SYSTEM SPECIFICATIONS

Gemini EVO 810+980 Soft tissue laser

Dimensions of Laser Unit	7.5" (L) x 5.7" (W) x 8.2" (H) - 19 cm (L) x 14.5 cm (W) x 21 cm (H)
Dimensions of Foot Pedal:	6.4" (L) x 4.2" (W) x 5.0" (H) - 16.5 cm (L) x 10.8 cm (W) x 13.0 cm (H)
Weight Laser Unit:	2.8 lbs - 1.2 Kg Weight Activation Pedal: 0.6 lbs - 0.2 Kg
Laser classification:	Class IV laser device
Delivery system:	Optical Fiber
Wavelength:	810 nm or 980 nm \pm 10 nm Dual Wavelength \pm 10 nm (50% @ 810 nm / 50% @ 980 nm)
Maximum average power:	810 nm @ 2.0 Watts \pm 20% 980 nm @ 2.0 Watts \pm 20% Dual Wavelength @ 2.0 Watts \pm 20% Peak: Up to 100 W
Aiming beam wavelength:	650 \pm 10 nm
Aiming beam power:	2 mW max
Beam divergence:	254 mrad
Power range:	0.1 Watt to 2.0 Watts Average
Pulse frequency:	20 - 800 Hz
Pulse width:	0.05 ms
Duty cycle:	0.1% - 4%
Voice confirmation:	YES
Power requirements:	Input: 100-240 VAC @ 50 to 60 Hz - 1.5 A Output: 18V DC, 3.6A, 65W
Battery:	14.4 V Rechargeable Lithium Ion
Wireless frequency:	Bluetooth at 2.4 GHz Wi-Fi: 2.4 GHz / WPA2, WPA-Enterprise
Maximum Operating Altitude:	5,000 meters or 16,404 feet
<p>The Gemini EVO 810+980 SOFT TISSUE LASER complies with the following: IEC 60825-1 / EN/S 60601-1 IEC 60601-1-2 IEC 60601-2-22 21 CFR 1040.10 and 1040.11 FCC parts 15 and 18 (47 CFR)</p>	

SERVICE AND TROUBLESHOOTING

CALIBRATION

Re-calibration is recommended every 12 months in order to assure accuracy of optical output power. The Gemini EVO 810+980 soft tissue laser may be returned to the manufacturer for re-calibration, which you can arrange by contacting your distributor. Certain government or corporate entities may require calibration certificates which can also be provided by the manufacturer. A factory calibration record and certificate can be downloaded from your Gemini EVO dashboard.

ADVERSE EFFECTS

If used properly, there are no known adverse effects of using the Gemini EVO 810+980 soft tissue laser. Please thoroughly read and understand all Warnings, Precautions, and Contraindications in this manual prior to use. In the event the laser malfunctions due to exposure to certain environment conditions, magnetic fields, external electrical influences, electrostatic discharge, pressure or variations in pressure, accelerations, and any potential thermal ignition sources, discontinue use and follow the instructions in the service and troubleshooting section of this manual. Additional measures may be necessary such as reorienting or relocating the device.

No separate equipment is recommended to be used to assess the favorable conditions which are acceptable for treatment or to assess the unfavorable conditions which would render a treatment unacceptable or hazardous.

Maximum LASER OUTPUT of laser radiation with the magnitudes of cumulative measurement uncertainty and any expected increase in the measured quantities after manufacture is stated as the standard uncertainty of measurement.

WIRELESS INTERFERENCE

This equipment has been tested and found to comply with the limits for Class B Digital Device, pursuant to Part 15 of the FCC Rules. These limits are designed to provide reasonable protection against harmful interference in a residential installation. This equipment generates and can radiate radio frequency energy and, if not installed and used in accordance with the instructions, may cause harmful interference to radio communications.

However, there is no guarantee that interference will not occur in a particular installation. To determine if this equipment causes harmful interference to radio or television reception, turn the equipment off and on.

ALL OTHER CONDITIONS

In the event that the Gemini EVO 810+980 soft tissue laser fails to operate correctly, and your distributor representative is unable to help, the system will need to be returned to the manufacturer for repair. There are no user-repairable parts available for the device. It is recommended that the system be returned in its original shipping box. If not available, one can be requested at the time you discuss your service incident with your distributor representative.

TROUBLESHOOTING GUIDE

Why is it difficult to see the red aiming light or why is it barely visible?

- CAUSE:**
1. The laser is in STBY mode.
 2. The aiming light under menu is turned off.
 3. The fiber optic cable might be damaged or broken.

- SOLUTION:**
1. Aiming light is only visible under ACTIVE mode. Select ACTIVE in the Guided Touch Interface.
 2. Select menu, then aiming light. With arrows UP/DOWN adjust the aiming light intensity.
 3. Contact Technical Support.

Why is my laser not connecting to Wi-Fi?

- CAUSE:**
1. The unit has never been connected to a wireless network before.
 2. The password my local network changed and I can't connect to the Wi-Fi.
 3. I am not able to find my network while connecting to the Wi-Fi via the App.

- SOLUTION:**
1. Download the Gemini EVO laser mobile app and follow the instructions to make the Wi-Fi connection between your local network and your Gemini EVO device.
 2. Under the Gemini EVO App, select "Add a Device" and follow the instructions. This will enable you to connect with your current network again with a new password.
 3. Contact your network administrator to make sure your local network is broadcasting the Wi-Fi name. Sometimes for security purposes this feature is enabled, preventing outside users to see your local network.

The display is dim or not illuminated?

- CAUSE:**
1. My unit display is barely visible but I can see some of the icons on the top part of the display.
 2. Blank display: The unit lost power.
 3. Only part of my display is visible.

- SOLUTION:**
1. It is likely your unit went into sleep mode. Simply touch anywhere on the Guided Touch Interface to wake up your Gemini EVO laser.
 2. Power the unit on. The unit may have lost power due to low battery in which case the AC power supply should be plugged in.
 3. The unit needs to be sent back to the manufacturer for repair. Contact your distributor representative for return instructions.

TROUBLESHOOTING GUIDE

My activation pedal is not working

- CAUSE:**
1. Unit is not in ACTIVE MOVE.
 2. I am ACTIVE but my Activation Pedal is not working.
 3. Why is my Activation pedal vibrating?

- SOLUTION:**
1. Make sure you select ACTIVE and tap the Activation Pedal once to wake it up.
 2. Even under ACTIVE mode, you need to tap once at the pedal to wake it up.
 3. Gemini EVO laser has a Haptic Sense "HS" feature that enables you to sense small vibrations when the Activation Pedal is active. Under Menu and Haptic Sense "HS" you can select the intensity of the vibrations or completely turn it off.

Photobiomodulation settings are not working and sounds strange

- CAUSE:**
1. After selecting treatment time, nothing happens.
 2. After selecting a treatment time, the Activation Pedal is not activating the start of the procedure.
 3. The unit sounds strange when using the 3 mm and 7 mm tips.

- SOLUTION:**
1. Once treatment time in seconds is selected, you need to select ACTIVE once more to enable the procedure.
 2. If your Activation Pedal is not awake, tap once to turn it on. Then it will activate the procedure and enable multiple procedures consecutively.
 3. Due to the low pulse modulation of power for the 3 mm and 7 mm tips, it is perfectly normal to hear the laser emit a deep pulse sound.

General Questions

For a complete set of troubleshooting questions, videos and images on how your Gemini EVO laser should operate, please go to dashboard.geminievo.com and select the Support tab. Additional information on setup, usability, and settings can be found on www.geminievo.com

For technical support and live troubleshooting with a technician, please contact our equipment support team at equipment.repair@ultradent.com or 1.801.553.4574.

SERVICE AND TROUBLESHOOTING

ERROR MESSAGES

An error message will flash where the Power Indicator is normally displayed.

Software Update Fail



The GEMINI EVO 810+980 Soft Tissue Laser is designed to perform periodic software updates. If during an update Internet connection is lost or unstable, the update may fail. The 'UF' error message shows on the display and user can restart laser unit to re-establish connectivity and resume the update.

Overheating



The GEMINI EVO 810+980 Soft Tissue Laser is designed to perform surgical procedures at a specific temperature. High power and long procedures may cause the Laser Unit to heat up to the temperature limit.

Please wait a few minutes for the temperature to decrease before resuming normal operations.

Activation Pedal Disconnected



The GEMINI EVO 810+980 Soft Tissue Laser is equipped with a long range Bluetooth chip.

Please check the two AA batteries in the Activation Pedal and replace if needed. Press the Activation Pedal once to reactivate the connection with the Laser Unit. The Bluetooth icon on the Activation Pedal will turn blue, and the Bluetooth symbol will appear on the display, when the laser is in Active mode and the Activation Pedal is successfully connected.

Display Communication Error



There will be audible sound "Display Communication Error" should the glass electroluminescent display fail to turn on.

Please plug the AC/DC power supply into the Laser Unit and restart the system by pressing the ON/OFF button. If the problem persists, contact technical support for assistance.

Calibration Error



The GEMINI EVO is capable of sensing the internal laser light with a photodetector. If for any reason your Gemini EVO device goes out of calibration range, the CE ERROR message will be visible. At this time, we recommend contacting our technical support team as the unit might need to be sent for calibration. The certificate of calibration of your Gemini EVO can be downloaded under the Gemini EVO Dashboard/Support Menu.

OVERVIEW AND RECOMMENDATIONS

The Gemini EVO 810+980 soft tissue laser has been developed with Cybersecurity integrated throughout the total-product-lifecycle. Activities such as threat modeling, requirements documentation, penetration testing, and post market management planning have been executed for the device.

The Gemini EVO 810+980 soft tissue laser has been developed with Cybersecurity capabilities such as secure boot and code signing, using industry standard algorithms.

The Gemini EVO 810+980 soft tissue laser supports the ability to provide Cybersecurity Routine Updates and Patches remotely. The device provides notification on the Guided Touch Interface, mobile app and web interface (Dashboard) when a new update is available. The user then has the ability to install the update directly into the device with any of these options.

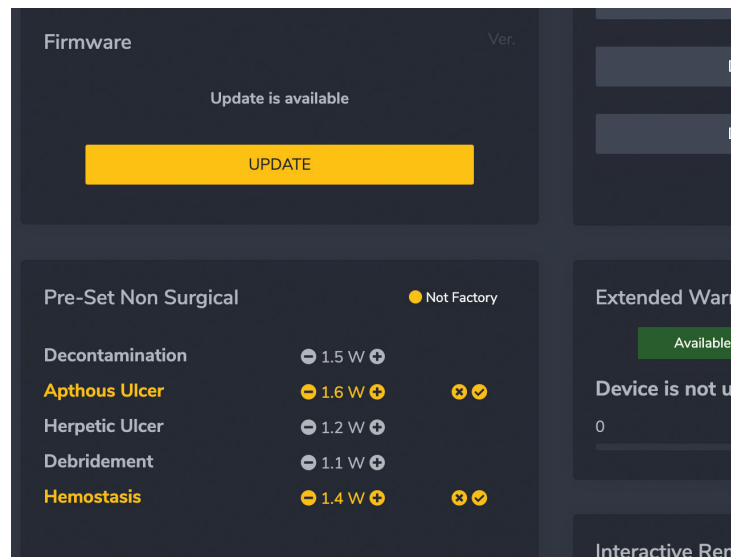
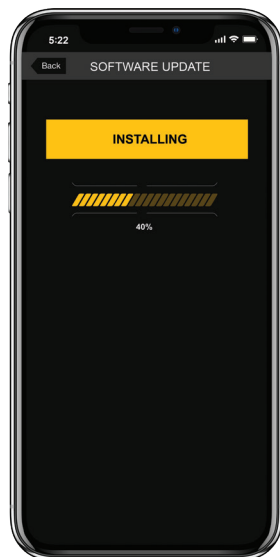
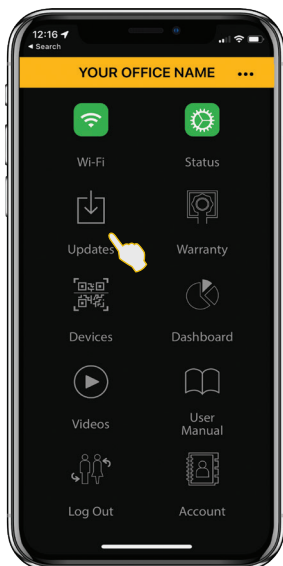
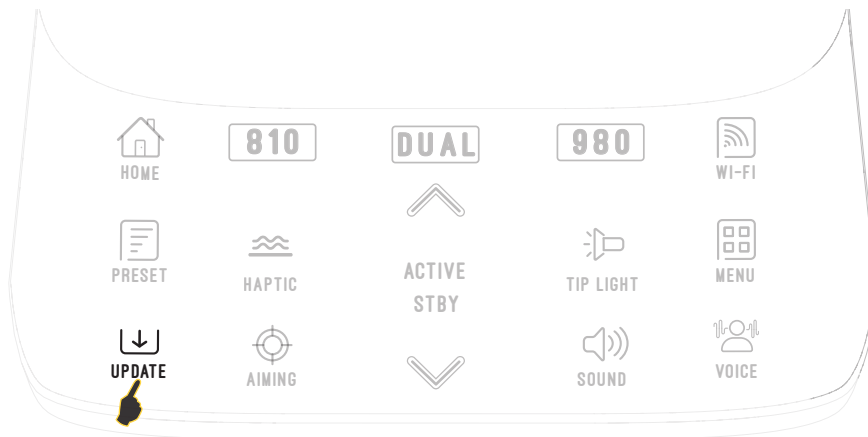

A manufacturers statement on medical device security (MDS2) is available upon request for the Gemini EVO 810+980 soft tissue laser.

ELECTROMAGNETIC ENVIRONMENT GUIDANCE

Electromagnetic Compatibility

Notice: The Gemini EVO 810+980 soft tissue laser complies with all requirements for electromagnetic compatibility according to IEC 60601-1-2: 2014.



CAUTION: Medical electrical equipment needs special precautions regarding electromagnetic compatibility (EMC) and needs to be installed and put into service according to the EMC information provided in the following tables.

Portable and mobile Radio Frequency (RF) communications equipment can affect medical electrical equipment.



WARNING: The use of accessories, other than those specified, except those supplied or sold by Ultradent Products, Inc., as replacement parts for internal or external components, may result in increased EMISSIONS or decreased IMMUNITY of the Gemini EVO 810+980 soft tissue laser.

Accessories: Medical grade power supply - Maximum length 6ft (1.8 meters)

Activation Pedal: Wireless Bluetooth at 2.4 GHz

Description: The Activation Pedal uses Bluetooth BLE 4.0 technology, which operates at a frequency of 2402 to 2480 MHz with TX power of +0dBm and RX sensitivity of -94.8dBm and uses GFSK modulation. The pedal is pre-configured by the manufacturer to only sync with the Gemini EVO Laser Unit that has a matching unique identifier. This prevents interference with other RF wireless technologies that may be present.

As a safety measure, any termination of the Bluetooth link between the Activation Pedal and the Laser Unit during use will result in the immediate termination of any laser emission. Reference the Service and Troubleshooting section of this manual should you encounter any connectivity issues between the Laser Unit and the Activation Pedal.

This device has passed wireless coexistence testing with common devices found in dental practices at a minimum separation distance of 30 cm.

ELECTROMAGNETIC ENVIRONMENT GUIDANCE

Definitions

Emission (electromagnetic): When electromagnetic energy is emitted by a source.

Interference Immunity: The ability of a device or system to work without errors even if there is electromagnetic interference.

Immunity Level: The maximum level of a certain electromagnetic interference that affects a particular device or system, where the device or system remains operative with a certain level of performance.

Electromagnetic Emission

The Gemini EVO 810+980 soft tissue laser is intended for operation in the electromagnetic environment specified below. The customer or user of the Gemini EVO laser should make sure that it is used in such an environment.

EMISSION TEST	COMPLIANCE	ELECTROMAGNETIC ENVIRONMENT – GUIDANCE
RF emissions according to CISPR 11	GROUP 1	The Gemini EVO laser uses RF energy only for its internal function. Therefore, its RF emissions are very low and are not likely to cause any interference in nearby electronic equipment.
RF emissions according to CISPR 11	CLASS A	The Gemini EVO laser is suitable for use in all establishments, including domestic establishments and those directly connected to the public low-voltage power supply network that supplies buildings used for domestic purposes.
Harmonic emissions according to IEC 61000-3-2	CLASS A	
Voltage fluctuations/flicker emissions according to IEC 61000-3-3	COMPLIES	

ELECTROMAGNETIC ENVIRONMENT GUIDANCE

Interference Immunity

The Gemini EVO laser is intended for operation in the electromagnetic environment specified below. The customer or user of the Gemini EVO laser should make sure that it is used in such an environment.

INTERFERENCE IMMUNITY TEST	IEC 60601-1-2 TEST LEVEL	COMPLIANCE LEVEL	ELECTROMAGNETIC ENVIRONMENT GUIDANCE
Electrostatic discharge (ESD) according to IEC 61000-4-2	+/- 2, +/-4, +/- 6, +/-8 kV contact discharge +/- 2, +/-4, +/-8 kV, +/-15 kV air discharge	+/- 2, +/-4, +/- 6, +/-8 kV contact discharge +/- 2, +/-4, +/-8 kV, +/-15 kV air discharge	Floors should be wood, concrete, or ceramic tile. If floors are covered with synthetic material, the relative humidity should be at least 50%.
Electrical fast transient/burst according to IEC 61000-4-4	100kHz repetition +/- 2kV for power supply lines 100kHz repetition +/- 2kV for power input/output lines	100kHz repetition +/- 2kV for power supply lines Not applicable	The quality of the line power supply should be that of a typical commercial or hospital environment.
Surge voltages according to IEC 61000-4-5	± 1 kV differential mode ± 2 kV common mode voltage	± 1 kV differential mode ± 2 kV common mode voltage	The quality of the line power supply should be that of a typical commercial or hospital environment.
Voltage dips, short interruptions and variations of the power supply according to IEC 61000-4-11	Voltage (VAC) 100, 240 over 0% residual with ½ cycles on a phase angle of 0° / 90° / 180° / 270° Voltage (VAC) 100, 240 over 0% residual with 1 cycles on a phase angle of 0° / 90° / 180° / 270° Voltage (VAC) 100, 240 over 70% residual with 25 cycles on a phase angle of 0° / 90° / 180° / 270° Voltage (VAC) 100, 240 over 0% residual with 250 cycles on a phase angle of 0° / 90° / 180° / 270°	Voltage (VAC) 100, 240 over 0% residual with ½ cycles on a phase angle of 0° / 90° / 180° / 270° Voltage (VAC) 100, 240 over 0% residual with 1 cycles on a phase angle of 0° / 90° / 180° / 270° Voltage (VAC) 100, 240 over 70% residual with 25 cycles on a phase angle of 0° / 90° / 180° / 270° Voltage (VAC) 100, 240 over 0% residual with 250 cycles on a phase angle of 0° / 90° / 180° / 270°	The quality of the line power supply should be that of a typical commercial or hospital environment. If the user of the Gemini EVO laser requires it to continue functioning following interruptions of the power supply, it is recommended to have the Gemini EVO laser powered by an uninterruptible power supply or a battery.
Magnetic field of power frequencies (50/60 Hz) according to IEC 61000-4-8	3 A/m	3 A/m	Power frequency magnetic fields should be at levels characteristic of a typical location in a typical commercial or hospital environment

ELECTROMAGNETIC ENVIRONMENT GUIDANCE

IMMUNITY TEST	IEC 60601 TEST LEVEL	COMPLIANCE LEVEL	ELECTROMAGNETIC ENVIRONMENT GUIDANCE
<p>Conducted RF IEC 61000-4-6</p> <p>Radiated RF IEC 61000-4-3</p>	<p>3 Vrms 150 kHz to 80 MHz</p> <p>3 V/m 80 MHz to 2.5 GHz</p>	<p>3 Vrms</p> <p>3 V/m</p>	<p>Portable and mobile radio equipment must not be used within the recommended working clearance from the Gemini EVO laser and its cables, which is calculated based on the equation suitable for the relevant transmission frequency.</p> <p>Recommended separation distance</p> <p>$d = [1.2] \sqrt{P}$</p> <p>$d = [1.2] \sqrt{P}$ at 80 MHz to 800 MHz</p> <p>$d = [2.3] \sqrt{P}$ at 800 MHz to 2.5 GHz</p> <p>Where P is the nominal transmitter output in watts (W) specified by the transmitter manufacturer and d is the recommended working clearance in meters (m).</p> <p>Field strengths from fixed RF transmitters, as determined by an electromagnetic site survey² should be less than the compliance level³ in each frequency range.</p> <p>Interference is possible in the vicinity of equipment bearing the following graphic symbol.</p> 

NOTES

¹ The higher frequency range applies at 80 MHz and 800 MHz.

² Field strengths from fixed transmitters, such as base stations for radio (cellular/cordless) telephones and land mobile radios, amateur radio, AM and FM radio broadcast and TV broadcast, cannot be predicted theoretically with accuracy. An investigation of the location is recommended to determine the electromagnetic environment resulting from stationary HF transmitters. If the measured field strength in the location in which the Gemini EVO laser is used exceeds the applicable RF compliance level above, the Gemini EVO laser should be observed to verify normal operation. If unusual performance characteristics are observed, it may be necessary to take additional measures such as reorientation or repositioning of the Gemini EVO laser.

³ Over the frequency range 150kHz to 80MHz, field strengths should be less than 3V/m.

ELECTROMAGNETIC ENVIRONMENT GUIDANCE

WORKING CLEARANCES

The Gemini EVO laser is intended for operation in an electromagnetic environment where radiated HF interference is checked. The customer or the user of the Gemini EVO laser can help prevent electromagnetic interference by duly observing the minimum distances between portable and/or mobile RF communication devices (transmitters) and the Gemini EVO laser. These values may vary according to the output power of the relevant communication device as specified below.

RATED MAXIMUM OUTPUT POWER OF TRANSMITTER [W]	WORKING CLEARANCE ACCORDING TO TRANSMISSION FREQUENCY [M]		
	150 KHZ TO 80 MHZ	80 MHZ TO 800 MHZ	800 MHZ TO 2.5 GHZ
	$d = [1.2] \sqrt{P}$	$d = [1.2] \sqrt{P}$	$d = [2.3] \sqrt{P}$
0.01	0.12	0.12	0.23
0.1	0.38	0.38	0.73
1	1.2	1.2	2.3
10	3.8	3.8	7.3
100	12	12	23

For transmitters whose maximum nominal output is not specified in the above table, the recommended working clearance in meters (m) can be determined using the equation in the corresponding column, where P is the maximum nominal output of the transmitter in watts (W) specified by the transmitter manufacturer.

Remark 1: The higher frequency range applies at 80 MHz and 800 MHz.

Remark 2: These guidelines may not be applicable in all cases. The propagation of electromagnetic waves is influenced by their absorption and reflection by buildings, objects, and persons.

LABELING

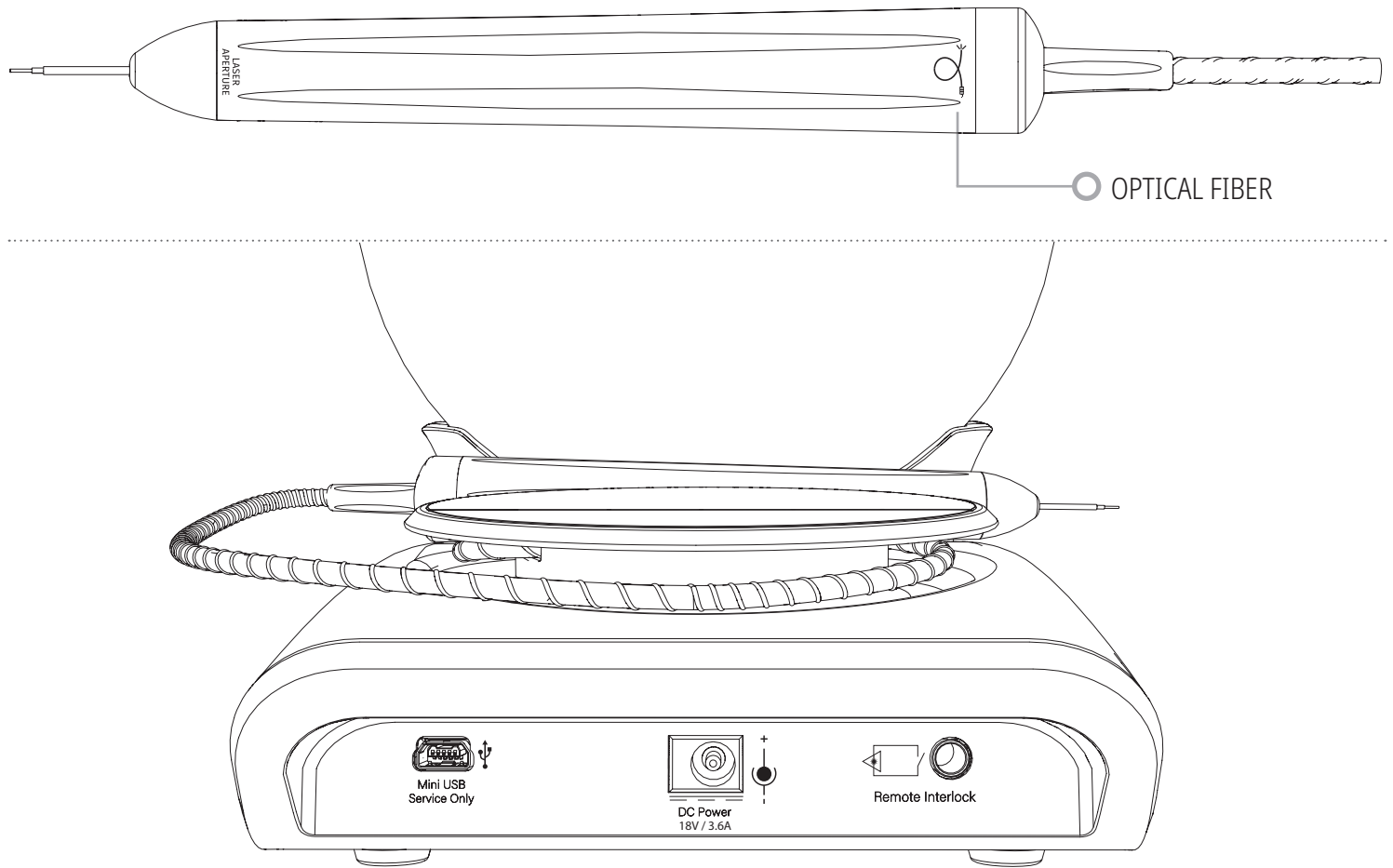







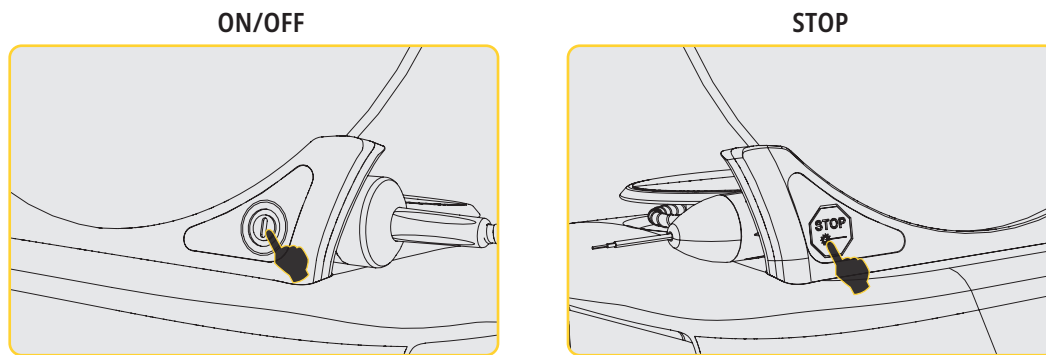





EMERGENCY TERMINATION OF LASER EMISSIONS

The Gemini EVO 810+980 soft tissue laser has been designed with several methods to terminate emission of laser energy in emergency situations.

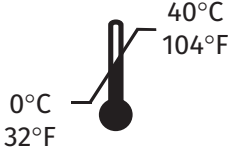
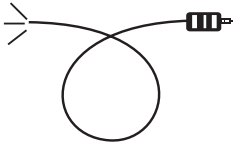
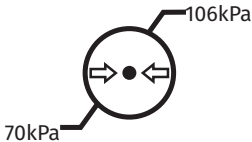
These methods include a power button (ON/OFF) and the emergency (STOP) button located at the front of the laser unit.

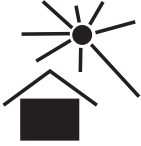

LABELING

SYMBOLS	DESCRIPTION	SYMBOLS	DESCRIPTION
	MANUFACTURER INDICATES WHICH COMPANY MANUFACTURES		SHIP VERTICAL, WITH ARROWS POINTED UPWARD
	DATE OF MANUFACTURE INDICATES THE DATE AND YEAR OF MANUFACTURE		FRAGILE - HANDLE WITH CARE
	CATALOG PART NUMBER INDICATES THE MANUFACTURER PART NUMBER.		DO NOT USE IF PACKAGE IS DAMAGED
	SERIAL NUMBER INDICATES SERIAL NUMBER FOR THE PRODUCT PART		RECOMMENDED STORAGE TEMPERATURE
	OPTICAL FIBER APPLICATOR		ATMOSPHERIC PRESSURE LIMITATION
	LASER APERTURE INDICATES WHERE LASER ENERGY COMES OUT		RELATIVE HUMIDITY RANGE
	WARNING INDICATES POSSIBLE EXPOSURE TO BOTH RED AND INFRARED LASER RADIATION		KEEP AWAY FROM HEAT/SUNLIGHT
	PRESCRIPTION STATEMENT FEDERAL LAW RESTRICTS THIS DEVICE TO SALE BY OR ON THE ORDER OF A DENTIST OR PHYSICIAN OR OTHER LICENSED MEDICAL PRACTITIONER		KEEP DRY

LABELING

UNIT LABEL	PEDAL LABEL
	
SYMBOLS	DESCRIPTION
	<p>TYPE B APPLIED PART THE APPLIED PART IS NOT CONDUCTIVE TO THE PATIENT</p>
	<p>MUST REFER TO USER'S MANUAL</p>
	<p>LASER STOP EMERGENCY SWITCH TO STOP LASER OUTPUT POWER</p>
	<p>NON-IONIZING RADIATION</p>

WARRANTY

Your Gemini EVO laser comes with a 2-year factory warranty. Extended warranty can be purchased and warranty certificates can be downloaded by accessing your **Dashboard** page at dashboard.geminievo.com or under the warranty icon in the iOS and Android Apps.



GEMINI EVO™ | 2-YEAR WARRANTY

810 + 980 DIODE LASER

Seller warrants the Products to be free from defects in materials and workmanship for a period of twenty-four months from the date of shipment, except for consumables. If within such period any Products shall be proved to Seller's satisfaction to be defective, it shall be (i) repaired using new or refurbished parts, or (ii) replaced with a new or refurbished product, at Seller's sole discretion. Such repair or replacement shall be Seller's sole obligation and Buyer's exclusive remedy under this Warranty and shall be conditioned, at Seller's option, upon return of such Products to Seller, f.o.b. its factory. This Warranty only covers Product issues caused by defects in material or workmanship during ordinary consumer use; it does not cover Product issues caused by any other reason, including but not limited to acts of God, modifications of or to any part of the Product, improper testing, assembly, mishandling, misuse, neglect, adjustments, alterations to the products, improper operation contrary to current instructions relating to installation, maintenance or operation, or contrary to industry standards relating to acceptable input power.

THIS WARRANTY IS EXCLUSIVE AND IN LIEU OF ALL OTHER REPRESENTATIONS AND WARRANTIES, EXPRESS OR IMPLIED; AND SELLER EXPRESSLY DISCLAIMS AND EXCLUDES ANY IMPLIED WARRANTY OF MERCHANTABILITY OR FITNESS FOR ANY PARTICULAR PURPOSE. SELLER SHALL HAVE NO OBLIGATION OR LIABILITY TO REFUND ANY PORTION OF THE PURCHASE PRICE AND SHALL NOT BE LIABLE FOR ANY SPECIAL, EXEMPLARY, INCIDENTAL, CONSEQUENTIAL OR PUNITIVE DAMAGES OR LOST PROFITS, OR DAMAGE TO PERSON OR INJURY IN CONNECTION WITH THE PURCHASE OR USE OF THE INSTRUMENT.

800.552.5512 | ULTRADENT.COM



Manufactured by Azena Medical, LLC, 3021 Citrus Circle, Suite 180, Walnut Creek, CA 94598 USA. Made in the USA of U.S. and imported components.
Distributed by Ultradent Products Inc., 505 West Ultradent Drive, South Jordan, Utah 84095



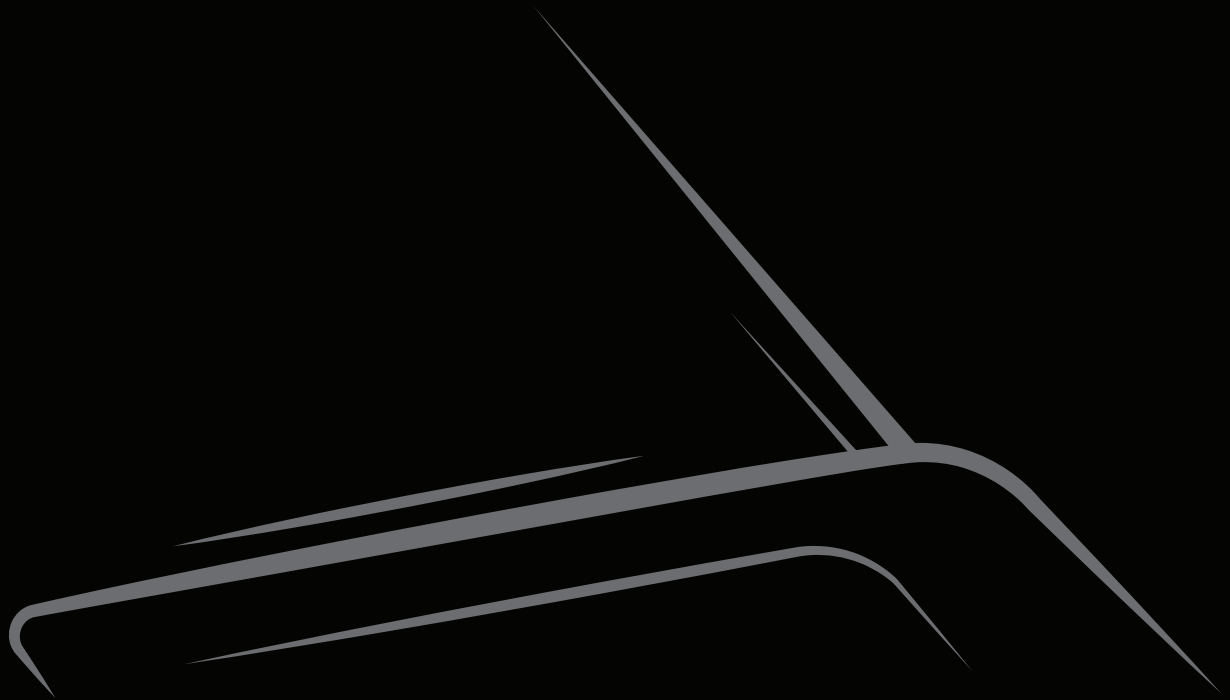

GEMINI **EVO**™

810 + 980 DIODE LASER

800.552.5512 | ULTRADENT.COM



Manufactured by Azena Medical, LLC, 3021 Citrus Circle, Suite 180, Walnut Creek, CA 94598 USA. Made in the USA of U.S. and imported components.
Distributed by Ultradent Products Inc., 505 West Ultradent Drive, South Jordan, Utah 84095

1010000AR03 092322

